

DENSO

Cabin Air Filters

| 2021

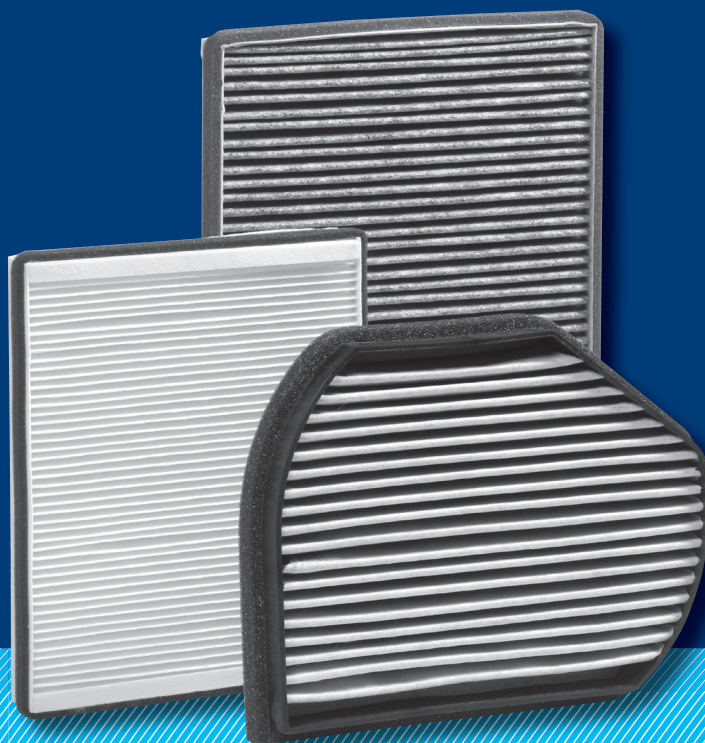

Driven by
Quality

DENSO

A/C Components



DEAC

Directly Quality

DENSO

Cabin Air Filter



DECF

Directly Quality

DENSO

Diesel Fuel Filter



DEDF

Directly Quality

DENSO

Engine Cooling



DEEC

Directly Quality

DENSO

Lambda Sensors



DELS

Directly Quality

DENSO

Spark Plugs | Motorcycle/Small Engine/Marine



DEMC

Directly Quality

DENSO

Engine Management Systems



DEMS

Directly Quality

DENSO

Starters & Alternators



DESA

www.denso-am.eu

Directly Quality

DENSO

Spark Plugs & Glow Plugs



DESG

Directly Quality

60th ANNIVERSARY 1947-2007

DENSO

Wiper Blades | Right Hand Drive | Left Hand Drive



DEWB

Directly Quality

Cabin Air Filter | Table of Contents

GB**Table of Contents**

4	About
5	Filter Types and Replacement
21	Application Tables
41	Cross Reference Chart
71	Photo Guide
105	Abkürzungen

D**Inhaltsangabe**

6	Über unser Sortiment
7	Filterarten & Austausch
21	Anwendungstabellen
41	Querverweistabellen
71	Fotoanweisung
105	Abbreviations

F**Table des matières**

12	A propos de notre gamme
13	Types de filtres & remplacement
21	Tableaux d'affectations
41	Tableau de correspondances
71	Guide photographique
105	Abréviations

E**Sumario**

10	Nuestra gama
11	Tipos de filtro & Sustitución
21	Tablas de aplicación
41	Referencias Cruzadas
71	Guía de fotografías
105	Abreviaturas

I**Sommario**

8	La nostra gamma
9	Tipologie di filtro e il Ricambio
21	Tabelle applicative
41	Tabella di riferimento
71	Guide fotografica
105	Abbreviazioni

SE**Innehåll**

14	Vårt sortiment
15	Filtertyper och utbyten
21	Fordonstabeller
41	Korsreferens
71	Foton
105	Förkortningar

PL**Spis treści**

16	Nasz asortyment
17	Typy filtrów & Wymiana
21	Tabele zastosowań
41	Tabela zamienników
71	Przewodnik ze zdjęciami
105	Skróty

RU**Содержание**

18	Наш ассортимент
19	Типы фильтров и замена
21	Таблицы применений
41	Таблица взаимозаменяемости
71	Руководство- фотогид
105	Сокращения

GB

Fresh Air Comes Naturally with a DENSO Cabin Air Filter

When travelling by car it's vital to know that the air you're breathing in is pure and clean. To eliminate the smells, irritants and pollution that could enter your car from the road, you need a Cabin Air Filter you can trust.

OE quality

DENSO's Cabin Air Filters offer aftermarket customers a wide range of filters designed and manufactured to the highest possible standard – the same Original Equipment (OE) quality that vehicle manufacturers choose for their new cars.

HVAC know-how

As the world's number one OE developer of Heating, Ventilation and Air Conditioning (HVAC) systems, and the world's second largest automotive components brand, DENSO really understands Cabin Air Filter technology.

Better by Design

Quality matters

Without effective cabin air filtration motorists and their passengers can be affected by a variety of potentially harmful air pollutants entering the comfort zone of their car. Pollutants can include dust, soot, pollen, noxious gases and abrasion particles from brakes and tyres. If not eliminated, these can affect eyes, nose and lungs – causing health problems, irritation and discomfort.

Because DENSO Cabin Air Filters offer state-of-the-art, OE quality they address the problem of in-car pollution extremely effectively. They are also subject to our stringent quality control procedures at every stage of production. That not only means a more comfortable driving experience, but better protection against health hazards.

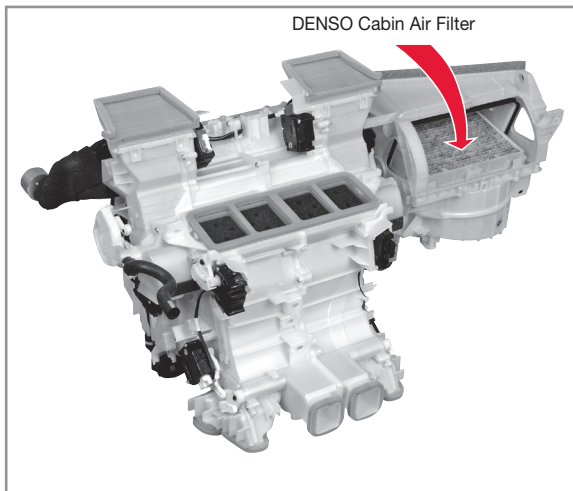

HVAC system

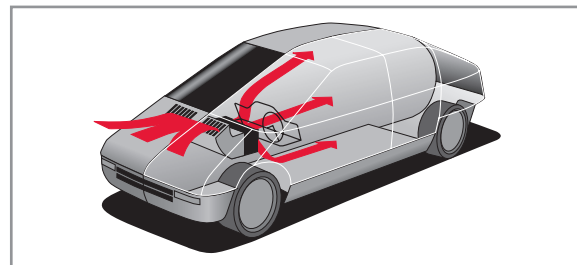

Car Air-Flow

Choice

Engineered to OE standards DENSO's Cabin Air Filter programme offers:

- > 312 part numbers
- > More than 700 applications
- > 90% coverage of the European and Asian car parcs

Particle and Combination filter technology

The DENSO programme includes both Particle Filters and Combination Filters. Our multi-layer filtration systems work to neutralise exhaust gases and other pollutants whilst trapping and holding pollen and dust particles, ensuring air reaching the cabin is clean and safe to breathe. Each air filter reference is individually designed to suit the needs of different vehicles types. What's more, DENSO filters work without causing a drop in air pressure that could potentially damage a vehicle's HVAC systems.

Offering outstanding protection, quality, technology and choice, DENSO Cabin Air Filters add up to a better driving experience.

Superior Technology

DENSO's understanding of HVAC systems means our Cabin Air Filters feature advanced filter technology to ensure a healthier in-car environment. The fleece material we use contains up to five individual layers which trap almost 100% of harmful pollutants and particles, holding them well away from the vehicle interior where they cannot be breathed in. DENSO filters have extremely accurate fitting mechanisms sealing the filter to the housing, increasing filtration efficiency. Their efficient design also protects the HVAC system, benefiting the health of every passenger, and people with allergies.



GB

Filter Types

Particle Filters

Particle Filters from DENSO offer exceptional protection from dust, soot, pollen and particles. Featuring multi-layer fleece material to efficiently remove dust and solid matter, they also have a large dust holding capacity and minimise air flow resistance.

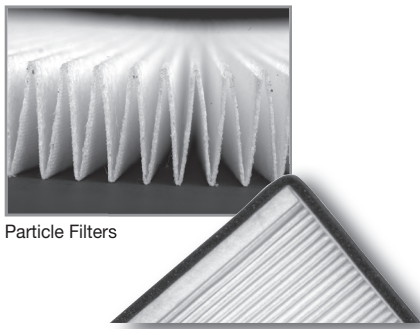

Particle Filters

Combination Filters

DENSO Combination Filters offer all of the blocking, electrostatic and nanofibre technologies of our Particle Filters; trapping almost 100% of dust, pollen and solid particles before they can be inhaled.

But thanks to an additional, activated charcoal layer located inside the filtration material our Combination Filters offer an added advantage.

The result is a cabin atmosphere that always stays fresh, pleasant and healthy to breathe.

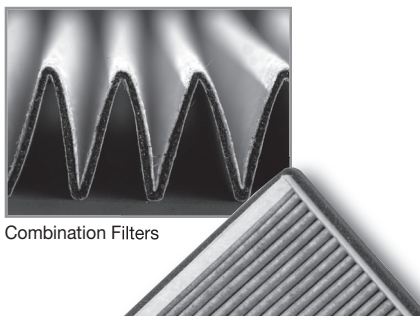

Combination Filters

How do they work?

- > **Removal by blocking** – particles are prevented from entering the cabin by a close meshed, non-woven filter layer. Particles trapped are then deposited into the filter housing.
- > **Removal by electrostatics** – small particles with permanent or temporary charges are attracted and held back by electrostatic interaction.
- > **Nanofibre coatings** – A layer of fine fibres is spun into the filter media, preventing pressure drop.

Replacement

Although most of today's new vehicles are already fitted with Cabin Air Filters, over time the filter becomes clogged with dust and dirt that can eventually be infected by bacteria, mildews and micro-organisms. This makes the filter a potential source of allergens as well as reducing filtration effectiveness and electrostatic charge. There can even be an increase in pressure drop, stressing the HVAC system.

To maintain a fresh, safe in-car environment DENSO recommends replacing the Cabin Air Filter at least once a year, every 10,000 – 15,000 km, or as specified by the vehicle manufacturer, whatever comes first. Only regular replacement ensures the continued filtration efficiency and good HVAC performance that guarantee a more hygienic, comfortable car interior.

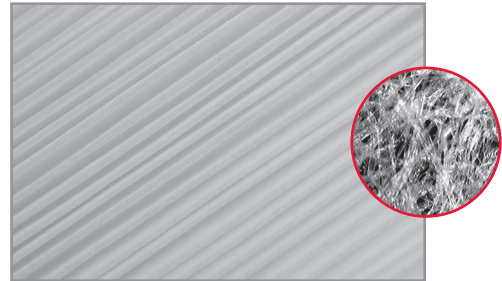

New filter

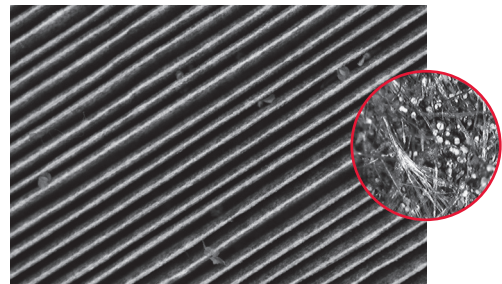

Filter after 15,000 km

Replacement Sense

- > **Get ready for demand** - More than 80% of all European passenger cars are already fitted with Cabin Air Filters, and the trend is rising. This makes timely part replacement an increasingly important and high volume responsibility for the aftermarket.
- > **Health education** - Drivers are rarely aware of the importance of regular Cabin Air Filter replacement – or the consequences of delay. Take time to educate your customers. Prompt action will help to protect their own health, and the well-being of their passengers.
- > **In city and country** - Solid matter, particles, noxious gases and unpleasant smells affect rural as well as urban areas, making Cabin Air Filter replacement important in any environment.

D

Frischlucht ist mit Fahrgastraum-Luftfiltern von DENSO selbstverständlich

Bei Autofahrten muss man sich unbedingt darauf verlassen können, daß die eingeatmete Luft frisch und rein ist. Damit von außen keine Gerüche, Reizstoffe und Fremdkörper ins Fahrzeuginnere eintreten können, wird ein Fahrgastraum-Luftfilter benötigt, auf den Verlass ist.

OE-Qualität

DENSO bietet Kunden im Aftermarket ein breites Spektrum von Fahrgastraum-Luftfiltern, die alle gemäß höchsten Standards entwickelt und produziert werden – in der gleichen Originalausrüstungsqualität (OE), wie sie von Fahrzeugherstellern für Neufahrzeuge spezifiziert wird.

Expertise im Bereich HLK

Weltweit führend in der Entwicklung von Heizungs-, Lüftungs- und Klimaanlage-systemen (HLK) und als weltweit zweitgrößter Zulieferer von automotiven Markenprodukten verfügt DENSO über ein umfassendes Verständnis der Technologie, die für Fahrgastraum-Luftfilter eingesetzt werden muss.

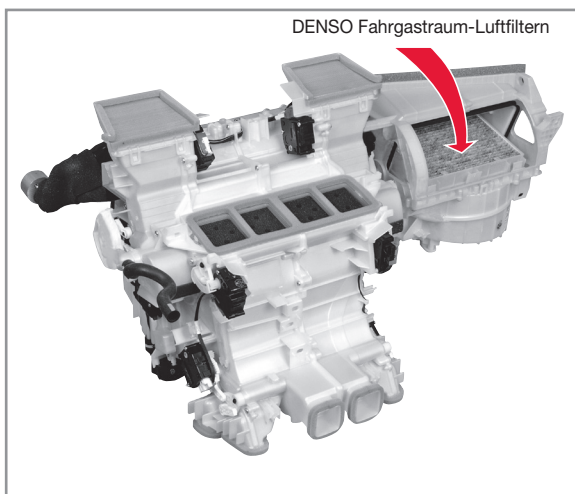

HLK-systeme

Auswahl

Entsprechend OE-Standards gefertigt, bietet das Fahrgastraum-Luftfilterprogramm von DENSO:

- > 312 Artikelnummern
- > Mehr als 700 Anwendungsfälle
- > 90%ige Abdeckung für europäische und asiatische Fahrzeuge

Die Technologie der Partikel- und Kombifilter

DENSO hat sowohl Partikelfilter wie auch Kombifilter in seinem Programm. Unser mehrlagiges Filtrationssystem arbeitet dergestalt, dass Abgase und andere Schadstoffe neutralisiert werden, während Pollen und Staubpartikel abgefangen und festgehalten werden, was gewährleistet, dass die ins Fahrzeug eintretende Luft frisch und rein ist und ohne gesundheitliche Beeinträchtigung eingeatmet werden kann. Jedes Filtermodell ist spezifisch darauf ausgelegt, den Erfordernissen des zugehörigen Fahrzeugtyps zu entsprechen. Und außerdem setzen Filter von DENSO dem Luftstrom keinen Widerstand entgegen, was sonst möglicherweise zu Schäden am HLK-System eines Fahrzeugs führen könnte.

Fahrgastraum-Luftfilter von DENSO bieten ein hervorragendes Maß an Schutzwirkung, Qualität, Technologie und Wahlmöglichkeit und verbessern damit das Fahrerlebnis insgesamt.

Besseres Design

Qualität zählt

Ohne effektive Filtration der in das Fahrzeuginnere eintretenden Luft, sind Fahrer und Beifahrer möglicherweise schädlichen Luftverunreinigungen ausgesetzt, die in den Komfortbereich des Fahrzeugs Eingang finden. Hierzu können Staub, Ruß, Pollen, schädliche Gase und Abriebteilchen von Bremsbelägen und Reifen gehören. Ohne Filterung können diese in Augen, Nase und Lungen gelangen – und damit gesundheitliche Probleme, Reizungen und Unbehagen hervorrufen.

Da Fahrgastraum-Luftfilter von DENSO OE-Qualität bieten, lösen sie das Problem der Luftverschmutzung im Fahrzeuginnere mit hoher Wirksamkeit. Und da strikte Qualitätskontrollen in jedem Produktionsstadium zum Einsatz gelangen, wird nicht nur das Fahrerlebnis komfortabler, sondern zugleich die Gesundheit in höherem Maße geschützt.

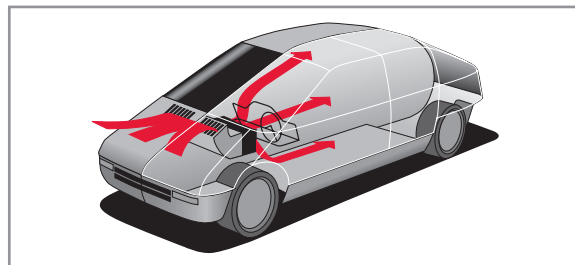

Auto - Luftstrom

Überlegene Technologie

Das Knowhow von DENSO auf dem Gebiet der HLK-Systeme bringt mit sich, dass unsere Fahrgastraum-Luftfilter mit einer fortschrittlichen Filtrationstechnologie arbeiten, die ein gesünderes Innenraumklima gewährleistet. Das von uns verwendete Faserschichtmaterial besteht aus bis zu fünf Einzelschichten, die beinahe 100 % der schädlichen Verunreinigungen und Partikel abfangen, und vom Fahrgastraum entfernt anlagern, wo sie nicht eingeatmet werden können. Filter von DENSO besitzen extrem genau ausgeführte Passungen, die eine Abdichtung des Filters mit dem Filtergehäuse bieten und damit die Wirksamkeit der Filtration erhöhen. Ihr effizientes Design schützt zudem das HLK-System, was der Gesundheit aller Fahrzeuginsassen zugute kommt, insbesondere von Personen, die an Allergien oder Asthma leiden.



D

Filterarten

Partikelfilter

Partikelfilter von DENSO bieten herausragenden Schutz vor Staub, Ruß, Pollen und Schwebstoffen. Für die effektive Filtration von Staub und Festkörperteilchen arbeiten diese Filter mit einem mehrlagigen Faserschichtmaterial, sind in der Lage, große Staubmengen zurückzuhalten und setzen dem Luftstrom ein Mindestmaß an Widerstand entgegen.

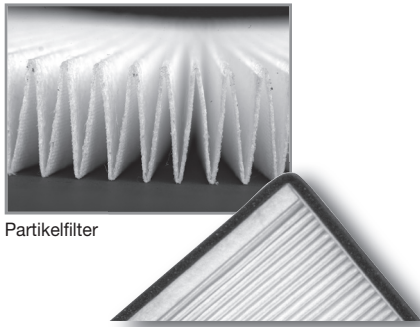

Partikelfilter

Kombifilter

Kombifilter von DENSO arbeiten ebenfalls mit Entfernung durch Rückhaltung und elektrostatische Interaktion sowie einer Nanofaser-Beschichtung - wie unsere Partikelfilter - und halten damit fast 100% an Staubteilchen, Pollen und Festkörperteilchen zurück, ehe diese eingeatmet werden können.

Aber dank einer zusätzlichen Lage Aktivkohle im Filtermedium bieten unsere Kombifilter einen weiteren Vorteil: Sie eliminieren auch unschöne – und oft schädliche – Gerüche und Gase.

Ergebnis ist ein Innenraumklima, das jederzeit frisch und angenehm ist und ohne gesundheitliche Beeinträchtigung eingeatmet werden kann.

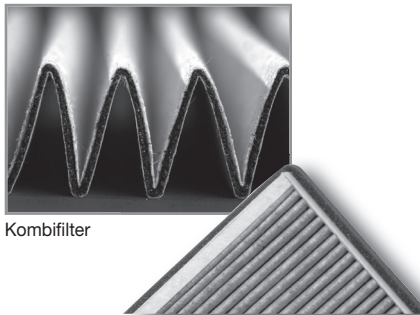

Kombifilter

Wie funktioniert es?

- > **Entfernung durch Rückhaltung** – Partikel werden durch eine feinmaschige Faservlieslage daran gehindert, in den Fahrgastraum einzutreten. Die zurückgehaltenen Partikel werden dann im Filtergehäuse abgelagert.
- > **Entfernung durch Elektrostatik** – Kleinstpartikel mit permanenter oder zeitweiliger Aufladung werden angezogen und durch elektrostatische Interaktion zurückgehalten.
- > **Nanofaser-Beschichtung** – Eine Lage sehr feiner Fasern ist in das Filtermedium eingewirkt und verhindert einen Druckabfall über den Filter.

Austausch

Die meisten heutigen Neufahrzeuge sind schon mit Fahrgastraum-Luftfiltern ausgerüstet. Im Laufe der Zeit setzen sich diese Filter mit Staub und Schmutz zu, worauf sich schließlich Bakterien, Schimmel und andere Mikroorganismen ansiedeln. Damit wird ein solcher Filter zur Quelle möglicher Allergene, seine Filtrationswirksamkeit wird herabgesetzt, seine elektrostatische Aufladung nimmt ab. Zudem kann er dem Luftstrom höheren Widerstand entgegensetzen – und Druckabfälle über den Filter belasten das HLK-System.

Um frisches und sicheres Klima im Fahrzeuginnenraum aufrechtzuerhalten, empfiehlt DENSO, den Fahrgastraum-Luftfilter zumindest einmal jährlich, alle 10.000 – 15.000 km oder gemäß Angaben des Fahrzeugherstellers auszutauschen. Nur der regelmäßige Austausch stellt anhaltende Filtrationswirksamkeit und gute Leistung des HLK-Systems sicher, was bessere Hygiene und höheren Komfort im Fahrgastraum gewährleistet.

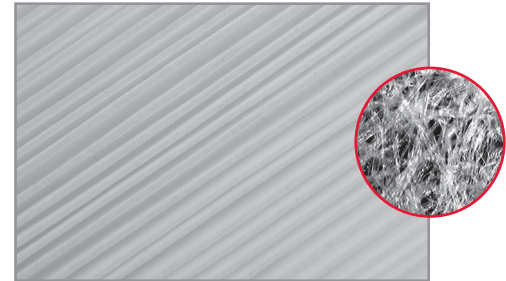

Neuer Filter

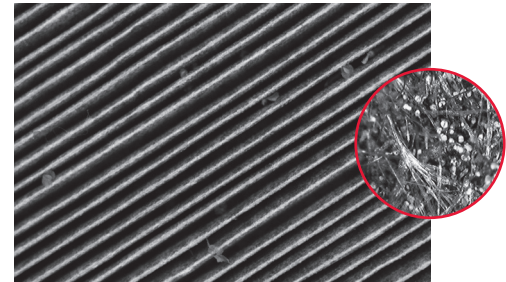

Filter nach 15.000 km

Austausch macht Sinn

- > **Bereiten Sie sich auf die Nachfrage vor** – Mehr als 80 % aller europäischen Personenkraftwagen sind mit Fahrgastraum-Luftfiltern ausgerüstet – Tendenz steigend. Damit wird der zeitgerechte Teileaustausch zu einer stetig wichtigeren und zu einer hohen Volumen repräsentierenden Verantwortlichkeit für den Aftermarket.
- > **Gesundheitsberatung** – Autofahrer sind sich selten der Wichtigkeit eines regelmäßigen Austauschs von Fahrgastraum-Luftfiltern bewusst – geschweige denn der Konsequenzen zu langer Wechselintervalle. Nehmen Sie sich die Zeit Ihre Kunden zu beraten. Promptes Handeln hilft, deren eigene Gesundheit und das Wohlbefinden ihrer Passagiere zu schützen.
- > **In der Stadt ebenso wie auf dem Land** – Feststoffe, Partikel, schädliche Gase und unangenehme Gerüche kommen in der Stadt ebenso wie auf dem Land vor und machen den Austausch von Fahrgastraum-Luftfiltern unabhängig vom Einsatzumfeld des Fahrzeugs wichtig.



Aria pura nella tua auto con i Filtri Abitacolo DENSO

Quando si viaggia in macchina è di fondamentale importanza che l'aria che si sta respirando sia pura e pulita. Per eliminare gli odori, gli agenti irritanti e inquinanti che potrebbero entrare, ti serve un Filtro Abitacolo su cui poter fare affidamento.

Qualità di Primo Equipaggiamento

DENSO offre ai clienti dell'aftermarket un'ampia gamma di Filtri Abitacolo, progettata e realizzata secondo gli standard più elevati del mercato – con la stessa qualità del Primo Equipaggiamento che offriamo ai Costruttori che ci hanno scelto per le loro vetture nuove.

Sistemi di Riscaldamento, Ventilazione e Condizionamento : il nostro know-how

A livello mondiale, DENSO è il primo costruttore di sistemi per il riscaldamento, la ventilazione e il condizionamento e il secondo marchio della componentistica automotive: grazie a ciò conosce perfettamente la tecnologia relativa ai Filtri Abitacolo.

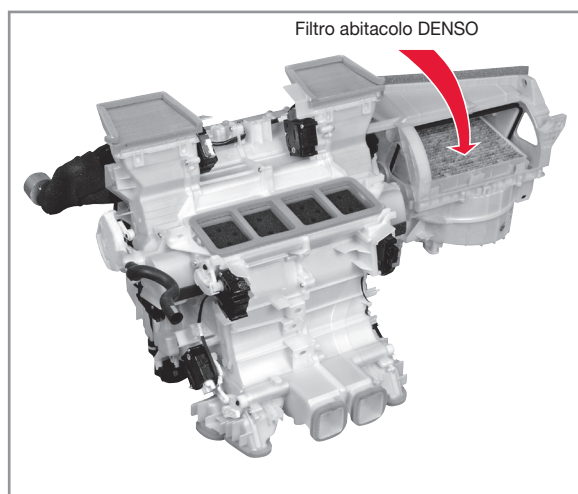

Sistema di Riscaldamento, Ventilazione e Condizionamento

La nostra offerta

Progettata secondo gli standard di Primo Equipaggiamento, la gamma relativa ai Filtri Abitacolo DENSO offre:

- > 312 codici
- > Più di 700 applicazioni
- > Il 90% di copertura del circolante europeo e di quello asiatico

Tecnologia Particellare e a Filtri Combinati

La gamma DENSO include Filtri Particellari e Filtri Combinati. I nostri sistemi di filtrazione multistrato neutralizzano i gas di scarico e altre sostanze inquinanti, intrappolando e trattenendo il polline e le particelle di polvere, garantendo così un'aria pulita e respirabile nell'abitacolo. Ogni applicazione è studiata singolarmente per soddisfare i bisogni di ogni tipologia di veicolo. Inoltre, i filtri DENSO non provocano quelle cadute di pressione dell'aria che potrebbero danneggiare i sistemi di riscaldamento, ventilazione e condizionamento.

I filtri Abitacolo DENSO offrono protezione, qualità, tecnologia e una gamma fuori dal comune, migliorando il confort di guida.

Il meglio dalla progettazione

La qualità conta

Senza un efficace sistema di filtrazione nell'abitacolo, i conducenti e i loro passeggeri possono subire l'aggressione di una varietà di inquinanti potenzialmente dannosi che entrano nella vettura. Gli inquinanti includono polveri, fuliggine, polline, gas nocivi e le particelle generate dall'attrito di pneumatici e freni. Se non vengono eliminati, questi possono intaccare occhi, naso e polmoni – causando problemi di salute, irritazioni e disagi.

I Filtri Abitacolo DENSO rappresentano lo stato dell'arte della tecnologia di Primo Equipaggiamento e sono, quindi, in grado di risolvere in maniera estremamente efficace il problema dell'inquinamento nell'abitacolo. Essi vengono sottoposti a rigidi controlli di qualità in ogni fase produttiva. Ciò comporta non solo un migliore confort di guida ma anche una migliore protezione contro possibili pericoli per la salute.

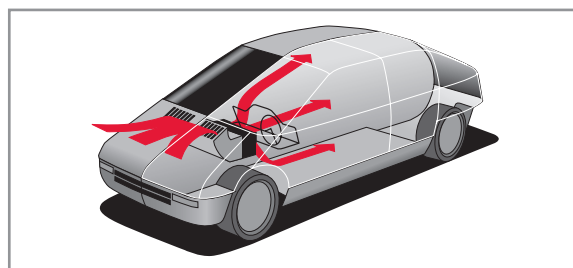

Flusso dell'aria all'interno di una vettura

Tecnologia superiore

La profonda conoscenza DENSO dei sistemi di riscaldamento, ventilazione e condizionamento si traduce in una tecnologia estremamente avanzata dei filtri, in grado di assicurare un ambiente più sano all'interno della vettura. Il tessuto non tessuto che utilizziamo contiene fino a 5 singoli strati che intrappolano quasi il 100% delle particelle e degli inquinanti nocivi, tenendoli lontano dall'interno della vettura in modo che non vengano respirati. Grazie ad accurati meccanismi, i filtri DENSO sono assicurati con precisione all'interno del loro alloggiamento, aumentando così l'efficienza di filtrazione. Il design innovativo protegge, inoltre, il sistema di riscaldamento, ventilazione e condizionamento, a tutto vantaggio della salute dei passeggeri e, in particolare, di quelli che soffrono di allergie.





Tipologie di filtro e il Ricambio

Filtri Particellari

I Filtri Particellari DENSO offrono un'eccezionale protezione contro polveri, fuliggine, polline e particelle. Caratterizzati da un materiale in tessuto non tessuto multistrato, che rimuove efficacemente la polvere e le particelle solide, sono estremamente efficienti nel trattenere la polvere e nel minimizzare la resistenza al flusso d'aria.

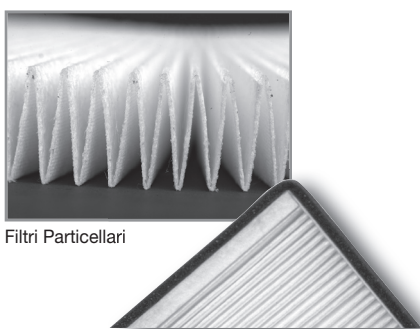

Filtri Particellari

Filtri Combinati

I Filtri Combinati DENSO offrono tutte le tecnologie elettrostatiche, alle nanofibre e di intrappolamento che caratterizzano i nostri filtri particellari. Intrappolano circa il 100% delle polveri, del polline e delle particelle solide prima che queste vengano inalate.

In più, grazie a un secondo strato ai carboni attivi, alloggiato all'interno del materiale di filtrazione, i Filtri Combinati offrono ulteriori vantaggi.

Il risultato è un'aria all'interno dell'abitacolo fresca, piacevole e salubre.

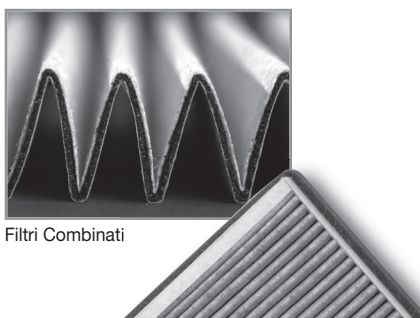

Filtri Combinati

Come funzionano?

- > **Rimozione tramite intrappolamento** – l'ingresso delle particelle nell'abitacolo è inibito da uno strato di tessuto non tessuto a fitte maglie. Le particelle così intrappolate vengono depositate nell'alloggiamento del filtro.
- > **Rimozione elettrostatica** – le particelle più piccole con cariche permanenti o temporanee vengono attratte e trattenute grazie alla presenza di un campo elettrico.
- > **Rivestimento in nanofibre** – Uno strato di fibre sottili viene intessuto nei mezzi filtranti, per prevenire cadute di pressione.

Il Ricambio

Sebbene la maggior parte dei nuovi veicoli sia già dotata di Filtro Abitacolo, questo nel tempo viene ostruito dalle polveri e dallo sporco che possono contenere batteri, muffe e micro-organismi. Ciò rende il filtro una fonte potenziale di allergeni e ne riduce la capacità filtrante e la carica elettrostatica. Tutto ciò potrebbe anche causare un'ulteriore perdita di pressione, sovraccaricando il sistema di riscaldamento, ventilazione e condizionamento.

Per mantenere un ambiente pulito e salubre all'interno dell'abitacolo, DENSO raccomanda la sostituzione del filtro abitacolo almeno una volta all'anno; oppure ogni 10.000-15.000 chilometri; o come specificato dal Costruttore del Veicolo, a seconda di quale di queste situazioni si verifichi per prima. Solo regolari sostituzioni assicurano una duratura efficienza filtrante e buone prestazioni del sistema di riscaldamento, ventilazione e condizionamento, in grado di garantire un interno vettura più igienico e confortevole.

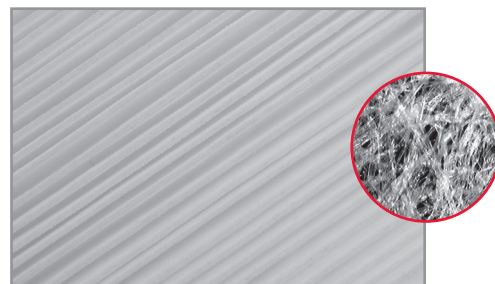

Filtro nuovo

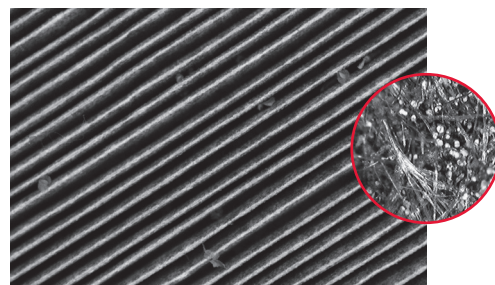

Filtro dopo 15.000 chilometri

Il mercato del Ricambio

- > **Essere pronti alle richieste del mercato**- Più dell'80% del circolante europeo è già dotato di Filtro Abitacolo e il trend è in crescita. La capacità di poter effettuare tempestivamente le sostituzioni rappresenta, quindi, un mercato sempre più importante oltre che un impegno sempre più sentito per l'aftermarket.
- > **Educazione alla salute**- Gli automobilisti sono raramente consapevoli dell'importanza del cambio regolare del Filtro Abitacolo o delle conseguenze di un ritardo nella sostituzione. Dedicare del tempo a responsabilizzare la tua clientela. Intervenire prontamente aiuterà l'automobilista a proteggere la sua salute e il benessere dei suoi passeggeri.
- > **In città e in campagna**- Particelle solide, particelle, gas nocivi e cattivi odori sono presenti tanto in campagna quanto nelle aree urbane. La sostituzione del Filtro Abitacolo risulta quindi importante in ogni contesto.

E

El aire fresco entra naturalmente con un filtro de habitáculo DENSO

Cuando se viaja en automóvil, es vital saber que el aire que se respira es puro y limpio. Para eliminar los olores, las partículas irritantes y la contaminación que pueden entrar desde la carretera, conviene usar un Filtros de habitáculo fiable.

Calidad original

DENSO ofrece a los clientes una gama de filtros de cabina creados y fabricados según las normas más exigentes y con la misma calidad que los fabricantes de vehículos escogen para sus nuevos automóviles.

Tecnología de HVAC

Porque es el principal fabricante mundial de sistemas de calefacción, ventilación y aire acondicionado (HVAC), y la segunda marca más importante del mundo de componentes para la industria automotriz, DENSO conoce muy bien la tecnología de Filtros de aire para cabina.

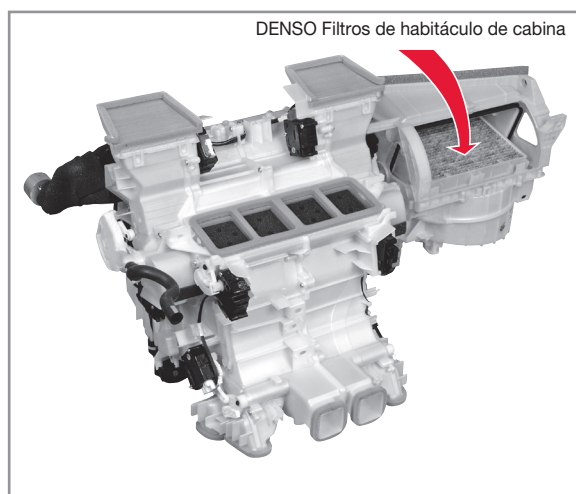

Sistema de la HVAC

Selección

El programa de Filtros de aire de cabina DENSO, creado conforme a los estándares originales ofrece:

- > 312 referencias
- > Más de 700 aplicaciones
- > Una cobertura del 90% para los vehículos en circulación en Europa y Asia

Tecnología de filtros de partículas y de combinación

El programa DENSO comprende tanto filtros de partículas como de combinación. Nuestros sistemas de filtración por numerosas capas neutralizan los gases de escape y otros contaminantes al tiempo que atrapan y retienen el polen y las partículas de polvo, asegurando así que el aire que entra en el habitáculo sea limpio y seguro para respirar. Cada referencia del Filtros de habitáculo se diseña individualmente para que responda a los requisitos de los distintos tipos de vehículos. Es más: los filtros DENSO funcionan sin producir ningún descenso de la presión del aire que podría quizá dañar los sistemas de HVAC del vehículo.

Porque ofrecen protección, calidad, tecnología y elección sobresalientes, los Filtros de aire de cabina DENSO contribuyen a que la experiencia de conducir sea aún mejor.

Mejor por diseño

La calidad importa

Sin una filtración de aire eficaz, los conductores y sus pasajeros pueden verse afectados por diversos contaminantes atmosféricos peligrosos en potencia que invaden la comodidad de su vehículo. Dichos contaminantes pueden ser polvo, hollín, polen, gases nocivos o partículas abrasivas de frenos y llantas. Si no se eliminan, esas partículas pueden afectar ojos, nariz y pulmones y ocasionar problemas de salud, irritación y molestias.

Al ofrecer la más moderna calidad de los equipos originales, los filtros de cabina DENSO resuelven el problema de la contaminación en el coche de manera eficazísima. También les sometemos a nuestros estrictos procedimientos de control de calidad en cada fase de la producción, lo que significa no solo una experiencia de conducción más cómoda sino una protección mejor ante los peligros contra la salud.

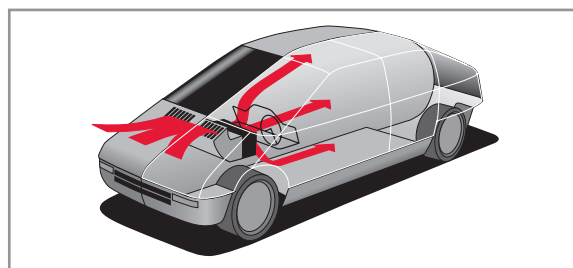

Flujo de aire

Tecnología superior

El que DENSO conozca a fondo los sistemas HVAC significa que nuestros Filtros de aire de cabina cuentan con una avanzada tecnología de filtrado que asegura un ambiente más higiénico en el automóvil. El material lanoso que usamos consta de hasta cinco capas distintas que atrapan casi el 100% de partículas y contaminantes nocivos, manteniéndolos fuera del interior del vehículo, donde no se puedan respirar. Los filtros DENSO tienen unos mecanismos de colocación sumamente precisos que sellan el filtro en su armazón, aumentando la eficacia de la filtración. Asimismo, su eficiente diseño protege los sistemas de HVAC para bien de todos los pasajeros, sobre todo de quienes sufren alergias y asma.



E

Tipos de filtro

Filtros de partículas

Los filtros de partículas DENSO ofrecen una protección excepcional contra polvo, hollín, polen y partículas. Su material compuesto de lana de muchas capas elimina con eficacia el polvo y la materia sólida, tiene gran capacidad para retener el polvo y minimizar la resistencia al flujo de aire.

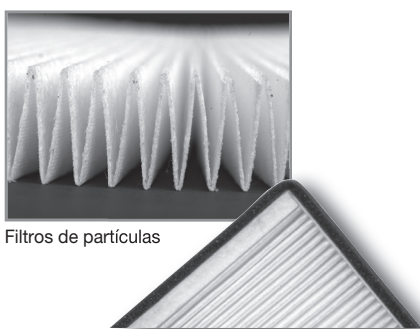

Filtros de partículas

Filtros combinados

Los filtros combinados DENSO ofrecen todas las tecnologías de bloqueo, electrostática y de nanofibras de nuestros Filtros de partículas, capturando casi el 100% del polvo, polen y partículas sólidas antes de poderlas inhalar.

Pero gracias a una capa adicional de carbon vegetal activado, situada dentro del material filtrante, nuestros filtros combinados ofrecen una ventaja extra.

El resultado es que el ambiente del habitáculo está siempre fresco y agradable y es sano para respirar.

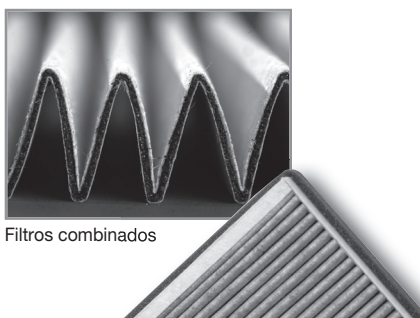

Filtros combinados

¿Cómo funcionan?

- > **Eliminación por bloqueo** – una capa de filtro no tejida de malla tupida, evita que las partículas entren en el habitáculo. Las partículas retenidas se depositan luego en el almacén del filtro.
- > **Eliminación por sistema electrostático** – pequeñas partículas con cargas permanentes o temporales son atraídas y retenidas por interacción electrostática.
- > **Recubrimientos de nanofibra** – En el interior del filtro se hilan una capa de fibras finas que evitan que la presión caiga.

Sustitución

Aunque la mayoría de los vehículos actuales ya cuentan con filtros de polen, con el tiempo el filtro queda lleno de polvo y suciedad y puede estar infestado de bacterias, hongos y microorganismos, hasta convertirse en una fuente posible de alérgenos, además de reducir la eficacia de la filtración y la carga electrostática. Incluso puede aumentar la caída de la presión, forzando el sistema de HVAC.

Para que el ambiente en el automóvil se mantenga fresco y seguro, DENSO recomienda cambiar el filtro al menos una vez al año, cada 15 000 km. o según lo especifique el fabricante del vehículo. Sólo con un cambio periódico se puede asegurar la eficacia continua de la filtración y el buen resultado del HVAC, lo que garantiza un interior del automóvil más cómodo e higiénico.

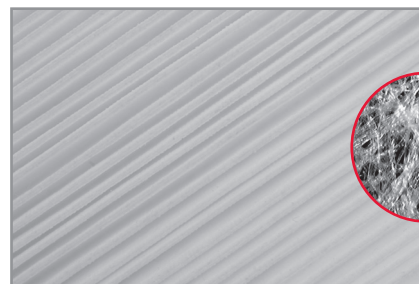

Filtro nuevo

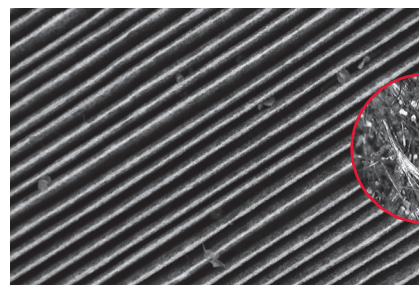

Filtro después de 15 000 km.

Cambiar es de sentido común

- > **Prepárese para la demanda que se avecina** – Más del 80% de todos los vehículos europeos de pasajeros ya cuentan con Filtros de aire de habitáculo y la tendencia va en aumento. Esto hace que el recambio de piezas oportuno sea una responsabilidad cada vez más importante y de gran volumen para el mercado posventa.
- > **Educación en higiene** – Los conductores rara vez se fijan en la importancia de cambiar periódicamente el Filtros de habitáculo de cabina– o de las consecuencias de retrasarlo. Dedique tiempo a educar a sus clientes. Una acción oportuna contribuirá a proteger la salud y el bienestar de sus pasajeros.
- > **En la ciudad y en el campo** – Las materias y partículas sólidas, los gases nocivos, los malos olores afectan lo mismo las zonas rurales que las urbanas, por lo que es importante cambiar el Filtros de habitáculo de cabina.

F

L'air frais circule tout naturellement avec un filtre habitacle DENSO

Lorsque vous circulez en voiture, il est essentiel de savoir que l'air que vous respirez est pur et sain. Afin d'éliminer les odeurs, les irritants et les polluants de la route susceptibles de s'infiltrer dans votre voiture, vous avez besoin d'un filtre habitacle efficace.

Qualité d'équipement d'origine

Les filtres habitacle DENSO proposent aux acteurs du marché de la rechange toute une série de filtres habitacle conçus et fabriqués selon les normes extrêmement élevées – la même qualité d'équipements d'origine que celle choisie par les constructeurs automobiles pour leurs véhicules neufs.

Savoir-faire en matière de groupes de climatisation (HVAC)

En tant que numéro un mondial en matière de développement d'équipements d'origine des systèmes HVAC (Chauffage, ventilation et climatisation), et en tant que deuxième équipementier automobile mondial, DENSO maîtrise parfaitement toute la technologie des filtres habitacle.

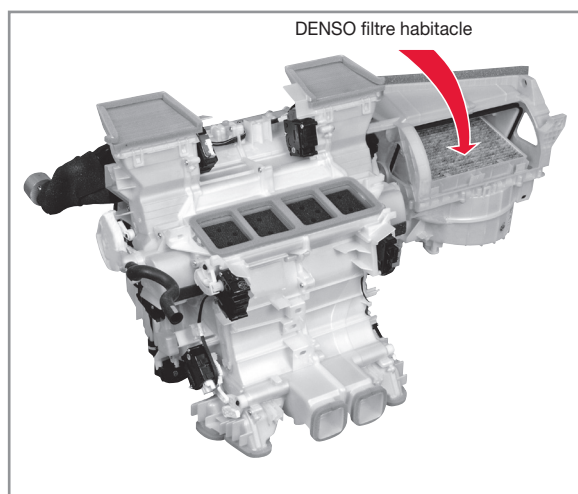

Groupe de climatisation (HVAC)

Vaste choix

Conçue selon les normes d'équipements d'origine, la gamme de filtres habitacle DENSO propose :

- > 312 références
- > Plus de 700 applications
- > 90% de couverture des parcs automobiles européens et asiatiques

Technologie des filtres à particules et combinés

La gamme DENSO comprend des filtres à particules et des filtres combinés. Nos systèmes de filtration multicouches permettent de neutraliser les gaz d'échappement et autres polluants tout en piégeant et en retenant les pollens et les particules de poussière, ce qui garantit que l'air arrivant dans l'habitacle est pur et sain à respirer. Chaque référence de filtre à air est conçue individuellement pour répondre aux besoins des différents types de véhicules. De plus, les filtres DENSO fonctionnent sans provoquer de chute de pression de l'air ce qui risquerait, éventuellement, d'endommager les systèmes HVAC du véhicule.

Présentant une protection, une qualité, une technologie et un choix exceptionnels, les filtres à air d'habitacle DENSO contribuent à améliorer votre sensation de conduite.

Priorité à la conception

Qualité irréprochable

Sans une filtration efficace de l'air de l'habitacle, les automobilistes et les passagers risquent d'être affectés par toute une variété de polluants de l'air potentiellement nocifs, qui s'infiltrent dans la zone de confort de leur voiture. Parmi ces polluants, se retrouvent de la poussière, de la suie, des pollens, des gaz toxiques et des particules d'abrasion provenant des freins et des pneus. S'ils ne sont pas éliminés, ceux-ci risquent d'affecter les yeux, le nez et les poumons, et de provoquer des problèmes de santé, des irritations et des maux.

Les filtres habitacle DENSO, résultats concrets d'une qualité OE à la pointe de la technologie, règlent de façon extrêmement efficace le problème de la pollution dans le véhicule. Ils sont aussi soumis à nos procédures de contrôle qualité rigoureuses à chaque stade de la production. Résultat : non seulement une sensation de conduite dans un confort supérieur, mais une meilleure protection contre les risques de santé.

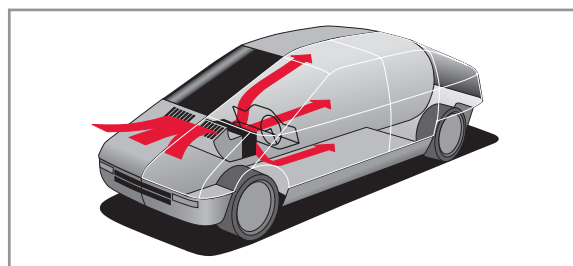

Courant d'air

Technologie supérieure

Grâce à la maîtrise par DENSO des systèmes HVAC, filtres habitacle bénéficient d'une technologie de filtration avancée afin de garantir un environnement plus sain dans le véhicule. Le média utilisé se compose d'un maximum de cinq couches individuelles qui piègent pratiquement 100% des polluants et des particules nocifs, les retenant à l'écart de l'habitacle où ils ne seront pas respirés. Les filtres DENSO sont livrés avec des mécanismes de pose extrêmement précis qui rendent étanche le filtre sur le boîtier, augmentant donc la performance de la filtration. Leur conception judicieuse sauvegarde aussi le système HVAC, protégeant la santé de tous les passagers et en particulier, de tous ceux qui souffrent d'allergies et d'asthme.



F

Types de filtre

Filtres à particules

Les filtres à particules DENSO offrent une protection exceptionnelle contre la poussière, la suie, le pollen et les particules. Composés d'un média multicouches afin d'éliminer efficacement les poussières et les corps solides, ils présentent aussi une grande capacité de retenue des poussières et minimisent la résistance au flux d'air.

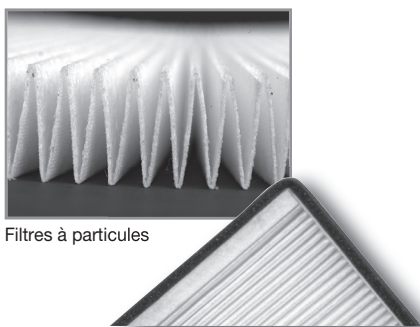

Filtres à particules

Filtres combinés

Les filtres combinés DENSO réunissent toutes les technologies : blocage, électrostatique et nanofibres de nos filtres à particules. Ils piègent près de 100% de poussière, pollens et particules solides avant que ceux-ci ne soient inhalés.

Grâce à une couche de charbon actif supplémentaire située à l'intérieur de la matière de filtration, nos filtres combinés présentent un avantage supérieur. Ils éliminent aussi les gaz et les odeurs désagréables et souvent nocifs.

Il en résulte dans l'habitacle une atmosphère qui reste toujours fraîche, agréable et saine à respirer.

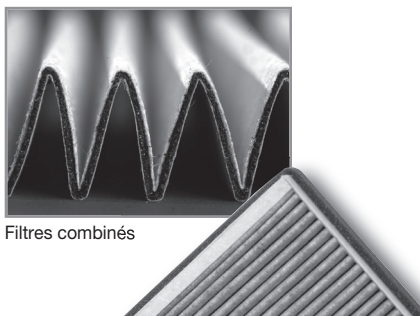

Filtres combinés

Comment fonctionnent-ils?

- > **Élimination par blocage** : une couche de filtrage non tissé à mailles serrées empêche les particules de s'infiltrer dans l'habitacle. Les particules piégées se déposent alors dans le boîtier du filtre.
- > **Élimination par électrostatisme** – les petites particules à charges permanentes ou temporaires sont attirées et retenues par interaction électrostatique.
- > **Enduits de nanofibres** – une couche de fibres fines est tissée dans le média de filtration, afin d'empêcher une chute de pression.

Remplacement

Bien que la plupart des véhicules neufs actuels soient déjà équipés de filtres habitacle, au fil du temps, le filtre risque de se colmater de poussières et d'impuretés qui peuvent en dernier ressort être infestés de bactéries, moisissures et micro-organismes. Ceci fait du filtre une source potentielle d'allergènes et peut aussi réduire l'efficacité de la filtration et les charges électrostatiques. Il peut se produire une chute de pression plus importante imposant des contraintes sur le groupe de climatisation.

Pour maintenir un environnement frais et sûr dans l'habitacle, DENSO recommande de remplacer le filtre habitacle au moins une fois par an, tous les 10 000 à 15 000 km, ou aux intervalles prescrits par le constructeur automobile. Ce n'est qu'en le remplaçant à intervalles réguliers que peuvent être garanties l'efficacité de la filtration continue, et la bonne performance du groupe de climatisation, et donc un habitacle plus hygiénique et plus confortable.

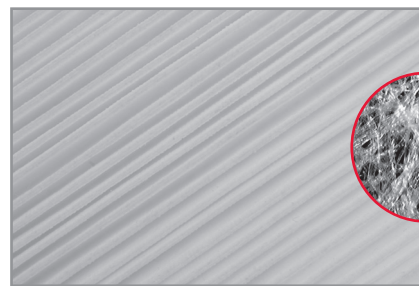

Filtre neuf

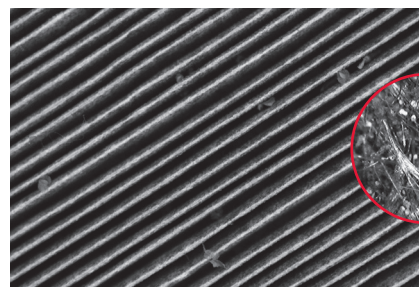

Filtre au bout de 15 000 km

Logique du remplacement

- > **Préparez-vous à répondre à la demande** – Plus de 80% de toutes les voitures de tourisme européennes sont déjà équipées de filtres habitacle, et cette tendance va continuer à augmenter. Par conséquent, pour le marché de la rechange, le remplacement des filtres constitue une opportunité de plus en plus intéressante et un volume potentiel important.
- > **Éducation sanitaire** – Les conducteurs sont rarement informés de l'importance que joue le remplacement régulier des filtres habitacle, ou des conséquences d'un retard dans ce remplacement. Prenez le temps de l'expliquer à vos clients. Un remplacement effectué à temps contribuera à protéger leur santé et celle de leurs passagers.
- > **En ville et à la campagne** - Corps solides, particules, gaz nocifs et mauvaises odeurs affectent l'environnement rural ainsi que l'environnement urbain, ce qui fait qu'il est important de remplacer les filtres habitacle dans n'importe quel environnement.

SE

Frisk luft en självklarhet med DENSO kupéfilter

När man åker bil är det viktigt att veta att luften man andas är frisk och ren. För att ta bort lukter, irriterande ämnen och föroreningar som kan komma in i bilen utifrån krävs ett pålitligt kupéfilter.

Originalkvalitet

DENSO:s kupéfilter erbjuder eftermarknaden tillgång till ett brett urval filter som konstruerats och tillverkats enligt högsta möjliga standard – med samma kvalitet som den originalkomponent fordonstillverkaren valt till sina bilar.

Experter på värme, ventilation och luftkonditionering (HVAC)

DENSO är världens ledande utvecklare av värme-, ventilations- och luftkonditioneringssystem (HVAC) och världens näst största leverantör av fordonskomponenter, så vi kan tekniken bakom kupéfilter.

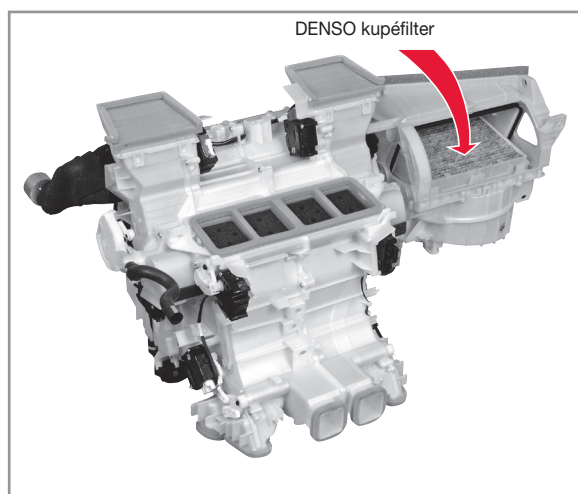

HVAC-system

Stort urval

DENSO:s kupéfiltersortiment, tillverkas i samma kvalitet som originalkomponenterna, erbjuder ett brett sortiment:

- > 312 artikelnummer
- > Fler än 700 fordonsmodeller
- > Täcker in 90 % av bilparken i Europa och Asien

Tekniken i partikel- och kombinationsfilter

DENSO:s sortiment omfattar både partikel- och kombinationsfilter. Våra flerskiktssystem neutraliserar avgaser och andra föroreningar, samtidigt som pollen och damm skiljs av och stannar i filtret så att luften som kommer in i kupén är ren och säker att andas. Alla luftfilter är individuellt konstruerade efter de olika fordonsmodellernas varierande krav. Dessutom skapar DENSO:s luftfilter inget tryckfall som eventuellt kan skada fordonets HVAC-system.

Överlägset skydd, överlägsen kvalitet och teknik, samt ett stort urval, DENSO:s kupéfilter ger en bättre körupplevelse.

Bättre konstruktion

Kvalitet räknas

Utan effektiv luftfiltrering kan förare och passagerare påverkas av skadliga luftföroreningar som kommer in i kupén. Föroreningarna kan vara sot, pollen, skadliga gaser eller partiklar från bromsar och däck. Om de inte avlägsnas kan de påverka ögon, näsa och lungor och orsaka hälsoproblem, irritation och otrivsel.

Eftersom DENSO:s kupéfilter innehåller den modernaste tekniken och håller högsta originalkvalitet är de en extremt effektiv lösning på problemet med föroreningar i bilen. Varje filter genomgår också våra stränga kvalitetskontroller i alla tillverkningssteg. Sammanlagt ger det här inte bara en behagligare körupplevelse, utan också ett bättre skydd mot hälsorisker.

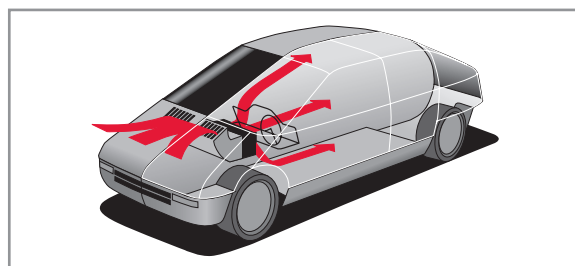

Luftflöde i bilen

Överlägsen teknik

DENSO:s expertkunskaper om HVAC-system innebär att våra kupéfilter bygger på avancerad teknik som ger en hälsosammare kupémiljö i bilen. Ullmaterialet som vi använder består av upp till fem olika skikt som fångar upp nästan 100 % av alla skadliga föroreningar och partiklar, och håller dem borta från kupén, så vi slipper andas in dem. DENSO:s filter har extremt noggrann passning, och fästelement som tätar filtret mot inneslutningen, vilket ökar filtrets effektivitet. Den effektiva konstruktionen skyddar också HVAC-systemet till fördel för passagerarnas hälsa och personer med allergier.



SE

Filtertyper och utbyten

Partikelfilter

Partikelfilter från DENSO ger överlägset skydd mot damm, sot, pollen och partiklar. Filtren har ett ullmaterial i flera skikt som effektivt avlägsnar damm och fasta partiklar. De, har också stor dammlagringskapacitet och ger minimalt luftmotstånd.

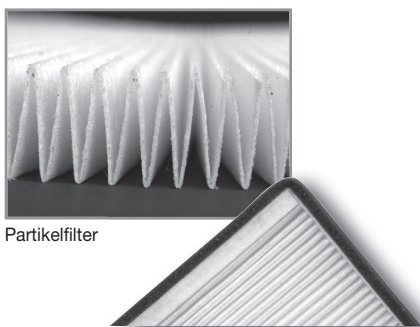

Partikelfilter

Kombinationsfilter

DENSO:s kombinationsfilter innehåller samma teknologier avseende blockering, elektrostatisk laddning och nanofiber som finns i våra partikelfilter och som fångar upp nästan 100 % av damm, pollen och fasta partiklar så att de inte kan andas.

Tack vare ytterligare ett skikt av aktivt kol inuti filtermaterialet ger våra kombinationsfilter ännu en fördel.

Resultatet blir att kupélufven alltid är frisk, behaglig och hälsosam att andas.

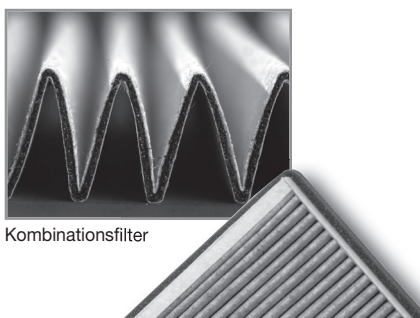

Kombinationsfilter

Hur fungerar de?

- > **Blockering** - partiklarna hindras från att komma in i kupén av ett tätt filterskikt. Infångade partiklar hamnar sedan i filterhuset.
- > **Avlägsnande genom elektrostatisk laddning** - små partiklar med permanent eller temporär laddning attraheras och fångas in genom elektrostatisk växelverkan.
- > **Nanofibrer** - ett skikt av tunna fibrer inspunna i filtermediet förhindrar tryckfall.

Utbyte

Även om de flesta nya bilar idag redan är utrustade med kupéfilter så sätts filtret så småningom igen av damm och smuts som till slut kan infekteras av bakterier, mögel och mikroorganismer. Detta gör filtret till en potentiell källa för allergiframkallande ämnen, samtidigt som filtreringseffekten och den elektrostatiska laddningen försämras. Det kan till och med leda till större tryckfall och högre belastning på HVAC-systemet.

För att hålla kupémiljön fortsatt fräsch och säker. DENSO rekommenderar att kupéfiltret byts ut minst en gång per år, efter 1000 - 1500 mil, eller enligt fordonstillverkarens rekommendationer. Endast regelbundna byten säkerställer filtrets effektivitet och goda HVAC-prestanda, och garanterar en mer hygienisk och behaglig kupé.

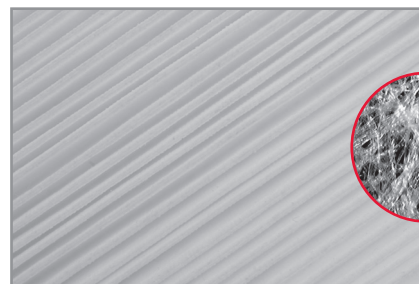

Nytt filter

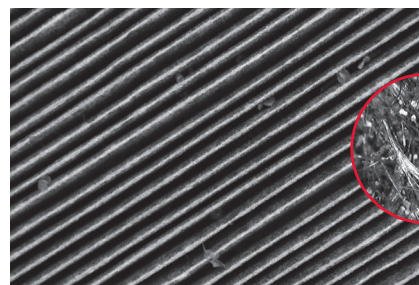

Filtret efter 1 500 mil

Klokt byte

- > **Var beredd på efterfrågan** - mer än 80 % av alla bilar i Europa är redan utrustade med kupéfilter och trenden är ökande. Detta gör schemalagda byten till ett allt viktigare tillfälle till stora försäljningsvolymerna på eftermarknaden.
- > **Hälsoutbildning** - förare är sällan medvetna om hur viktigt det är med regelbundna byten av kupéfiltret - och konsekvenserna av för sena byten. Ta dig tid att utbilda dina kunder. Snabba åtgärder skyddar kundernas egen hälsa och passagerarnas välbefinnande.
- > **Fasta ämnen, partiklar, skadliga gaser och obehagliga dofter** påverkar oss både på landsbygden och i städerna, och byte av kupéfilter är därför viktigt i alla miljöer.

PL

Świeże powietrze dopływa naturalnie z filtra kabinowego DENSO

Podczas jazdy samochodem ważna jest świadomość, że wdychane powietrze jest czyste. Aby wyeliminować nieprzyjemne zapachy, substancje drażniące i zanieczyszczenia, które mogłyby przedostać się do wnętrza samochodu, potrzebujesz filtra powietrza, któremu możesz ufać.

Jakość oryginalnego wyposażenia

Kabinowe filtry powietrza DENSO oferują klientom z rynku wtórnego szeroki asortyment filtrów zaprojektowanych i wyprodukowanych zgodnie z najwyższymi możliwymi normami – jakością OE, czyli taką, jaką wybierają producenci samochodów dla swoich nowych pojazdów.

Wiedza technologiczna HVAC

DENSO, będąc liderem OE w dziedzinie systemów ogrzewania, wentylacji i klimatyzacji (HVAC) i drugą na świecie marką części dla przemysłu motoryzacyjnego, naprawdę rozumie technologię kabinowych filtrów powietrza.

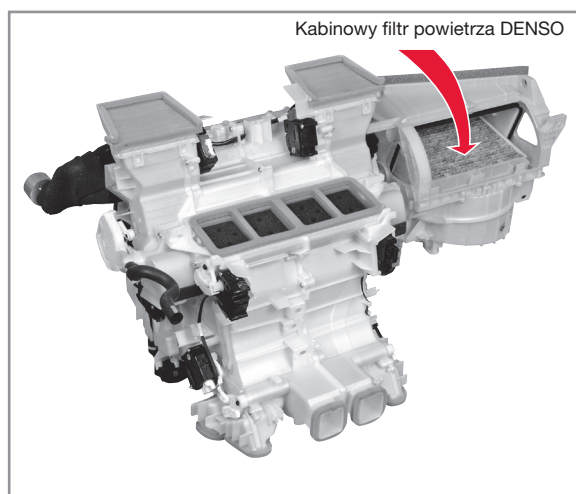

system ogrzewania, wentylacji i klimatyzacji

Wybór

Zaprojektowany zgodnie z normami oryginalnego wyposażenia (OE) program kabinowych filtrów powietrza DENSO zapewnia:

- > 312 pozycji katalogowych
- > ponad 700 zastosowań
- > 90% pokrycie rynku motoryzacyjnego w Europie i Azji

Technologia filtrów standardowych i filtrów z węglem aktywnym

Program DENSO obejmuje zarówno filtry standardowe, jak i filtry z węglem aktywnym. Nasze wielowarstwowe systemy filtracyjne neutralizują spaliny i inne zanieczyszczenia, zatrzymując jednocześnie pyłki kwiatowe i cząsteczki kurzu. Powietrze, które dostaje się do kabiny jest czyste i można nim bezpiecznie oddychać. Każda pozycja katalogowa jest indywidualnie zaprojektowana pod kątem potrzeb różnych typów pojazdów. Co więcej, w filtrach DENSO nie następuje spadek ciśnienia powietrza, który jest potencjalnie niebezpieczny dla systemów HVAC pojazdu.

Kabinowe filtry powietrza DENSO, oferując wyjątkową ochronę, jakość, technologię i wybór, przyczyniają się do podwyższenia jakości jazdy.

Lepszy projekt

Aspekty jakości

Bez skutecznej filtracji powietrza doprowadzanego do kabiny, kierowca i jego pasażerowie mogą być narażeni na różne potencjalnie szkodliwe zanieczyszczenia powietrza, które przedostają się do strefy komfortu pojazdu. Zanieczyszczenia mogą występować w postaci kurzu, pyłków kwiatowych, trujących gazów i cząstek powstałych w wyniku ścierania się okładzin hamulcowych i opon. Substancje te, jeśli nie zostaną wyeliminowane, mogą działać na oczy, nos i oskrzela, powodując problemy zdrowotne, podrażnienia i poczucie braku komfortu.

Kabinowe filtry powietrza DENSO oferują najnowocześniejsze rozwiązania jakości oryginalnego wyposażenia (OE), więc rozwiązują problemy związane z zanieczyszczeniami we wnętrzu samochodu wyjątkowo skutecznie. Podlegają również naszym surowym procedurom kontroli jakości na każdym etapie produkcji. Oznacza to nie tylko większy komfort jazdy, ale także lepszą ochronę przed zagrożeniami zdrowotnymi.

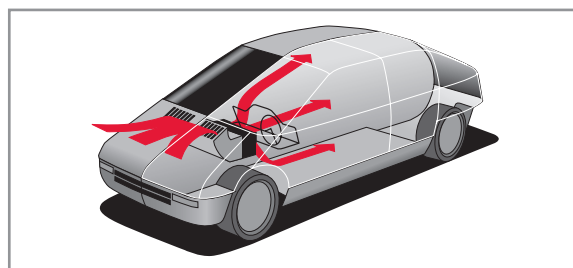

strumien powietrza w pojeździe

Najwyższy poziom technologiczny

Wiedza DENSO w dziedzinie systemów HVAC oznacza, że nasze kabinowe filtry powietrza korzystają z zaawansowanej technologii w celu zapewnienia zdrowszego środowiska we wnętrzu samochodu. Używane przez nas włókniny składają się z maksymalnie 5 warstw, które zatrzymują prawie 100% szkodliwych zanieczyszczeń i cząstek stałych, niedopuszczając, aby trafiły one do wnętrza pojazdu a następnie przedostały się do płuc pasażerów. Filtry DENSO mają wyjątkowe precyzyjne mechanizmy montażowe, które zapewniają szczelność między filtrem a obudową, zwiększając sprawność filtracji. Wydajna konstrukcja chroni również system HVAC, wpływając korzystnie na zdrowie każdego pasażera, a szczególnie osób cierpiących na uczulenia i astmę.



PL

Typy filtrów

Filtry standardowe

Filtry standardowe z firmy DENSO oferują wyjątkową ochronę przed kurzem, sadzą, pyłkiem kwiatowym i cząstkami stałymi. Filtry, wyposażone w wielowarstwową włókninę w celu skutecznej eliminacji kurzu i cząstek stałych, charakteryzują się bardzo dużą pojemnością i minimalnym oporem przepływu powietrza.

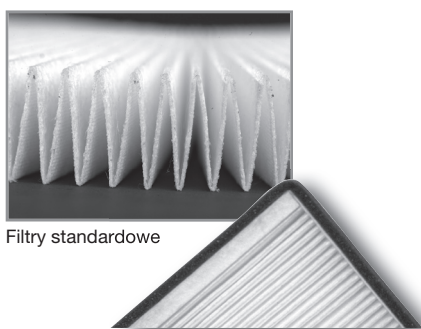

Filtry standardowe

Filtry z węglem aktywnym

Filtry z węglem aktywnym DENSO wykorzystują wszystkie technologie blokowania, elektrostatyczne i oparte na nanowłóknach, stosowane w naszych filtrach standardowych, zatrzymując prawie 100% kurzu, pyłków kwiatowych i cząstek stałych i niedopuszczając, aby dostały się do układu oddechowego.

Dzięki uzupełniającej warstwie węgla aktywnego we wkładzie filtra, nasz filtr z węglem aktywnym oferuje dodatkowe korzyści.

Filtr powoduje, że atmosfera w kabinie jest zawsze świeża, przyjemna i zdrowa.

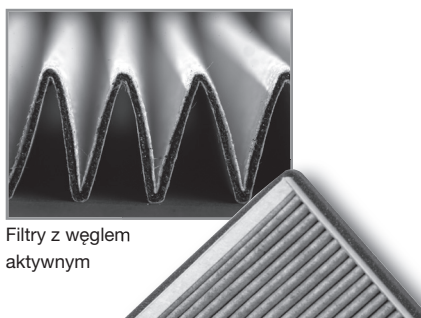

Filtry z węglem aktywnym

Sposób działania filtrów

- > **Eliminacja przez blokowanie** – cząstki, zanim dostaną się do kabiny, zatrzymywane są przez zwartą gęstą warstwę włókniny. Zatrzymane cząstki gromadzone są w obudowie filtra.
- > **Eliminacja elektrostatyczna** – małe cząsteczki o stałym lub tymczasowym ładunku elektrycznym są przyciągane i zatrzymywane w wyniku działania sił elektrostatycznych.
- > **Powłoka z nanowłókien** – warstwa cienkich włókien nawinięta na wkład filtra zapobiega spadkowi ciśnienia.

Wymiana

Mimo że większość współczesnych nowych samochodów jest już wyposażona w kabinowe filtry powietrza, z upływem czasu filtr zapycha się kurzem i zanieczyszczenia w filtrze mogą zostać zaatakowane przez bakterie, pleśń i mikroorganizmy. Może to spowodować zmniejszenie skuteczności filtracji i zmniejszenie ładunków elektrostatycznych oraz sprawić, że filtr stanie się potencjalnym źródłem alergenów. Może być również przyczyną większego spadku ciśnienia obciążającego system HVAC.

Aby zachować świeżą, bezpieczną atmosferę w pojeździe DENSO zaleca wymianę kabinowego filtra powietrza co najmniej raz w roku, co (10 000) – (15 000) km lub zgodnie z zaleceniami producenta samochodu. Co nastąpi najpierw. Tylko systematyczna wymiana zapewnia stałą sprawność filtracji i dobre osiągi systemu HVAC, które gwarantują bardziej higieniczne i wygodniejsze wnętrze samochodu.

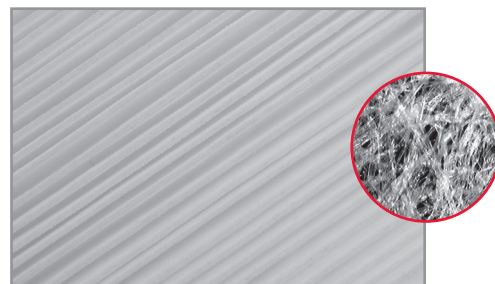

Nowy filtr

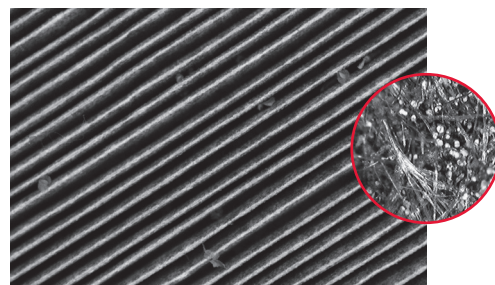

Filtr po 15 000 km

Znaczenie wymiany

- > **Przygotuj się na popyt** – ponad 80% wszystkich samochodów osobowych w Europie wyposażonych jest w kabinowe filtry powietrza i jest to trend rosnący. To sprawia, że coraz większe znaczenie ma wymiana części w odpowiednim czasie i oznacza dużą odpowiedzialność dla rynku wtórnego.
- > **Edukacja zdrowotna** – kierowcy rzadko zdają sobie sprawę ze znaczenia systematycznej wymiany kabinowych filtrów powietrza lub ze skutków opóźnienia. Poświęć czas na edukację swoich klientów. Niezwłoczne działanie pomoże ochronić zdrowie kierowców i pasażerów.
- > **W mieście i na wsi** – cząstki stałe, trujące gazy i nieprzyjemne zapachy występują zarówno na wsi, jak i w mieście, powodując, że wymiana kabinowego filtra powietrza jest ważna w każdym otoczeniu.

RU

Свежий воздух – это естественно с салонным фильтром DENSO

Передвигаясь на автомобиле, очень важно знать, что воздух, которым вы дышите, чистый и свежий. Чтобы устранить запахи, пыль и раздражающие вещества, вам нужен салонный фильтр, которому вы можете доверять.

Оригинальное качество

Программа салонных фильтров DENSO предоставляет потребителям широкий ассортимент фильтров, разработанных и производимых по самому высокому стандарту из всех возможных – качеству оригинального оборудования (OE), которое выбирают производители для своих машин.

Ноу-хау DENSO

Будучи номер один в мире производителей систем климат-контроля и вторым по величине в мире брендом среди производителей автомобильных компонентов, DENSO по-настоящему хорошо понимает технологию салонных фильтров.

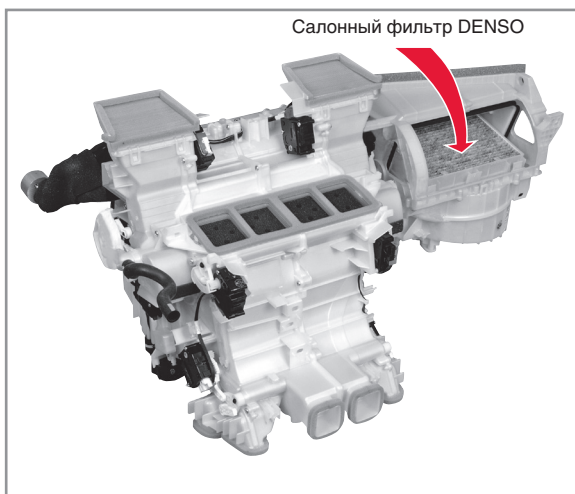

Салонный фильтр DENSO

Система климат-контроля

Выбор

Созданная в соответствии со стандартами OE программа салонных фильтров DENSO предлагает:

- > 312 наименований
- > более 700 применений
- > 90% покрытия европейского и азиатского парка автомобилей

Технология пылевых и комбинированных фильтров

Программа DENSO включает как пылевые, так и комбинированные фильтры. Наши многослойные системы фильтрации нейтрализуют выхлопные газы и другие раздражители, одновременно улавливая и удерживая пыльцу и частицы пыли, и гарантируя, что воздух, поступающий в кабину, чистый и безвредный для дыхания. Каждый тип фильтра разработан индивидуально под конкретный автомобиль. Более того, фильтры DENSO не вызывают падения давления, которое потенциально может повредить систему климат-контроля.

Предлагая выдающуюся защиту, качество, технологию и выбор, салонные фильтры DENSO повышают удовольствие от езды.

Лучше по конструкции

Значение качества

Без эффективной очистки воздуха в салоне водитель и пассажиры могут подвергаться разнообразным опасным воздушным загрязнениям. Это могут быть пыль, сажа, пыльца растений, вредные газы и частицы от износа тормозов и шин. Если их не устранить, они могут причинять вред глазам, носу, легким, вызывая проблемы со здоровьем, раздражение и дискомфорт.

Так как салонные фильтры DENSO предлагают современное качество OE, они борются с проблемой загрязнений внутри салона чрезвычайно эффективно. Так же они подвергаются тщательному контролю на всех стадиях производства. Это означает не только более комфортабельное вождение, но и лучшую защиту от угрозы здоровью.

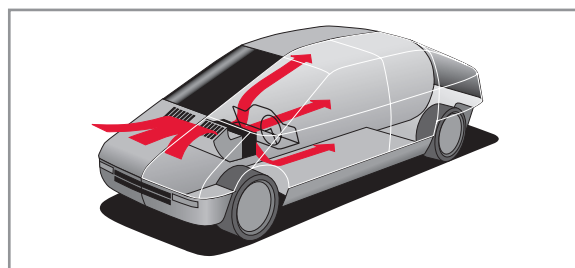

Распределение потоков воздуха в автомобиле

Превосходная технология

DENSO отлично разбирается в системах климат-контроля. Это значит, что наши салонные фильтры обладают улучшенной технологией фильтрации, обеспечивающей более здоровую среду в салоне. Ворсовый материал, который мы используем, содержит до пяти индивидуальных слоев, которые улавливают практически 100% вредных загрязнений и частиц, удерживая их от попадания в салон, где их можно было бы вдохнуть. Фильтры DENSO имеют чрезвычайно точный механизм уплотнения фильтра в корпусе, что повышает эффективность фильтрации. Их эффективная конструкция также защищает систему климат-контроля, принося пользу здоровью каждого пассажира, и, в особенности, людям с аллергией и астмой.



RU

Типы фильтров

Фильтры частиц

Фильтры частиц от DENSO предлагают исключительную защиту от пыли, сажи, пыльцы и частиц. Используя многослойный ворсовый материал для эффективного задержания пыли и твердых веществ, они так же имеют большую удерживающую емкость и минимальное сопротивление потоку воздуха.



Фильтры частиц

Комбинированные фильтры

Комбинированные фильтры DENSO предлагают все блокирующие, электростатические и нанофибровые технологии наших фильтров частиц, улавливая практически 100% пыли, пыльцы и твердых частиц до того, как их, возможно, вдохнут.

Но благодаря дополнительному слою из активированного угля, расположенному внутри фильтрующего материала, наши комбинированные фильтры имеют дополнительное преимущество.

Результат заключается в том, что воздух в салоне всегда свежий, приятный и полезный для дыхания.

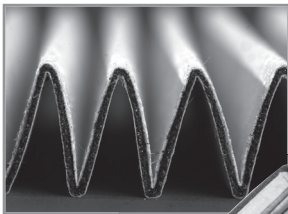

Комбинированные фильтры

Как они работают?

- > **Устранение путем задержания** – частицам не дает пройти в салон плотно сцепленный нетканый фильтрующий слой. Частицы улавливаются и остаются в корпусе фильтра.
- > **Электростатическое устранение** – малые частицы с постоянным или временным зарядами притягиваются и удерживаются из-за электростатического взаимодействия.
- > **Нанофибровые покрытия** – слой тонких волокон вплетен в среду фильтра и предотвращает падение давления.

Замена

Хотя большинство современных новых автомобилей уже имеют салонные фильтры, через некоторое время они засоряются пылью и грязью, которая может содержать бактерии, плесень и микроорганизмы. Это делает фильтр потенциальным источником аллергенов, а также снижает эффективность фильтрации и электростатического заряда. Это может привести к падению давления, что нагружает систему климат-контроля.

Чтобы поддерживать чистую, безопасную атмосферу в салоне, DENSO рекомендует заменять салонный фильтр по меньшей мере один раз в год, каждые 10-15 тысяч километров или как указывает производитель автомобиля. Только регулярная замена гарантирует постоянную эффективность фильтрации и высокую отдачу системы климат-контроля и обеспечивает более гигиеничную и комфортабельную среду в салоне.



Новый фильтр

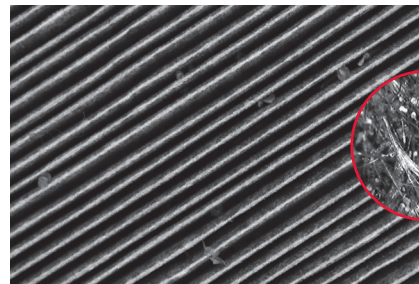





Фильтр после 15.000 км пробега





Смысл замены





- > **Будьте готовы к спросу** – более 80% европейских легковых автомобилей уже оборудованы салонным фильтром, и эта доля растет. Это делает своевременную замену более важной и объемной задачей рынка автозапчастей.
- > **Обучение здоровью** – водители редко бывают осведомлены о важности регулярной замены салонных фильтров или о последствиях поздней замены. Выделите время на то, чтобы обучить своих клиентов. Своевременные действия помогут защитить их собственное здоровье и здоровье пассажиров.
- > **В городе и деревне** – твердые вещества, частицы, вредные газы и неприятные запахи наносят вред как в городе, так и за городом, делая замену салонного фильтра важной в любой среде.





DENSO Application Tables







		LHD  RHD 		Filter Type P	Filter Type K	Pack Quantity
ABARTH						
500 / 595 (C) (312) (07-)			05/08-	DCF499P		1
500 / 595 (C) (312) (07-)			05/08-	DCF580P		1
Grande PUNTO (05-12)			12/07-12/12	DCF488P	DCF201K	1
PUNTO (12-)			03/12-	DCF488P	DCF201K	1
ALFA ROMEO						
147 (00-10)	- AC; + AC		10/00-03/10		DCF048K	
147 (00-10)	- AC; + AC		01/01-03/10		DCF048K	2
155 (92-97)		LHD	09/97-12/97	DCF507P	DCF044K	1
156 (97-06)		LHD	02/97-05/06	DCF507P	DCF044K	1
156 (97-06)		LHD	02/97-05/06		DCF048K	1
156 (97-06)		RHD	02/97-05/06	DCF042P		1
156 (97-06)			03/02-09/05		DCF048K	2
159 (05-11)			06/05-12/12	DCF506P	DCF448K	1
BRERA (06-10)			01/06-05/11	DCF506P	DCF448K	1
GIULIETTA (10-)			04/10-	DCF572P		1
GT (03-10)			11/03-09/10		DCF048K	2
MITO (08-)	- AC; + AC		08/08-	DCF488P	DCF201K	1
MITO (08-)	- AC; + AC		04/16-	DCF488P	DCF201K	
SPIDER (06-10)			03/06-03/11	DCF506P	DCF448K	1
ALPINA						
B3 (E46) (99-06)	+ AC		03/99-01/05	DCF016P		
B3 (F30, F31) (13-19)	+ AC		03/13-06/19	DCF581P		1
B4 (F32, F33) (14-)	+ AC		03/14-08/18	DCF581P		1
D3 (F30, F31) (14-19)	+ AC		07/13-07/18	DCF581P		1
D4 (F32, F33) (14-)	+ AC		09/14-	DCF581P		1
AUDI						
80 (8C, B4) (91-96)	+ AC		09/91-06/93	DCF508P	DCF050K	1
80 (8C, B4) (91-96)	+ AC		09/91-01/96	DCF508P	DCF050K	
A1 (8X) (10-18)	+ AC		05/10-10/18	DCF576P		1
A2 (8Z) (00-05)	+ AC		02/00-08/05	DCF462P	DCF458K	1
A3 (8L) (96-03)	+ AC		09/96-05/03	DCF461P	DCF225K	1
A3 (8P) (03-13)	+ AC	LHD	05/03-08/12	DCF449P	DCF052K	1
A3 (8P) (03-13)	+ AC		09/04-03/13	DCF449P	DCF052K	1
A3 (8V) (12-)	+ AC		04/12-	DCF575P		1
A3 (8V) (12-)	+ AC		05/14-	DCF575P		
A3 Convertible (8P7) (08-13)	+ AC		04/08-05/13	DCF449P	DCF052K	1
A3 Convertible (8V7) (13-)	+ AC		10/13-	DCF575P		1
A3 Convertible (8V7) (13-)	+ AC		07/16-	DCF575P		
A4 (8D, B5) (94-01)	+ AC		11/94-09/01	DCF508P	DCF050K	1
A4 (8D, B5) (94-01)	+ AC		07/95-09/01	DCF508P	DCF050K	
A4 (8E, B6) (00-04)	+ AC		11/00-12/04	DCF463P	DCF054K	1
A4 (8E, B7) (04-08)	+ AC		11/04-06/08	DCF463P	DCF054K	1
A4 (8K, B8) (07-15)	+ AC		11/07-12/15	DCF571P		1
A4 Allroad (8KH) (09-16)	+ AC		04/09-05/16	DCF571P		1
A4 Allroad (8WH) (16-)	+ AC		01/16-	DCF571P		1
A4 Allroad (8WH) (16-)	+ AC		07/18-	DCF571P		
A4 Convertible (8H, B6, B7) (02-09)	+ AC		04/02-03/09	DCF463P	DCF054K	1
A5 (8T, 8F) (07-17)	+ AC		06/07-	DCF571P		1
A6 (4A, C4) (94-97)	+ AC		06/94-07/95		DCF056K	
A6 (4A, C4) (94-97)	+ AC		06/94-12/97		DCF056K	1
A6 (4B, C5) (97-05)	Ch No: >4BX045000, + AC		01/97-01/05		DCF056K	1
A6 (4B, C5) (97-05)	Ch No: 4BX045001>, + AC		01/97-01/05	DCF463P	DCF054K	1
A6 (4B, C5) (97-05)	+ AC		06/01-01/05	DCF463P	DCF054K	
A6 (4B, C5) (97-05)	+ AC		06/01-01/05		DCF056K	
A6 (4F, C6) (04-11)	+ AC		11/04-08/11	DCF522P	DCF122K	2
A6 (4F, C6) (04-11)	+ AC		09/06-10/08	DCF522P	DCF122K	
A6 Allroad (4FH) (06-11)	+ AC		03/06-08/11	DCF522P	DCF122K	2
A8 (4D) (94-02)	+ AC		03/94-09/02	DCF400P		2
A8 (4E) (02-10)	+ AC		10/02-07/10		DCF059K	1
A8 (4E) (02-10)	+ AC		07/03-07/10		DCF059K	
ALLROAD (4BH) (00-05)	+ AC		05/00-08/05	DCF463P	DCF054K	1
CABRIOLET (8G7) (91-00)	+ AC		05/91-08/00	DCF508P	DCF050K	1
COUPE (89, 8B) (88-96)	+ AC		10/88-12/96	DCF508P	DCF050K	1
COUPE (89, 8B) (88-96)	+ AC		11/88-07/91	DCF508P	DCF050K	
Q2 (GAB) (16-)	+ AC		06/16-	DCF575P		1
Q2 (GAB) (16-)	+ AC		09/16-	DCF575P		
Q3 (8U) (11-18)	+ AC	For left-/right-hand drive vehicles	06/11-10/18	DCF449P		1

		LHD  RHD 		Filter Type P	Filter Type K	Pack Quantity
AUDI continued						
Q3 (8U) (11-18)	+ AC	For left-/right-hand drive vehicles	06/11-10/18	DCF449P		1
Q3 (8U) (11-18)	+ AC	LHD	06/11-10/18		DCF052K	1
Q3 (8U) (11-18)	+ AC		09/14-10/18	DCF449P	DCF052K	
Q5 (8R) (08-17)	+ AC		11/08-05/17	DCF571P		1
Q5 (8R) (08-17)	+ AC		09/12-05/16	DCF571P		
Q7 (4L) (06-15)	+ AC		03/06-12/10	DCF477P	DCF234K	
Q7 (4L) (06-15)	+ AC		03/06-08/15	DCF477P	DCF234K	1
R8 (42) (07-15)	+ AC		04/07-07/15	DCF522P		1
R8 (42) (07-15)	+ AC		04/07-07/15		DCF122K	2
TT (8J) (06-14)	+ AC		08/06-06/14	DCF449P	DCF052K	1
TT (8N) (98-06)	+ AC		10/98-06/06	DCF461P	DCF225K	1
TT (FV) (14-)	+ AC		07/14-	DCF575P		1
TT (FV) (14-)	+ AC		07/15-	DCF575P		
BENTLEY						
CONTINENTAL (03-)	Without plastic frame		03/06-		DCF231K	2
CONTINENTAL Flying Spur (05-13)	Without plastic frame		03/05-02/13		DCF231K	2
BMW						
1 (E81, E87) (03-12)	+ AC		06/04-09/12	DCF096P	DCF450K	
1 (F20, F21) (10-)	+ AC		07/11-	DCF581P		1
1 Coupe/Convertible (E82, E88) (07-13)	+ AC		09/07-12/13	DCF096P	DCF450K	
2 Coupe/Convertible (F22, F23) (13-)	+ AC		10/12-	DCF581P		1
3 (E46) (98-06)	+ AC		12/97-12/07	DCF016P	DCF062K	1
3 (E90, E91) (05-12)	+ AC		12/04-12/12	DCF096P	DCF450K	
3 (F30, F31) (11-19)	+ AC		11/11-06/19	DCF581P		1
3 Coupe/Convertible (E92, E93) (06-13)	+ AC		03/06-12/13	DCF096P	DCF450K	
3 Gran Turismo (F34) (13-)	+ AC		11/12-	DCF581P		1
4 Coupe/Convertible (F32, F33) (13-)	+ AC		07/13-	DCF581P		1
4 Gran Coupe (F36) (14-)	+ AC		03/14-	DCF581P		1
5 (E39) (95-04)	+ AC		09/95-05/04	DCF402P	DCF015K	1
5 (E60, E61) (03-10)	+ AC		12/01-12/10	DCF403P	DCF419K	1
6 (E63, E64) (04-10)	+ AC		09/03-08/10	DCF403P	DCF419K	1
7 (E38) (94-01)	+ AC		03/94-11/01	DCF262P		1
7 (E65, E66) (01-08)	+ AC		07/01-08/08	DCF064P	DCF065K	1
X1 (E84) (09-15)	+ AC		03/09-06/15	DCF096P	DCF450K	
X3 (E83) (04-11)	+ AC		09/03-12/11	DCF016P	DCF062K	1
X5 (E53) (00-06)	+ AC		01/00-10/06	DCF475P	DCF340K	1
Z4 (E85, E86) (03-09)	+ AC		12/02-02/09		DCF420K	1
Z4 (E89) (09-16)	+ AC		02/09-08/16		DCF420K	1
CADILLAC						
SRX (09-)			01/09-	DCF564P		
CHEVROLET						
ASTRA (98-11)			09/98-12/11	DCF476P		1
ASTRA (98-11)			09/98-12/11	DCF541P		1
AVEO (T300) (11-)			03/11-	DCF564P		
AVEO / KALOS (T200) (03-08)			05/03-05/08	DCF242P		1
AVEO / KALOS (T250, T255) (05-)			03/05-	DCF242P		1
CAPTIVA (06-)			06/06-	DCF371P		1
CRUZE (09-)			05/09-	DCF564P		
LACETTI (03-)			03/05-	DCF243P		1
LANOS (05-18)			11/05-12/18	DCF075P		1
MALIBU (12-)			01/12-	DCF564P		
MATIZ (05-)			03/05-	DCF245P		1
NUBIRA (05-11)			01/05-12/11	DCF243P		1
ORLANDO (11-)			02/11-	DCF564P		
SPARK (05-)			05/05-	DCF245P		1
SPARK (10-)			01/13-	DCF564P		1
TRAX (12-)			12/12-	DCF564P		
VOLT (11-)			11/11-	DCF564P		
CHRYSLER						
300 C (04-12)			09/04-12/10		DCF080K	1
CROSSFIRE (03-07)			07/03-12/08	DCF009P	DCF068K	1
DELTA (11-)			08/11-	DCF497P		1
SEBRING (01-07)			03/07-06/07		DCF120K	1
SEBRING (06-10)			09/06-12/10		DCF120K	1
VOYAGER I (87-90)			10/87-09/90		DCF067K	1
VOYAGER IV (00-08)		LHD	02/00-12/08		DCF067K	1
VOYAGER IV (00-08)		RHD	02/00-12/08		DCF069K	1





		LHD  RHD 		Filter Type P	Filter Type K	Pack Quantity
CHRYSLER <i>continued</i>						
VOYAGER IV (00-08)		RHD	02/00-12/08		DCF069K	1
VOYAGER V (07-)		LHD	10/07-		DCF067K	1
VOYAGER V (07-)		RHD	10/07-		DCF069K	1
YPSILON (846) (11-)			05/11-	DCF580P		1
CITROËN						
BERLINGO (B9) (08-)	+ Auto CC		04/08-	DCF479P		2
BERLINGO (B9) (08-)	A; Manually controlled		04/08-		DCF073K	1
BERLINGO (MF) (96-11)			07/96-03/08	DCF018P		1
BERLINGO (MF) (96-11)			07/96-03/08	DCF540P		1
BERLINGO (MF) (96-11)	+ Auto CC		01/11-12/11	DCF479P		2
BERLINGO (MF) (96-11)	A; Manually controlled		01/11-12/11		DCF073K	1
C1 I (05-14)	+ AC		06/05-09/14	DCF562P		1
C1 II (14-)			04/14-	DCF585P		1
C2 (03-10)			07/03-09/12	DCF470P	DCF071K	1
C3 I (02-)			02/02-	DCF470P	DCF071K	1
C3 II (09-)			09/09-	DCF470P	DCF071K	1
C3 III (16-)			07/16-	DCF560P		2
C3 Picasso (09-)			02/09-	DCF470P	DCF071K	1
C3 Pluriel (03-)			05/03-	DCF470P	DCF071K	1
C4 (Grand) Picasso I (06-13)			10/06-12/13		DCF073K	1
C4 (Grand) Picasso I (06-13)			10/06-12/13	DCF479P		2
C4 (Grand) Picasso II (13-)			02/13-	DCF479P	DCF073K	2
C4 (Grand) Picasso II (13-)			09/13-		DCF073K	1
C4 Aircross (12-)			04/12-	DCF467P		1
C4 Cactus (14-)			09/14-	DCF560P		2
C4 Coupe (04-11)			11/04-07/11	DCF470P	DCF071K	1
C4 I (LC, LR) (04-11)			11/04-07/11	DCF470P	DCF071K	1
C4 II (B7, NC) (09-)			11/09-	DCF470P	DCF071K	1
C5 I (01-04)			03/01-08/04	DCF405P	DCF346K	1
C5 II (04-)			09/04-		DCF211K	1
C5 III (08-)			02/08-		DCF211K	1
C6 (05-14)			09/05-12/12		DCF211K	1
C8 (02-)			07/02-	DCF532P	DCF072K	1
C-CROSSER (07-)			02/07-	DCF467P	DCF344K	1
DS3 (09-15)			11/09-07/15	DCF560P		2
DS4 (11-15)			04/11-07/15	DCF470P	DCF071K	1
DS5 (11-15)			11/11-07/15		DCF073K	1
DS5 (11-15)			11/11-07/15	DCF479P		2
JUMPER (94-02)			02/94-04/02	DCF536P		1
JUMPER (02-)			02/02-	DCF536P		1
JUMPER (06-)			04/06-	DCF454P		1
JUMPER (06-)			04/06-	DCF536P		1
JUMPY (95-06)			04/04-10/06	DCF532P		1
JUMPY (06-)	+ AC		01/07-		DCF332K	1
JUMPY (16-)			04/16-		DCF073K	1
JUMPY (16-)			04/16-	DCF479P		2
JUMPY (16-)	+ AC		04/16-		DCF332K	1
NEMO (08-)			02/08-	DCF485P		1
NEMO (08-)		LHD	10/15-	DCF485P	DCF201K	1
NEMO (08-)		RHD	10/15-	DCF488P		1
NEMO (08-)	+ AC	LHD	02/16-	DCF485P	DCF201K	1
NEMO (08-)	+ AC	RHD	02/16-	DCF488P		1
SPACETOURER (16-)			04/16-		DCF073K	1
SPACETOURER (16-)			04/16-	DCF479P		2
XANTIA (93-03)			03/93-04/03	DCF018P		1
XSARA (97-05)	+ AC (Auto)		04/97-08/05	DCF018P		1
XSARA (97-05)	A; Manually controlled		04/97-08/05	DCF540P		1
XSARA Picasso (99-11)			12/99-06/12	DCF513P		1
ZX (91-98)			03/91-02/98	DCF018P		1
DACIA						
LOGAN I (04-)	+ AC		09/04-	DCF502P		1
LOGAN II (12-)	+ AC		10/12-	DCF579P		1
LOGAN MCV I (07-)	+ AC		02/07-	DCF502P		1
LOGAN MCV II (13-)	+ AC		02/13-	DCF579P		1
SANDERO II (Stepway) (12-)	+ AC		10/12-	DCF579P		1
DAEWOO						
KALOS (02-)			09/02-	DCF242P		1
LACETTI (99-03)			06/99-07/03	DCF243P		1





		LHD  RHD 		Filter Type P	Filter Type K	Pack Quantity
DAEWOO continued						
LACETTI (99-03)			06/99-07/03	DCF243P		1
LACETTI (04-)			06/02-	DCF243P		1
LANOS (97-)			10/02-	DCF075P		1
LEGANZA (97-04)		LHD	06/97-04/04	DCF076P		1
LEGANZA (97-04)		RHD	06/97-04/04	DCF078P		1
MATIZ (98-04)			09/98-12/04	DCF245P		1
MATIZ (05-12)			01/05-06/10	DCF245P		1
NUBIRA (97-)		LHD	05/97-07/03	DCF075P		1
NUBIRA (97-)			07/03-	DCF243P		1
NUBIRA (03-)			07/03-	DCF243P		1
DAIHATSU						
CHARADE VI (11-)			05/11-	DCF382P		1
CUORE VII (06-)			04/07-	DCF466P		1
TERIOS (97-05)			10/97-10/06	DCF466P		1
TERIOS (05-)			11/05-	DCF466P		1
DODGE						
CALIBER (06-)			06/06-		DCF120K	1
JOURNEY (08-)			06/08-		DCF120K	1
DS						
DS3 (15-19)			04/15-07/19	DCF560P		2
DS4 (Crossback) (15-18)			07/15-12/18		DCF073K	1
DS4 (Crossback) (15-18)			07/15-12/18	DCF479P		2
DS5 (15-18)			04/15-12/18		DCF073K	1
DS5 (15-18)			04/15-12/18	DCF479P		2
FERRARI						
612 SCAGLIETTI (04-11)			04/04-06/11		DCF135K	1
FIAT						
500 (C) (312) (07-)			07/07-	DCF499P		1
500 (C) (312) (07-)			07/07-	DCF580P		1
500 A/B/C (36-55)			03/49-12/55	DCF488P	DCF201K	1
500L (12-)			09/12-	DCF584P		1
500X (14-)			09/14-	DCF584P		1
ALBEA / SIENA (96-11)			04/96-07/98	DCF086P		1
BRAVA (95-02)		LHD	10/95-12/02	DCF507P	DCF044K	1
BRAVA (95-02)		RHD	10/95-12/02	DCF042P		1
BRAVO I (95-01)		LHD	10/95-10/01	DCF507P	DCF044K	1
BRAVO I (95-01)		RHD	10/95-10/01	DCF042P		1
BRAVO II (06-14)			11/06-12/14	DCF497P		1
CROMA (05-)			06/05-	DCF481P	DCF223K	1
DOBLO (01-)			03/01-	DCF504P	DCF090K	1
DOBLO (10-)			01/10-	DCF485P		1
DUCATO (230) (94-02)			03/94-04/02	DCF536P		1
DUCATO (244) (02-)			04/02-07/06	DCF536P		1
DUCATO (250, 290) (06-)			07/06-	DCF454P		1
FIORINO (07-)			11/07-	DCF485P	DCF201K	1
FIORINO (07-)	+ AC	LHD	10/09-	DCF485P		1
FIORINO (07-)	+ AC	RHD	10/09-	DCF488P	DCF201K	1
FREEMONT (11-)			08/11-		DCF120K	1
FULLBACK (16-)			04/16-	DCF467P		1
Grande PUNTO (05-)			06/05-	DCF488P	DCF201K	1
IDEA (03-)			12/03-	DCF504P	DCF090K	1
LINEA (07-)			05/07-	DCF485P		1
MAREA (96-07)			05/96-06/03		DCF044K	1
MAREA (96-07)		LHD	05/96-06/03	DCF507P		1
MAREA (96-07)		RHD	05/96-06/03	DCF042P		1
MULTIPLA (99-10)			04/99-06/10	DCF083P		1
PALIO (96-)			04/96-05/99	DCF086P		1
PANDA (03-)			09/03-	DCF499P		1
PANDA (12-)			02/12-	DCF580P		1
PUNTO (99-12)			09/99-03/12	DCF504P	DCF090K	1
PUNTO (12-)			03/12-	DCF488P	DCF201K	1
PUNTO Evo (08-12)			07/08-02/12	DCF488P	DCF201K	1
QUBO (08-)			02/08-	DCF485P		1
QUBO (08-)	+ AC	LHD	10/09-	DCF485P		1
QUBO (08-)	+ AC	RHD	10/09-	DCF488P	DCF201K	1
SCUDO (220) (96-06)			09/96-12/06	DCF532P	DCF072K	1
SCUDO (270) (07-)			01/07-		DCF332K	1
SEDICI (06-14)			06/06-10/14	DCF466P		1

		LHD  RHD 		Filter Type P	Filter Type K	Pack Quantity
FIAT continued						
SEDICI (06-14)			06/06-10/14	DCF466P		1
STILO (01-08)			10/01-08/08	DCF497P		1
TALENTO (296) (16-)			06/16-	DCF586P		1
TIPO (356) (15-)			10/15-	DCF485P		1
ULYSSE (02-11)			08/02-06/11	DCF532P	DCF072K	1
FORD						
B-MAX (12-)	+ AC		10/12-	DCF489P	DCF365K	1
C-MAX I (07-10)	+ AC		02/07-09/10	DCF471P	DCF106K	1
C-MAX II (10-)	+ AC		04/10-	DCF471P	DCF106K	1
COUGAR (98-01)	+ AC	For left-/right-hand drive vehicles	08/98-09/00	DCF523P		1
ECOSPORT (12-)	+ AC		08/12-	DCF489P	DCF365K	1
FIESTA V (01-08)	+ AC		11/01-12/10	DCF478P	DCF105K	1
FIESTA VI (08-)	+ AC		06/08-	DCF489P	DCF365K	1
FIESTA VII (17-)	+ AC		05/17-	DCF489P		1
FOCUS C-MAX (03-07)	+ AC		10/03-03/07	DCF471P	DCF106K	1
FOCUS I (98-05)	+ AC		10/98-03/05	DCF474P		1
FOCUS II (04-12)	+ AC		07/04-09/12	DCF465P	DCF236K	1
FOCUS III (10-)	+ AC		07/10-	DCF471P		1
FUSION (02-12)	+ AC		08/02-12/12	DCF478P	DCF105K	1
GALAXY I (95-06)	+ AC		03/95-05/06	DCF500P	DCF094K	1
GALAXY II (06-15)	+ AC		05/06-06/15	DCF471P	DCF106K	1
Grand C-MAX (10-)	+ AC		12/10-	DCF471P		1
KA (08-16)	+ AC		10/08-05/16	DCF499P		1
KA+ (16-)	+ AC		06/16-	DCF489P	DCF365K	1
KUGA I (08-12)	+ AC		02/08-11/12	DCF471P	DCF106K	1
KUGA II (12-)	+ AC		10/12-	DCF471P		1
MAVERICK (93-98)	+ AC		02/93-04/98	DCF190P		1
MONDEO I (93-96)	+ AC	For left-/right-hand drive vehicles	01/93-08/96	DCF523P		1
MONDEO II (96-00)	+ AC	For left-/right-hand drive vehicles	08/96-09/00	DCF523P		1
MONDEO III (00-07)	+ AC		10/00-03/07	DCF517P		1
MONDEO IV (07-15)	+ AC		03/07-01/15	DCF471P	DCF106K	1
S-MAX (06-14)	+ AC		05/06-12/14	DCF471P	DCF106K	1
TOURNEO Connect (02-13)	+ AC		06/02-12/13	DCF474P		1
TOURNEO Connect (13-)	+ AC		09/13-	DCF471P		1
TOURNEO Courier (14-)	+ AC		02/14-	DCF489P	DCF365K	1
TRANSIT (06-14)	+ AC		04/06-12/14	DCF589P		1
TRANSIT Connect (02-13)	+ AC		06/02-12/13	DCF474P		1
TRANSIT Connect (13-)	+ AC		02/13-	DCF471P		1
TRANSIT Courier (14-)	+ AC		02/14-	DCF489P	DCF365K	1
TRANSIT Tourneo (06-14)	+ AC		07/06-08/14	DCF589P		1
HONDA						
ACCORD VI (97-05)			03/97-06/03	DCF255P		1
ACCORD VII (03-08)			09/02-05/08	DCF473P		1
ACCORD VIII (08-)			06/08-	DCF561P		1
CITY (08-)			09/08-	DCF573P		1
CIVIC IX (11-)			02/12-	DCF561P		1
CIVIC V (91-97)	A; Manually controlled		08/93-03/96	DCF109P		1
CIVIC VI (94-01)	A; Manually controlled		09/94-02/01	DCF109P		1
CIVIC VI (94-01)			10/95-02/01	DCF109P		1
CIVIC VI (94-01)	- AC		04/98-02/01	DCF109P		1
CIVIC VII (00-05)			12/00-12/05	DCF512P		2
CIVIC VIII Hatchback (05-)			09/05-	DCF473P		1
CIVIC VIII Saloon (05-)			09/05-	DCF473P		1
CIVIC VIII Saloon (05-)			09/05-	DCF561P		1
CR-V I (95-02)	A; Manually controlled		10/95-02/02	DCF109P		1
CR-V II (01-06)			09/01-03/07	DCF512P		2
CR-V III (06-)			09/06-	DCF561P		1
CR-V IV (12-)			01/12-	DCF561P		1
CR-Z (10-)			06/10-	DCF573P		1
FR-V (04-)			08/04-	DCF512P		2
HR-V (14-)			08/15-	DCF573P		1
INSIGHT (09-)			04/09-	DCF573P		1
JAZZ II (02-08)			03/02-10/08	DCF466P		1
JAZZ III (08-)			10/07-	DCF573P		1

Cabin Air Filter





Application Tables





		LHD  RHD 		Filter Type P	Filter Type K	Pack Quantity
HONDA continued						
JAZZ III (08-)			10/07-	DCF573P		1
JAZZ IV (13-)			09/13-	DCF573P		1
JAZZ Saloon (03-08)			12/02-07/08	DCF466P		1
LEGEND III (96-06)			02/96-10/97	DCF473P		1
LEGEND IV (06-12)			05/06-12/12	DCF473P		1
PILOT (08-)			09/08-	DCF561P		1
STREAM (01-06)			05/01-09/06	DCF512P		2
HYUNDAI						
ACCENT I (94-00)	+ AC (Auto)		10/94-01/00	DCF408P		1
ACCENT I (94-00)	A; Manually controlled		10/94-01/00	DCF210P		1
ACCENT II (99-06)	+ AC (Auto)		09/99-11/05	DCF408P		1
ACCENT II (99-06)	A; Manually controlled		09/99-11/05	DCF210P		1
ACCENT III (05-10)			11/05-11/10	DCF263P		1
ACCENT IV / SOLARIS (10-)			11/10-	DCF486P		1
COUPE (96-02)			08/96-04/02	DCF366P		1
COUPE (01-09)			01/01-08/09	DCF366P		1
CRETA (16-)			01/16-	DCF577P		1
ELANTRA (00-06)			06/00-07/06	DCF366P		1
ELANTRA (05-11)			12/07-12/11	DCF577P		1
ELANTRA (10-)			02/11-04/16	DCF577P		1
GENESIS (08-14)			01/08-12/14	DCF486P		1
GENESIS Coupe (08-)			01/08-	DCF486P		1
GETZ (02-09)			09/02-12/10	DCF266P		2
Grand SANTA FÉ III (13-)			06/13-	DCF481P		1
GRANDEUR / XG (98-05)			12/98-12/05	DCF410P		1
HIGHWAY VAN (00-04)			03/01-03/04	DCF410P		1
i10 I (07-13)			12/07-12/17	DCF284P		1
i10 II (13-)			08/13-	DCF284P		1
i20 I (08-15)			08/08-12/15	DCF570P		1
i20 II (14-)			11/14-	DCF263P		1
i20 II (14-)			11/14-	DCF577P		1
i30 (07-12)			10/07-06/12	DCF483P		1
i30 (11-)			11/11-	DCF577P		1
i30 (16-)			11/16-	DCF577P		1
i30 Coupe (13-)			05/13-	DCF577P		1
i40 (11-)			07/11-	DCF486P		1
IONIQ (16-)			03/16-	DCF582P		1
ix20 (10-)			11/10-	DCF569P		1
ix35 (09-)			08/09-	DCF486P		1
ix35 (09-)			08/09-	DCF582P		1
MATRIX (01-10)			06/01-08/10	DCF366P		1
SANTA FÉ I (00-06)			11/00-03/06	DCF410P		1
SONATA IV (98-05)			03/98-05/05	DCF268P		2
TRAJET (00-08)			03/00-07/08	DCF410P		1
TUCSON (04-10)			08/04-	DCF486P		1
TUCSON (15-)			06/15-	DCF582P		1
VELOSTER (11-17)			03/11-12/17	DCF486P		1
INFINITI						
FX (02-08)			01/03-12/08		DCF273K	1
FX (08-)			10/08-		DCF273K	1
G (02-07)			09/02-	DCF467P		1
ISUZU						
D-MAX II (12-)			06/12-	DCF467P	DCF344K	1
IVECO						
DAILY III (97-06)			05/99-07/07	DCF507P	DCF044K	1
DAILY IV (06-11)			05/06-08/11	DCF368P		1
DAILY V (11-14)			09/11-02/14	DCF368P		1
DAILY VI (14-)			03/14-	DCF368P		1
MASSIF (08-11)			10/08-02/11	DCF368P		1
JAGUAR						
F-TYPE (12-)			10/12-		DCF119K	1
S-TYPE (99-08)			01/99-10/07		DCF118K	1
XK (06-14)			03/06-07/14		DCF119K	1
X-TYPE (01-09)			06/01-12/09	DCF517P		1
JEEP						
COMPASS (06-)			08/06-		DCF120K	1
PATRIOT (07-17)			02/07-12/17		DCF120K	1
RENEGADE (14-)			07/14-	DCF584P		1

		LHD  RHD 		Filter Type P	Filter Type K	Pack Quantity
KIA						
RENEGADE (14-)			07/14-	DCF584P		1
CARENS II (02-)			07/02-08/05	DCF279P		2
CARENS II (02-)			09/05-08/06	DCF486P		1
CARENS III (06-)			09/06-	DCF486P		1
CARENS IV (13-)			03/13-	DCF577P		1
CARNIVAL I (99-01)			08/99-10/01	DCF280P		1
CARNIVAL II (99-07)			08/99-09/07	DCF280P		1
CEED (06-12)			12/06-12/12	DCF483P		1
CEED (12-)			05/12-	DCF577P		1
CERATO (09-)			01/09-	DCF486P		1
CLARUS (96-)			07/96-	DCF283P		2
MAGENTIS (01-)			05/01-	DCF410P		1
NIRO (16-)			09/16-	DCF582P		1
PICANTO (04-)			04/04-	DCF284P		1
PICANTO (11-)			05/11-	DCF284P		1
PRO CEED (08-13)			02/08-02/13	DCF483P		1
PRO CEED (13-)			03/13-	DCF577P		1
RIO I (00-05)			08/00-02/05	DCF283P		2
RIO II (05-)			03/05-	DCF486P		1
RIO III (11-)			06/11-	DCF486P		1
SHUMA I (96-01)			03/96-12/01	DCF285P		2
SHUMA II (01-04)			05/01-08/04	DCF285P		2
SORENTO I (02-)			08/02-10/09	DCF410P		1
SPORTAGE I (94-04)			04/94-08/03	DCF486P		1
SPORTAGE II (04-10)			09/04-	DCF486P		1
SPORTAGE III (10-)			06/10-	DCF582P		1
SPORTAGE IV (15-)			09/15-	DCF582P		1
VENGA (10-)			02/10-	DCF569P		1
LADA						
VESTA (15-)	+ AC		11/15-	DCF579P		1
X-RAY (16-)	+ AC		01/16-	DCF579P		1
XRAY (16-)	+ AC		02/16-	DCF579P		1
LAMBORGHINI						
GALLARDO (03-)			08/03-		DCF122K	2
LANCIA						
DELTA III (08-14)			08/08-08/14	DCF497P		1
FLAVIA (12-14)			03/12-12/14		DCF120K	1
LYBRA (99-05)			07/99-10/05	DCF507P	DCF044K	1
MUSA (04-12)			10/04-09/12	DCF504P	DCF090K	1
PHEDRA (02-10)			09/02-11/10	DCF532P	DCF072K	1
THESIS (02-09)			07/02-07/09		DCF125K	1
YPSILON (312/846) (11-)			05/11-	DCF580P		1
YPSILON (843) (03-11)			10/03-12/11	DCF504P	DCF090K	1
LAND ROVER						
DISCOVERY III (04-09)			07/04-12/09	DCF516P	DCF127K	1
DISCOVERY IV (09-18)			09/09-12/18	DCF516P	DCF127K	1
FREELANDER I (98-06)			02/98-10/06	DCF411P		1
RANGE ROVER II (94-02)			07/94-03/02	DCF286P		2
RANGE ROVER III (02-12)			03/02-08/12	DCF475P	DCF340K	1
RANGE ROVER Sport (05-13)			02/05-03/13	DCF516P	DCF127K	1
LEXUS						
CT (10-)			12/10-	DCF382P		1
ES (12-18)			06/12-06/18	DCF382P		1
ES (12-18)		For left-/right-hand drive vehicles	08/15-06/18	DCF386P	DCF387K	1
GS (05-11)			04/05-11/11	DCF382P		1
GS (12-)			12/11-	DCF382P	DCF389K	1
GX (01-09)			11/01-11/09	DCF353P		1
GX (09-)			01/10-	DCF382P		1
IS C (09-15)			04/09-06/15	DCF382P		1
IS I (99-05)			04/99-10/05	DCF354P		1
IS II (05-13)			08/05-03/13	DCF382P		1
IS III (13-)			04/13-		DCF389K	1
LFA (10-12)			12/10-11/12	DCF382P		1
LS (94-00)			12/94-12/00	DCF354P		1
LS (06-17)			04/06-	DCF382P		1
LX (07-)			11/07-	DCF382P		1
NX (14-)			07/14-	DCF382P		1

Cabin Air Filter





Application Tables





		LHD  RHD 		Filter Type P	Filter Type K	Pack Quantity
LEXUS continued						
NX (14-)			07/14-	DCF382P		1
RC (14-)			08/14-		DCF389K	1
RX (98-03)			01/98-05/03	DCF354P		1
RX (03-08)			04/03-12/08	DCF382P	DCF384K	1
RX (03-08)			05/03-12/08		DCF384K	1
RX (08-15)			12/08-10/15	DCF382P	DCF384K	1
UX (18-)		For left-/right-hand drive vehicles	10/18-	DCF386P	DCF387K	1
MASERATI						
QUATTROPORTE V (04-)			03/04-		DCF135K	1
MAYBACH						
57 (02-12)			09/02-12/12	DCF514P		1
MAZDA						
2 (03-07)			02/03-06/07	DCF480P		1
3 (00-09)			10/03-12/09	DCF563P		2
3 (09-14)			12/08-09/14	DCF563P		2
3 (13-)			07/13-	DCF578P		1
5 (05-10)			02/05-05/10	DCF563P		2
5 (10-)			06/10-	DCF563P		2
6 (02-07)			01/02-02/08	DCF480P		1
6 (07-13)			08/07-07/13	DCF480P		1
6 (12-)			08/12-	DCF578P		1
323 F VI (98-04)			09/98-05/04		DCF457K	2
323 F VI (98-04)	- AC		09/98-05/04	DCF295P		1
323 S VI (98-04)			09/98-05/04		DCF457K	1
323 S VI (98-04)	- AC		09/98-05/04	DCF295P		1
626 V (97-02)			05/97-10/02		DCF457K	2
626 V (97-02)	- AC		05/97-10/02	DCF295P		1
CX-5 (17-)			05/17-	DCF578P		1
CX-5 (11-17)			11/11-02/17	DCF578P		1
CX-7 (07-14)			06/06-12/14	DCF480P		1
PREMACY (99-05)			07/99-03/05		DCF457K	2
PREMACY (99-05)	- AC		07/99-03/05	DCF295P		1
MERCEDES-BENZ						
A-CLASS (W168) (97-04)			07/97-08/04	DCF495P	DCF035K	1
A-CLASS (W169) (04-12)			09/04-06/12	DCF452P	DCF453K	1
B-CLASS (W245) (05-11)			03/05-11/11	DCF452P	DCF453K	1
C-CLASS (202) (93-01)		LHD	03/93-03/01	DCF009P	DCF068K	1
C-CLASS (203) (00-07)		LHD	05/00-08/07		DCF152K	1
C-CLASS (203) (00-07)		RHD	05/00-08/07		DCF153K	1
C-CLASS (203) (00-07)	+ Auto CC		05/00-08/07		DCF161K	2
C-CLASS (205) (13-)	Pre Filter		12/13-	DCF587P		1
C-CLASS Coupe (C204) (11-)	Pre Filter		06/11-	DCF587P		1
C-CLASS Coupe (CL203) (01-08)		LHD	03/01-05/08		DCF152K	1
C-CLASS Coupe (CL203) (01-08)		RHD	03/01-05/08		DCF153K	1
C-CLASS Coupe (CL203) (01-08)	+ Auto CC		03/01-05/08		DCF161K	2
C-CLASS Coupe / Convertible (205) (16-)	Pre Filter		10/15-	DCF587P		1
CITAN (415) (12-)			11/12-	DCF568P		2
CLC (CL203) (08-11)		LHD	05/08-06/11		DCF152K	1
CLC (CL203) (08-11)		RHD	05/08-06/11		DCF153K	1
CLC (CL203) (08-11)	+ Auto CC		05/08-06/11		DCF161K	2
CLK (208) (97-02)			06/97-06/02	DCF009P	DCF068K	1
CLK (209) (02-10)			06/02-03/10		DCF152K	1
CLK (209) (02-10)	+ Auto CC		06/02-03/10		DCF161K	2
CLS (219) (04-10)			10/04-12/10		DCF252K	1
E-CLASS (124) (92-96)			06/93-06/96	DCF159P	DCF068K	2
E-CLASS (210) (95-03)	+ AC (Auto)		06/95-03/03	DCF514P		1
E-CLASS (210) (95-03)	A; Manually controlled		06/95-03/03	DCF009P	DCF068K	1
E-CLASS (211) (02-09)	Ch No: >A635991 / X170336, + Auto CC		03/02-06/04	DCF144P		1
E-CLASS (211) (02-09)	Ch No: >A635991 / X170336, + Auto CC		03/02-06/04		DCF162K	2
E-CLASS (211) (02-09)	A; Manually controlled		03/02-12/08	DCF145P	DCF252K	1
E-CLASS (211) (02-09)	A; Manually controlled	LHD	03/03-07/09	DCF144P	DCF252K	1
E-CLASS (211) (02-09)	A; Manually controlled	RHD	03/03-07/09	DCF145P		1
E-CLASS (211) (02-09)	Ch No: A635992 / X170336>, + Auto CC		07/04-12/08		DCF252K	1
E-CLASS (213) (16-)	Pre Filter		01/16-	DCF587P		1
E-CLASS Coupe / Convertible (124) (93-98)			06/93-03/98	DCF159P		2





		LHD  RHD 		Filter Type P	Filter Type K	Pack Quantity
MERCEDES-BENZ continued						
E-CLASS Coupe / Convertible (124) (93-98)			06/93-03/98	DCF159P		2
G-CLASS (W461) (90-)			01/03-	DCF462P	DCF458K	1
G-CLASS (W463) (89-)			09/89-	DCF462P	DCF458K	1
GL (X164) (06-12)			09/06-12/12		DCF163K	2
GL (X166) (12-15)	Pre Filter		07/12-10/15	DCF587P		1
GLC (253) (15-)	Pre Filter		06/15-	DCF587P		1
GLE (W166) (15-18)	Pre Filter		04/15-10/18	DCF587P		1
GLE Coupe (C292) (15-19)	Pre Filter		03/15-10/19	DCF587P		1
GLS (X166) (15-19)	Pre Filter		11/15-04/19	DCF587P		1
KOMBI (S124) (85-93)			09/85-07/93	DCF159P		1
M-CLASS (W163) (98-05)			02/98-06/05	DCF412P	DCF341K	1
M-CLASS (W164) (05-11)			02/05-12/11		DCF163K	2
M-CLASS (W166) (11-15)	Pre Filter		06/11-12/15	DCF587P		1
R-CLASS (251) (06-14)			08/05-12/14		DCF163K	2
Saloon (W124) (84-93)			12/84-08/93	DCF159P		1
S-CLASS (W140) (91-98)	+ AC	LHD	02/91-10/98	DCF141P	DCF164K	1
S-CLASS (W140) (91-98)	+ AC	RHD	02/91-10/98	DCF142P		1
S-CLASS (W220) (98-05)	+ AC		10/98-08/05	DCF514P		2
S-CLASS (W221) (05-13)			10/05-12/13		DCF168K	2
S-CLASS Coupe (C140) (92-99)	+ AC	LHD	09/92-12/99	DCF141P	DCF164K	1
S-CLASS Coupe (C140) (92-99)	+ AC	RHD	09/92-12/99	DCF142P		1
S-CLASS Coupe (C215) (99-06)			03/99-03/06	DCF514P		2
S-CLASS Coupe (C216) (06-13)			05/06-12/13		DCF168K	2
SL (R230) (01-12)			10/01-01/12		DCF160K	2
SLC (R172) (16-)			01/16-		DCF170K	1
SLK (R170) (96-04)	With automatic climate control, - AC		09/96-04/04	DCF009P	DCF068K	1
SLK (R171) (04-11)			03/04-02/11		DCF170K	1
SLK (R172) (11-)			02/11-		DCF170K	1
SLR (R199) (04-)			04/04-		DCF160K	2
SPRINTER 2-t (901, 902) (95-06)			01/95-05/06	DCF537P		1
SPRINTER 3,5-t (906) (06-)			06/06-	DCF511P	DCF081K	1
SPRINTER 3-t (903) (95-06)			02/95-05/06	DCF537P		1
SPRINTER 3-t (906) (06-)			06/06-	DCF511P	DCF081K	1
SPRINTER 4,6-t (906) (06-)			06/06-	DCF511P	DCF081K	1
SPRINTER 4-t (904) (96-06)			02/95-05/06	DCF537P		1
SPRINTER 5-t (905) (01-)			04/01-	DCF537P		1
SPRINTER 5-t (906) (06-)			06/06-	DCF511P	DCF081K	1
SPRINTER Classic (909) (13-)			09/13-		DCF081K	1
VANEO (414) (02-05)			02/02-07/05	DCF495P	DCF035K	1
VIANO (W639) (03-)			09/03-	DCF521P	DCF172K	1
VITO / MIXTO (W639) (03-)			09/03-	DCF521P	DCF172K	1
MG						
MG ZR (01-05)	- AC		06/01-04/05	DCF109P		1
MG ZS (01-05)	- AC		07/01-10/05	DCF109P		1
MINI						
MINI (R50, R53) (01-06)			06/01-09/06	DCF061P	DCF063K	1
MINI (R56) (06-13)			09/06-11/13	DCF567P		1
MINI Clubman (R55) (07-14)			08/07-06/14	DCF567P		1
MINI Convertible (R52) (04-07)			04/04-07/08	DCF061P	DCF063K	1
MINI Convertible (R57) (07-15)			10/07-06/15	DCF567P		1
MINI Countryman (R60) (10-16)			08/10-10/16	DCF567P		1
MINI Coupe (R58) (10-15)			12/10-05/15	DCF567P		1
MINI Paceman (R61) (12-16)			03/12-10/16	DCF567P		1
MINI Roadster (R59) (11-15)			11/11-04/15	DCF567P		1
MITSUBISHI						
ASX (10-)			02/10-	DCF467P	DCF344K	1
CARISMA (95-06)	- AC		07/95-06/06	DCF302P		1
CARISMA (95-06)	+ AC		07/95-06/06	DCF303P		2
COLT CZC (06-09)			05/06-07/09	DCF305P	DCF181K	1
COLT V (95-03)			05/96-09/03	DCF303P		2
COLT VI (04-12)			06/04-06/12	DCF305P	DCF181K	1
GALANT VI (96-04)			09/96-10/04	DCF306P		1
GRANDIS (04-11)	+ AC		04/04-12/11		DCF300K	1
L 200 / TRITON (05-15)			11/05-12/15	DCF303P		2
L 200 / TRITON (14-)			11/14-	DCF467P		1
L 200 (86-96)			11/86-10/96	DCF303P		2
L 200 (96-07)			06/96-03/03	DCF303P		2





Cabin Air Filter





Application Tables





		LHD  RHD 		Filter Type P	Filter Type K	Pack Quantity
MITSUBISHI continued						
L 200 (96-07)			06/96-03/03	DCF303P		2
LANCER Evo IX (05-07)			01/05-09/07		DCF300K	1
LANCER Evo IX (05-07)			01/05-09/07	DCF303P		2
LANCER Evo V (98)			01/98-12/98	DCF303P		2
LANCER Evo VIII (03-05)			03/04-07/05		DCF300K	1
LANCER Evo VIII (03-05)			03/04-07/05	DCF303P		2
LANCER Evo X (07-15)			03/08-12/15	DCF467P	DCF344K	1
LANCER VI (95-03)			09/95-09/99	DCF303P		2
LANCER VII (03-13)			09/03-10/08		DCF300K	1
LANCER VII (03-13)			09/03-10/08	DCF303P		2
LANCER VIII (07-)			01/08-	DCF467P	DCF344K	1
OUTLANDER I (03-06)			03/01-09/07		DCF300K	1
OUTLANDER II (06-12)			11/06-11/12	DCF467P	DCF344K	1
OUTLANDER III (12-)			08/12-	DCF467P	DCF344K	1
PAJERO Classic (02-)			07/01-		DCF053K	1
PAJERO Classic (02-)		LHD	07/01-		DCF336K	1
PAJERO II (90-00)			12/90-04/00		DCF053K	1
PAJERO II (90-00)		LHD	12/90-04/00		DCF336K	1
PAJERO III (00-07)		LHD	04/00-01/07		DCF053K	1
PAJERO III (00-07)		RHD	04/00-01/07		DCF336K	1
PAJERO IV (06-)			10/06-		DCF053K	1
PAJERO IV (06-)		LHD	10/06-		DCF336K	1
PAJERO Pinin (99-07)			10/99-06/07	DCF423P		2
PAJERO Sport I (97-)			11/97-		DCF053K	1
PAJERO Sport I (97-)		LHD	11/97-		DCF336K	1
PAJERO Sport I (97-)			12/99-01/08	DCF303P		2
PAJERO Sport II (08-)			07/08-		DCF300K	1
SPACE RUNNER (91-99)			10/91-08/99	DCF309P		1
SPACE RUNNER (99-02)			08/99-01/03	DCF309P		1
SPACE STAR / MIRAGE (12-)			01/12-	DCF303P		1
SPACE STAR (98-04)	- AC		06/98-12/04	DCF302P		1
SPACE STAR (98-04)	+ AC		06/98-12/04	DCF303P		2
SPACE WAGON (98-04)			10/98-12/04	DCF309P		1
NISSAN						
ALMERA Classic (06-)	+ AC		03/06-		DCF273K	1
ALMERA II (00-06)	+ AC		01/00-11/06		DCF273K	1
ALMERA TINO (00-06)	+ AC		08/00-02/06		DCF273K	1
INTERSTAR (02-)	+ AC		08/03-	DCF418P		1
JUKE (10-)	+ AC, UK		06/10-	DCF565P		1
KUBISTAR (03-)	+ AC		08/03-	DCF502P		1
MAXIMA IV (95-00)	+ AC		01/95-12/00		DCF188K	2
MAXIMA V (99-03)	+ AC		03/00-11/03		DCF188K	2
MICRA IV (K13) (10-)	+ AC		05/10-	DCF574P		1
MICRA V (K14) (16-)	+ AC		12/16-	DCF579P		1
MURANO I (03-08)	+ AC		08/03-09/08		DCF273K	1
NOTE (E12) (13-)	+ AC		06/13-	DCF574P		1
NV300 (X82) (16-)	+ AC		09/16-	DCF586P		1
NV400 (X62) (11-)	+ AC		11/11-	DCF568P		2
PATROL GR II (97-)	+ AC		06/97-	DCF187P		1
PIXO (09-)	+ AC		03/09-	DCF376P		1
PRIMASTAR (01-)	+ AC		07/02-	DCF418P		1
PRIMERA (P10) (90-98)	+ AC		06/90-03/98	DCF190P		1
PRIMERA (P11) (96-02)	+ AC		06/96-07/02	DCF190P		1
PRIMERA (P12) (02-)	+ AC		01/02-		DCF273K	1
PULSAR (C13) (12-)	+ AC, UK		10/14-	DCF565P		1
QASHQAI I (+2) (07-13)	+ AC		02/07-12/13	DCF509P	DCF370K	1
QASHQAI II (13-)	+ AC		11/13-	DCF588P		1
SENTRA VII (12-)	+ AC, UK		08/12-	DCF565P		1
TEANA I (03-08)	+ AC		10/03-06/08	DCF467P		1
TERRANO II (92-07)	+ AC		10/92-09/07	DCF190P		1
X-TRAIL (T30) (01-13)	+ AC		06/01-01/13	DCF467P	DCF273K	2
X-TRAIL (T31) (07-13)	+ AC		03/07-11/13	DCF509P	DCF370K	1
OPEL						
ADAM (12-19)			10/12-02/19		DCF201K	1
AGILA A (00-07)			09/00-12/07	DCF227P		1
AGILA A (00-07)			09/00-12/07	DCF526P		1
AGILA B (08-14)			04/08-10/14	DCF460P		1
AMPERA (11-15)			11/11-03/15	DCF564P		1





		LHD  RHD 		Filter Type P	Filter Type K	Pack Quantity
OPEL <i>continued</i>						
AMPERA (11-15)			11/11-03/15	DCF564P		
ANTARA (06-)			05/06-	DCF371P		1
ASTRA F (91-01)			09/91-03/01	DCF541P		1
ASTRA F CLASSIC (98-05)			01/98-01/05	DCF476P	DCF200K	1
ASTRA G (98-09)	BEHR		02/98-12/09	DCF482P	DCF198K	1
ASTRA G (98-09)	DELPHI		02/98-12/09	DCF476P	DCF200K	1
ASTRA G CLASSIC (09-)			12/06-	DCF476P	DCF200K	1
ASTRA H (04-14)	BEHR		01/04-05/14	DCF482P	DCF198K	1
ASTRA H (04-14)	DELPHI		01/04-05/14	DCF476P	DCF200K	1
ASTRA J (09-)			09/09-	DCF564P		
CALIBRA (90-97)			08/89-07/97	DCF541P		1
CASCADA (13-19)			03/13-04/19	DCF564P		
COMBO B (94-01)	- AC		07/94-10/01	DCF031P		1
COMBO B (94-01)	+ AC		07/94-10/01	DCF541P		1
COMBO C (01-)	- AC		10/01-	DCF031P		1
COMBO C (01-)	+ AC		10/01-	DCF541P		1
COMBO D (12-)		LHD	02/12-	DCF485P		1
COMBO D (12-)		RHD	02/12-	DCF488P	DCF201K	1
COMBO E (18-)		RHD	07/94-10/01	DCF488P	DCF201K	1
COMBO E (18-)	- AC		07/94-10/01	DCF031P		1
COMBO E (18-)	+ AC		07/94-10/01	DCF541P		1
CORSA B (93-02)	- AC	LHD	03/93-12/02	DCF031P		1
CORSA B (93-02)	+ AC	LHD	03/93-12/02	DCF541P		1
CORSA B (93-02)	+ AC	RHD	03/93-12/02	DCF193P		1
CORSA C (00-09)			09/00-12/09	DCF481P	DCF223K	1
CORSA D (06-14)			07/06-08/14	DCF488P	DCF201K	1
CORSA E (14-)	- AC		09/14-	DCF488P		1
CORSA E (14-)	+/-		09/14-		DCF201K	1
INSIGNIA (A) (08-17)			07/08-03/17	DCF564P		
KARL (15-19)			01/15-03/18	DCF564P		
MERIVA A (03-10)			05/03-05/10	DCF510P	DCF199K	1
MERIVA B (10-17)			06/10-03/17	DCF564P		
MOKKA (12-)			06/12-	DCF564P		
MOVANO A (98-)			07/98-	DCF418P	DCF052K	1
MOVANO B (10-)			05/10-	DCF568P		2
OMEGA B (94-03)			03/94-07/03		DCF196K	1
SIGNUM (03-08)			05/03-12/08	DCF481P	DCF223K	1
SINTRA (96-99)	+ AC		11/96-04/99	DCF550P		2
TIGRA (94-00)	- AC		07/94-12/00	DCF031P		1
TIGRA (94-00)	+ AC		07/94-12/00	DCF541P		1
TIGRA TwinTop (04-10)	- AC		06/04-12/10	DCF031P		1
VECTRA C (02-08)			04/02-01/09	DCF481P	DCF223K	1
VIVARO A (01-)			08/01-	DCF418P		1
VIVARO B (14-)			06/14-	DCF586P		
ZAFIRA A (99-05)	BEHR		04/99-06/05	DCF482P	DCF198K	1
ZAFIRA A (99-05)	DELPHI		04/99-06/05	DCF476P	DCF200K	1
ZAFIRA B (05-14)			07/05-04/15	DCF482P	DCF198K	1
ZAFIRA Tourer C (11-)			10/11-	DCF564P		
PEUGEOT						
107 (05-14)	+ AC		06/05-05/14	DCF562P		1
108 (14-)			05/14-	DCF585P		1
206 (98-)			08/98-	DCF493P	DCF460K	1
206 CC (00-08)			09/00-12/07	DCF493P	DCF460K	1
206+ (09-13)			01/09-08/13	DCF493P	DCF460K	1
207 (06-15)			02/06-12/15	DCF560P		2
208 I (12-)			03/12-	DCF560P		2
307 (00-12)			08/00-12/09	DCF470P	DCF071K	1
308 CC (07-14)			04/09-12/14	DCF470P	DCF071K	1
308 I (07-14)			09/07-10/14	DCF470P	DCF071K	1
308 II (13-)			11/13-		DCF071K	1
406 (95-04)			11/95-10/04		DCF351K	1
406 Coupe (97-04)			03/97-12/04		DCF351K	1
407 (04-11)			03/04-02/11		DCF211K	1
407 Coupe (05-)			10/05-		DCF211K	1
408 (10-)			01/12-		DCF071K	1
607 (00-11)			02/00-07/11		DCF347K	1
807 (02-)			06/02-	DCF532P	DCF072K	1
1007 (05-)			04/05-	DCF470P	DCF071K	1





		LHD  RHD 		Filter Type P	Filter Type K	Pack Quantity
PEUGEOT continued						
1007 (05-)			04/05-	DCF470P	DCF071K	1
2008 I (13-)			03/13-	DCF560P		2
3008 (09-16)	+ Auto CC		06/09-08/16		DCF073K	2
3008 (09-16)	+ Auto climate control		06/09-08/16	DCF479P		2
3008 SUV (16-)	+ Auto CC		05/16-		DCF073K	2
3008 SUV (16-)	+ Auto climate control		05/16-	DCF479P		2
4007 (07-13)			02/07-03/13	DCF467P	DCF344K	1
4008 (12-)			05/12-	DCF467P	DCF344K	1
5008 I (09-17)	+ Auto CC		06/09-03/17		DCF073K	2
5008 I (09-17)	+ Auto climate control		06/09-03/17	DCF479P		2
BIPPER (08-)			02/08-	DCF485P		1
BOXER (94-02)			03/94-04/02	DCF536P		1
BOXER (02-)			04/02-	DCF536P		1
BOXER (06-)			04/06-	DCF454P		1
EXPERT (96-06)			02/96-12/06	DCF536P		1
EXPERT (07-)			01/07-		DCF332K	1
EXPERT (16-)			04/16-		DCF073K	1
EXPERT (16-)			04/16-	DCF479P		2
PARTNER / RANCH (96-15)			05/96-07/11	DCF018P		1
PARTNER / RANCH (96-15)			05/96-07/11	DCF540P		1
PARTNER / RANCH (08-)			04/08-		DCF073K	1
PARTNER / RANCH (08-)			04/08-	DCF479P		2
RCZ (10-15)			03/10-12/15	DCF470P	DCF071K	1
TRAVELLER (16-)			04/16-	DCF470P	DCF071K	1
PORSCHE						
911 (993) (93-97)			10/93-09/97		DCF351K	1
911 (996) (97-05)			09/97-08/05		DCF351K	1
911 (997) (04-12)			07/04-12/12		DCF351K	1
BOXSTER (986) (96-04)			09/96-12/04		DCF351K	1
BOXSTER (987) (04-12)			11/04-03/12		DCF351K	1
CAYENNE (955) (02-10)			09/02-09/10	DCF477P	DCF234K	1
CAYMAN (987) (05-12)			11/05-06/13		DCF351K	1
MACAN (95B) (14-)			02/14-	DCF571P		1
PANAMERA (970) (09-16)			09/09-07/13	DCF462P	DCF458K	1
RENAULT						
CAPTUR I (13-)	+ AC		06/13-	DCF579P		1
CLIO II (98-)	+ AC		09/98-12/10	DCF502P		1
CLIO IV (12-)	+ AC		11/12-	DCF579P		1
ESPACE IV (02-)	+ AC		11/02-		DCF221K	1
ESPACE V (15-)	+ AC		02/15-	DCF588P		1
FLUENCE (10-)	+ AC		02/10-	DCF565P		1
Grand SCÉNIC II (04-09)	+ AC		04/04-06/09	DCF414P		1
Grand SCÉNIC III (09-)	+ AC		02/09-	DCF586P		1
KADJAR (15-)	+ AC		06/15-	DCF588P		1
KANGOO (97-)	+ AC		08/97-	DCF502P		1
KANGOO (08-)	+ AC		02/08-	DCF568P		2
LAGUNA II (01-07)	+ AC		03/01-12/07	DCF492P		1
LOGAN I (04-)	+ AC		09/04-	DCF502P		1
LOGAN II (13-)	+ AC		11/13-	DCF579P		1
MASTER II (98-)	+ AC		07/98-	DCF219P		1
MASTER III (10-)	+ AC		02/10-	DCF568P		2
MEGANE I (96-03)	+ AC		08/95-12/04	DCF502P		1
MEGANE II (02-12)	+ AC		09/02-	DCF413P		1
MEGANE IV (15-)	+ AC		11/15-	DCF588P		1
MEGANE Scénic (96-99)	+ AC	LHD	10/96-10/99	DCF270P		1
MEGANE Scénic (96-99)	+ AC	LHD	10/96-10/99	DCF416P		1
SANDERO II (Stepway) (13-)	+ AC		11/13-	DCF579P		1
SCÉNIC II (03-10)	+ AC		06/03-12/09	DCF414P		1
SCÉNIC III (09-)	+ AC		02/09-	DCF586P		1
TALISMAN (15-)	+ AC		06/15-	DCF588P		1
THALIA I (98-)	+ AC		02/98-	DCF502P		1
THALIA II (08-)	+ AC		09/08-	DCF502P		1
THALIA III (13-)	+ AC		12/13-	DCF502P		1
TRAFIC II (01-)	+ AC		03/01-	DCF418P		1
TRAFIC III (14-)	+ AC		05/14-	DCF586P		1
VEL SATIS (02-)	+ AC		06/02-	DCF492P		1
ROLLS-ROYCE						
PHANTOM VII (02-17)			01/03-07/17	DCF064P	DCF065K	2

		LHD  RHD 		Filter Type P	Filter Type K	Pack Quantity
ROVER						
PHANTOM VII (02-17)			01/03-07/17	DCF064P	DCF065K	2
45 (00-05)	- AC		02/00-05/05	DCF109P		1
200 (RF) (95-00)			11/95-03/00	DCF109P		1
200 (XW) (89-99)			01/96-12/97	DCF109P		1
400 (95-00)	- AC		03/95-03/00	DCF109P		1
MINI (91-01)			08/90-05/01	DCF061P	DCF063K	1
SAAB						
9-3 (02-15)			09/02-02/15	DCF481P	DCF223K	1
9-3X (09-15)			02/09-02/15	DCF481P		1
SEAT						
ALHAMBRA (7V) (96-10)			04/96-03/10	DCF500P	DCF094K	1
ALHAMBRA (710) (10-)		LHD	06/10-	DCF449P	DCF052K	1
ALHAMBRA (710) (10-)		RHD	11/12-		DCF053K	1
ALTEA (XL) (5P) (04-)		LHD	03/04-	DCF449P	DCF052K	1
ALTEA (XL) (5P) (04-)		RHD	06/09-		DCF053K	1
AROSA (6H) (97-04)			05/97-06/04	DCF461P	DCF225K	1
ATECA (KH7) (16-)			04/16-	DCF575P		1
CORDOBA (6K1) (93-99)			02/93-12/02	DCF461P	DCF225K	1
CORDOBA (6K2) (99-02)			06/99-12/02	DCF461P	DCF225K	1
CORDOBA (6L) (02-09)			09/02-11/09	DCF462P	DCF458K	1
EXEO (3R) (08-13)			12/08-05/13	DCF463P	DCF054K	1
IBIZA II (6K1) (93-99)			03/93-02/02	DCF461P	DCF225K	1
IBIZA II (6K2) (99-02)			08/99-02/02	DCF461P	DCF225K	1
IBIZA III (6L) (02-09)			02/02-11/09	DCF462P	DCF458K	1
IBIZA IV (6J, 6P) (08-17)			03/08-06/17	DCF462P	DCF458K	1
IBIZA IV (6J, 6P) (08-17)			03/08-06/17	DCF576P		1
IBIZA V (KJ1) (17-)			12/17-	DCF576P		1
INCA (6K9) (95-03)			11/95-06/03	DCF461P	DCF225K	1
LEON (1M) (99-06)			11/99-06/06	DCF449P	DCF052K	1
LEON (1P) (05-12)			05/05-08/13	DCF449P	DCF052K	1
LEON (5F) (12-)			09/12-	DCF575P		1
MII (KF1) (11-)	+ AC		10/11-07/19	DCF583P		1
TOLEDO II (1M) (99-06)			10/98-05/06	DCF461P	DCF225K	1
TOLEDO III (5P) (04-09)			04/04-05/09	DCF449P	DCF052K	1
TOLEDO IV (KG3) (12-19)			07/12-04/19	DCF576P		1
SKODA						
CITIGO (11-)	+ AC		10/11-08/19	DCF583P		1
FABIA I (6Y) (99-08)			08/99-03/08	DCF462P	DCF458K	1
FABIA II (06-14)			12/06-12/14	DCF462P	DCF458K	1
FABIA III (NJ) (14-)			08/14-	DCF576P		1
OCTAVIA I (1U) (96-10)			09/96-12/10	DCF461P	DCF225K	1
OCTAVIA II (1Z) (04-13)			02/04-06/13	DCF449P		1
OCTAVIA II (1Z) (04-13)		LHD	02/04-06/13		DCF052K	1
OCTAVIA III (5E) (12-)			11/12-	DCF575P		1
RAPID (HN) (12-19)			07/12-12/19	DCF576P		1
ROOMSTER (5J) (06-15)			03/06-05/15	DCF462P	DCF458K	1
SUPERB I (3U) (01-08)			12/01-03/08	DCF461P	DCF225K	1
SUPERB II (3T) (08-15)			03/08-05/15	DCF449P	DCF052K	1
SUPERB III (3V) (15-)			03/15-	DCF575P		1
YETI (5L) (09-17)			05/09-12/17	DCF449P	DCF052K	1
SMART						
CABRIO (450) (00-04)			03/00-01/04		DCF345K	1
CITY-Coupe (450) (98-04)			07/98-01/04		DCF345K	1
CROSSBLADE (450) (02-03)			06/02-12/03		DCF345K	1
FORFOUR I (454) (04-06)			01/04-06/06	DCF305P	DCF181K	1
FORTWO (450) (04-07)			01/04-02/07		DCF345K	1
FORTWO (451) (07-)			01/07-		DCF345K	1
ROADSTER (452) (03-05)			04/03-11/05	DCF305P	DCF181K	1
SUBARU						
BRZ (12-)			06/12-	DCF466P		1
FORESTER (02-08)			02/02-12/08	DCF467P		1
JUSTY II (95-03)			10/95-11/03	DCF227P		1
JUSTY II (95-03)			10/95-11/03	DCF526P		1
JUSTY III (03-)			09/03-	DCF227P		1
JUSTY III (03-)			09/03-	DCF526P		1
LEGACY III (98-03)			10/98-08/03	DCF357P	DCF239K	2
LEGACY III (98-03)	+ AC		10/98-08/03	DCF326P		2
LEGACY IV (03-09)			09/03-12/09	DCF357P	DCF239K	1

		LHD  RHD 		Filter Type P	Filter Type K	Pack Quantity
SUBARU <i>continued</i>						
LEGACY IV (03-09)			09/03-12/09	DCF357P	DCF239K	1
LEGACY OUTBACK (96-99)			01/96-12/99	DCF357P	DCF239K	1
LEGACY V (09-14)			09/09-12/14	DCF382P		1
OUTBACK (00-03)			10/00-08/03	DCF357P	DCF239K	1
OUTBACK (00-03)	+ AC		10/00-08/03	DCF326P		2
OUTBACK (03-09)			11/03-09/09	DCF357P	DCF239K	1
OUTBACK (09-)			09/09-	DCF382P	DCF239K	1
TREZIA (11-)			03/11-	DCF382P		1
TRIBECA (05-)			01/05-		DCF239K	1
SUZUKI						
ALTO VI (02-08)			09/04-12/08	DCF376P		1
ALTO VII (09-)			01/09-	DCF376P		1
BALENO (16-)			02/16-	DCF466P		1
CELERIO (14-)		For left-/right-hand drive vehicles	03/14-	DCF381P		1
Grand VITARA I (98-06)	+ AC		03/98-10/02	DCF374P		2
Grand VITARA I (98-06)	+ AC		11/02-08/06	DCF230P		1
Grand VITARA II (05-)			04/05-	DCF377P		1
IGNIS I (00-05)			10/00-12/05	DCF227P		1
IGNIS I (00-05)			10/00-12/05	DCF526P		1
IGNIS II (03-)			09/03-	DCF227P		1
IGNIS II (03-)			09/03-	DCF526P		1
JIMNY (98-)			09/98-	DCF379P		1
KIZASHI (10-)			10/10-	DCF380P		1
LIANA (01-07)			07/01-12/07	DCF330P		1
SPLASH (08-)			01/08-	DCF460P		1
SPLASH (08-)			08/12-	DCF460P		1
SWIFT III (05-)			02/05-	DCF466P		1
SWIFT IV (10-)			10/10-	DCF466P		1
SX4 (06-)	Hungary		06/06-	DCF466P		1
SX4 (06-)	JPN		06/06-	DCF378P		1
SX4 S-Cross (13-)			08/13-	DCF590P		1
VITARA (15-)			02/15-	DCF590P		1
WAGON R (03-05)			06/04-08/05	DCF227P		1
WAGON R (03-05)			06/04-08/05	DCF526P		1
WAGON R+ (98-00)			02/98-05/00	DCF227P		1
WAGON R+ (98-00)			02/98-05/00	DCF526P		1
WAGON R+ (00-)			05/00-	DCF227P		1
WAGON R+ (00-)			05/00-	DCF526P		1
TOYOTA						
4 RUNNER (N10) (89-96)			08/89-03/96	DCF353P	DCF384K	1
4 RUNNER (N18) (95-02)			11/95-11/02	DCF353P	DCF384K	1
4 RUNNER (N5) (87-89)			08/87-07/89	DCF353P	DCF384K	1
ALLION I (01-07)			06/01-04/05	DCF353P	DCF384K	1
ALPHARD II (08-14)			04/08-12/14	DCF382P	DCF385K	1
AURIS (E15) (06-12)			10/06-09/12	DCF382P	DCF385K	1
AURIS (E18) (12-18)			10/12-12/18	DCF382P	DCF385K	1
AVENSIS (97-03)			09/97-02/03	DCF361P		1
AVENSIS (03-09)			01/03-11/08	DCF469P		1
AVENSIS (08-18)			11/08-10/18	DCF382P	DCF385K	1
AVENSIS (08-18)			11/08-10/18	DCF469P		1
AVENSIS Verso (01-09)			08/01-11/09	DCF353P	DCF384K	1
AYGO (05-14)	+ AC		07/05-05/14	DCF562P		1
AYGO (14-)			05/14-	DCF585P		1
CAMRY (V3) (01-06)			08/01-11/06	DCF353P	DCF384K	1
CAMRY (V4) (06-11)			01/06-12/14	DCF382P	DCF385K	1
CAMRY (V5) (11-)			08/11-	DCF382P	DCF385K	1
CAMRY (V7) (17-)		For left-/right-hand drive vehicles	08/17-	DCF386P	DCF387K	1
CARINA E (92-97)			04/92-09/97	DCF361P		1
CELICA (99-05)			08/99-09/05	DCF353P	DCF384K	1
C-HR (16-)		For left-/right-hand drive vehicles	10/16-	DCF386P	DCF387K	1
C-HR (16-)		For left-/right-hand drive vehicles	10/16-	DCF388P		1





		LHD  RHD 		Filter Type P	Filter Type K	Pack Quantity
TOYOTA continued						
C-HR (16-)		For left-/right-hand drive vehicles	10/16-	DCF388P		1
COROLLA (E12) (01-07)	JPN		08/00-03/08	DCF383P		1
COROLLA (E12) (01-07)	UK		08/00-03/08	DCF469P		1
COROLLA (E14, E15) (06-14)			10/06-07/14	DCF382P	DCF385K	1
COROLLA (E14, E15) (06-14)	JPN		10/06-07/14	DCF382P		1
COROLLA (E18) (13-18)			06/13-12/18	DCF382P	DCF385K	1
COROLLA (E21) (18-)			10/18-	DCF386P	DCF387K	1
COROLLA Verso (E12) (01-09)	JPN		08/01-03/09	DCF383P		1
COROLLA Verso (E12) (01-09)			02/04-03/09	DCF469P		1
CORONA (T19) (92-97)			10/91-09/97	DCF361P		2
FJ CRUISER (07-18)			12/10-01/18		DCF239K	1
FORTUNER (04-15)			06/04-05/15	DCF382P	DCF385K	1
GT 86 (12-)			03/12-	DCF466P		1
HIACE V (04-)			06/04-	DCF382P		1
HILUX III (05-)			11/04-	DCF382P	DCF385K	1
HILUX III (05-)			11/04-	DCF473P		1
HILUX IV (15-)		For left-/right-hand drive vehicles	05/15-	DCF386P	DCF387K	1
KLUGER / HIGHLANDER II (07-14)			06/07-02/14	DCF382P	DCF385K	1
LAND CRUISER (J100) (98-08)			01/98-08/07	DCF353P	DCF384K	1
LAND CRUISER (J200) (07-)			08/07-	DCF353P	DCF384K	1
LAND CRUISER (J200) (07-)			08/07-	DCF382P	DCF385K	1
LAND CRUISER / PRADO (J120) (02-10)			09/02-12/10	DCF353P	DCF384K	1
LAND CRUISER / PRADO (J150) (10-)			08/09-	DCF353P	DCF384K	1
LAND CRUISER / PRADO (J150) (10-)			08/09-	DCF382P	DCF385K	1
LAND CRUISER / PRADO / COLORADO (J90) (95-02)			04/95-12/02	DCF353P	DCF384K	1
MIRAI (14-)			10/14-	DCF382P	DCF385K	1
PICNIC (96-01)			05/96-12/01	DCF361P		1
PREVIA / ESTIMA I (90-00)			01/90-08/00	DCF353P	DCF384K	1
PREVIA / ESTIMA II (00-06)			02/00-02/06	DCF353P	DCF384K	1
PRIUS (W1) (00-04)			05/00-01/04	DCF357P		1
PRIUS (W2) (03-09)			09/03-12/09	DCF353P	DCF384K	1
PRIUS (W3) (09-)			06/08-	DCF382P	DCF385K	1
PRIUS (W5) (15-)		For left-/right-hand drive vehicles	09/15-	DCF386P	DCF387K	1
PRIUS Plus (W4) (11-)			05/11-	DCF382P	DCF385K	1
PROACE (13-16)			06/13-03/16		DCF332K	1
PROACE (16-)			02/16-	DCF479P	DCF073K	1
RAV 4 I / FUNCRAUISER (94-00)			01/94-09/00	DCF357P		1
RAV 4 II (00-05)			05/00-11/05	DCF357P		1
RAV 4 III (05-13)			11/05-12/13	DCF382P	DCF385K	1
RAV 4 IV (12-)			12/12-	DCF382P	DCF385K	1
RAV 4 V (18-)			12/18-	DCF386P	DCF387K	1
TUNDRA (07-)			11/06-	DCF382P	DCF385K	1
URBAN CRUISER (07-16)			07/07-03/16	DCF382P	DCF385K	1
VENZA (08-16)			11/08-11/16	DCF382P	DCF385K	1
VERSO (09-18)			04/09-08/18	DCF382P	DCF385K	1
VERSO S (10-16)			11/10-10/16	DCF382P	DCF385K	1
VIOS / YARIS (07-13)			09/05-10/13	DCF353P	DCF239K	1
VIOS / YARIS (07-13)			09/05-10/13	DCF357P	DCF385K	1
VIOS / YARIS (07-13)			09/05-10/13	DCF382P		1
WISH (03-09)			04/03-05/05	DCF357P		1
YARIS (99-05)			04/99-11/05	DCF353P	DCF384K	1
YARIS (99-05)			04/99-11/05	DCF357P		1
YARIS (05-11)			08/05-12/12	DCF382P	DCF385K	1
YARIS (10-)			12/10-	DCF382P	DCF385K	1
YARIS VERSO (99-05)			08/99-09/05	DCF353P	DCF239K	1
YARIS VERSO (99-05)			08/99-09/05	DCF357P	DCF384K	1
UAZ						
PATRIOT (04-)			07/04-	DCF504P		
VAUXHALL						
ADAM (12-19)			10/12-04/19		DCF201K	1
AGILA I (A) (00-08)			02/00-03/08	DCF227P		1
AGILA I (A) (00-08)			02/00-03/08	DCF526P		1
AGILA II (B) (08-14)			01/08-11/14	DCF460P		1

		LHD  RHD 		Filter Type P	Filter Type K	Pack Quantity
VAUXHALL continued						
AGILA II (B) (08-14)			01/08-11/14	DCF460P		1
AMPERA (12-)			03/12-	DCF564P		
ANTARA (06-)			08/06-	DCF371P		1
ASTRA II (84-94)			09/84-08/93	DCF541P		1
ASTRA III (F) (91-01)			03/91-03/01	DCF541P		1
ASTRA IV (G) (98-06)	BEHR		02/98-08/06	DCF482P	DCF198K	1
ASTRA IV (G) (98-06)	DELPHI		02/98-08/06	DCF476P	DCF200K	1
ASTRA V (H) (04-10)			01/04-12/13	DCF476P	DCF200K	1
ASTRA V (H) (04-10)	BEHR		03/05-12/13	DCF482P	DCF198K	1
ASTRA V (H) (04-10)	DELPHI		03/05-12/13	DCF476P	DCF200K	1
ASTRA VI (J) (09-15)			12/09-10/15	DCF564P		
CALIBRA (90-97)			06/90-07/97	DCF541P		1
CASCADA (13-)			02/13-	DCF564P		
COMBO I (B) (94-01)	- AC		07/94-10/01	DCF031P		1
COMBO I (B) (94-01)	+ AC		07/94-10/01	DCF541P		1
COMBO II (C) (01-12)	- AC		09/01-02/12	DCF031P		1
COMBO II (C) (01-12)	+ AC		09/01-02/12	DCF541P		1
COMBO III (D) (11-)		LHD	11/11-	DCF485P		1
COMBO III (D) (11-)		RHD	11/11-	DCF488P	DCF201K	1
CORSA I (B) (93-00)	- AC		12/92-09/00	DCF031P		1
CORSA I (B) (93-00)	+ AC		12/92-09/00	DCF541P		1
CORSA II (C) (00-06)			08/00-04/07	DCF481P	DCF223K	1
CORSA III (D) (06-)			07/06-	DCF488P	DCF201K	1
CORSA IV (E) (14-)			08/14-	DCF488P	DCF201K	1
INSIGNIA I (A) (08-17)			07/08-05/17	DCF564P		
MERIVA I (A) (03-10)			01/03-06/10	DCF510P	DCF199K	1
MERIVA II (B) (10-)			06/10-	DCF564P		
MOKKA (12-)			06/12-	DCF564P		
MOVANO II (B) (10-)			05/10-	DCF568P		2
OMEGA (B) (94-03)			01/94-07/03		DCF196K	1
SIGNUM (02-08)			03/03-10/08	DCF481P	DCF223K	1
SINTRA (96-99)			11/96-04/99	DCF550P		1
TIGRA (94-00)	- AC		07/94-12/00	DCF031P		1
TIGRA (94-00)	+ AC		07/94-12/00	DCF541P		1
TIGRA TwinTop (04-09)	- AC		06/04-08/09	DCF031P		1
TIGRA TwinTop (04-09)	+ AC		06/04-08/09	DCF541P		1
VECTRA II (C) (00-08)			01/00-05/09	DCF481P	DCF223K	1
VIVA (15-19)			01/15-03/18	DCF564P		
VIVARO (A) (01-14)			08/01-07/14	DCF418P		1
VIVARO (B) (14-)			05/14-	DCF586P		
ZAFIRA I (A) (98-05)	+ AC, DELPHI		11/98-08/05	DCF476P	DCF200K	1
ZAFIRA I (A) (98-05)	BEHR		11/98-08/05	DCF482P	DCF198K	1
ZAFIRA II (B) (05-14)			04/05-11/14	DCF482P	DCF198K	1
ZAFIRA III (C) (11-18)			10/11-08/18	DCF564P		
VOLVO						
C30 (06-12)			10/06-12/12	DCF465P	DCF236K	1
C70 I (97-05)			03/98-10/05		DCF236K	1
C70 II (06-13)			03/06-06/13		DCF236K	1
S40 II (04-12)			01/04-12/12		DCF236K	1
S60 I (00-10)		LHD	07/00-04/10	DCF494P	DCF343K	1
S60 I (00-10)		RHD	07/00-04/10		DCF352K	1
S60 II (10-18)			04/10-12/18	DCF566P		1
S80 I (98-08)		LHD	05/98-07/06	DCF494P	DCF343K	1
S80 I (98-08)		RHD	05/98-07/06		DCF352K	1
S80 II (06-16)			03/06-12/16	DCF566P		1
V50 (04-12)			12/03-12/12		DCF236K	1
V60 I (10-18)			07/10-12/18	DCF566P		1
V70 II (00-07)		LHD	11/99-12/08	DCF494P	DCF343K	1
V70 II (00-07)		RHD	11/99-12/08		DCF352K	1
V70 III (07-)			04/07-04/16	DCF566P		1
XC60 I (08-17)			05/08-12/17	DCF566P		1
XC70 I Cross Country (97-07)		LHD	03/00-08/07	DCF494P	DCF343K	1
XC70 I Cross Country (97-07)		RHD	03/00-08/07		DCF352K	1
XC70 II (07-16)			04/07-12/16	DCF566P		1
XC90 I (02-14)		LHD	10/02-12/14	DCF494P	DCF343K	1
XC90 I (02-14)		RHD	10/02-12/14		DCF352K	1
VW						
AMAROK (2H, S1) (10-)			09/10-	DCF477P		1

		LHD  RHD 		Filter Type P	Filter Type K	Pack Quantity
VW continued						
AMAROK (2H, S1) (10-)			09/10-	DCF477P		1
BEETLE (5C) (11-19)			04/11-07/19	DCF449P		1
BORA (1J) (98-05)			10/98-12/13	DCF461P	DCF002K	1
CADDY II (9K, 9U) (95-04)			11/95-01/04	DCF461P	DCF225K	1
CADDY III (2K, 2C) (04-15)			03/04-05/15	DCF449P	DCF052K	1
CADDY IV (SA) (15-)			05/15-	DCF449P	DCF052K	1
CC (358) (11-16)			11/11-12/16	DCF449P	DCF052K	1
CORRADO (53I) (88-95)			09/88-12/95	DCF461P	DCF225K	1
CRAFTER 30-50 (2E, 2F) (06-16)			04/06-12/16	DCF511P	DCF081K	1
CRAFTER (16-)			09/16-	DCF575P		1
EOS (1F) (06-15)			03/06-08/15	DCF449P	DCF052K	1
FOX (5Z) (03-11)			04/05-12/11	DCF462P	DCF458K	1
GOLF III (1H, 1E) (91-99)			10/91-04/99	DCF461P	DCF225K	1
GOLF IV (1J, 1E) (97-06)			08/97-06/06	DCF461P	DCF002K	1
GOLF Plus (5M, 521) (05-14)			12/04-12/13	DCF449P	DCF052K	1
GOLF Sportsvan (AM1) (14-)			02/14-	DCF575P		1
GOLF V (1K) (03-09)			10/03-07/09	DCF449P	DCF052K	1
GOLF VI (5K, AJ5) (08-14)			10/08-05/14	DCF449P	DCF052K	1
GOLF VI (5K, AJ5) (08-14)		LHD	07/09-07/13		DCF052K	1
GOLF VI Convertible (517) (11-16)			03/11-05/16	DCF449P	DCF052K	1
GOLF VII (5G, BA5) (12-)			08/12-	DCF575P		1
JETTA III (1K2) (05-10)			09/04-10/10	DCF449P	DCF052K	1
JETTA IV (162) (10-)			04/10-	DCF449P		1
JETTA IV (162) (10-)		LHD	04/10-		DCF052K	1
LT 28-35 II (2D) (96-06)			05/96-07/06	DCF537P		1
LT 28-46 II (2D) (96-06)			05/96-07/06	DCF537P		1
LUPO (6X, 6E) (98-05)			09/98-07/05	DCF461P	DCF002K	1
MULTIVAN V (7H, 7E) (03-15)			04/03-08/15	DCF477P	DCF234K	1
MULTIVAN VI (SG) (15-)			04/15-	DCF477P	DCF234K	1
NEW BEETLE (9C, 1C, 1Y) (98-10)			01/98-10/10	DCF461P	DCF002K	1
PASSAT (3A2, 35I) (88-97)			02/88-07/94	DCF287P		1
PASSAT (3B2, 3B5) (96-01)			08/96-11/00	DCF508P	DCF050K	1
PASSAT (3B3, 3B6) (00-05)			11/00-11/05	DCF461P	DCF002K	1
PASSAT (3B3, 3B6) (00-05)			11/00-11/05	DCF508P	DCF050K	1
PASSAT (3C) (05-11)			03/05-10/11	DCF449P	DCF052K	1
PASSAT (3G) (14-)			08/14-	DCF575P		1
PASSAT (362, 365) (10-14)			08/10-12/15	DCF449P	DCF052K	1
PASSAT CC (357) (08-12)			02/08-01/12	DCF449P	DCF052K	1
PHAETON (3D) (02-16)			04/02-03/16		DCF231K	2
POLO (6N1) (94-99)			10/94-12/99	DCF461P	DCF002K	1
POLO (6N1) (94-99)			10/94-12/99		DCF225K	1
POLO (6N2) (99-01)			10/99-09/01	DCF461P	DCF225K	1
POLO (6R, 6C) (09-)			03/09-	DCF462P	DCF458K	1
POLO (6R, 6C) (09-)			03/09-	DCF576P		1
POLO (9N) (01-09)			10/01-11/09	DCF462P	DCF458K	1
POLO (86C, 80) (81-94)			08/92-07/94	DCF461P	DCF002K	1
POLO Classic (6KV) (95-02)			11/95-01/02	DCF461P	DCF225K	1
POLO Saloon (9A4) (02-)			09/02-	DCF462P	DCF458K	1
POLO Variant (6V5) (97-01)			05/97-09/01	DCF461P	DCF225K	1
SCIROCCO (137, 138) (08-17)			05/08-11/17	DCF449P	DCF052K	1
SCIROCCO (137, 138) (08-17)		LHD	01/13-11/17		DCF052K	1
SCIROCCO (137, 138) (08-17)		RHD	01/13-11/17		DCF053K	1
SHARAN (7M) (95-10)			09/95-03/10	DCF500P	DCF094K	1
SHARAN (7N) (10-)			05/10-	DCF449P	DCF094K	1
SHARAN (7N) (10-)			05/10-	DCF500P		1
SHARAN (7N) (10-)		LHD	05/11-		DCF052K	1
SHARAN (7N) (10-)		RHD	05/11-		DCF053K	1
TIGUAN (5N) (07-18)			09/07-07/18	DCF449P	DCF052K	1
TIGUAN (AD) (16-)			01/16-	DCF575P		1
TOUAREG (7L) (02-10)			10/02-05/10	DCF477P	DCF234K	1
TOUAREG (7P) (10-18)			01/10-03/18	DCF477P		1
TOURAN (1T1, 1T2) (03-10)			02/03-05/10	DCF449P	DCF052K	1
TOURAN (1T3) (10-15)			05/10-05/15	DCF449P	DCF052K	1
TOURAN (5T) (15-)			05/15-	DCF575P		1
TRANSPORTER IV (70X, 7D) (90-03)			07/90-06/03	DCF446P		1
TRANSPORTER V (7H, 7E, 7J) (03-15)			04/03-08/15	DCF477P	DCF234K	1
TRANSPORTER VI (SF, SG) (15-)			04/15-	DCF477P	DCF234K	1
UP! (12, BL) (11-)	+ AC		08/11-	DCF583P		1

Cabin Air Filter

Application Tables

		LHD  RHD		Filter Type P	Filter Type K	Pack Quantity
VW continued						
UP! (12, BL) (11-)	+ AC		08/11-	DCF583P		1
VENTO (1H2) (91-98)			11/91-09/98	DCF461P	DCF225K	1
XL1 (14-)			02/14-	DCF522P		1
XL1 (14-)			02/14-		DCF122K	2

DENSO Cross Reference Chart



Cabin Air Filter

Cross Reference Chart - OE

1A FIRST AUTOMOTIVE	DENSO
C30001	DCF357P
C30103	DCF507P
C30110	DCF462P
C30110	DCF576P
C30111	DCF461P
C30115-2	DCF522P
C30116	DCF508P
C30117	DCF463P
C30118	DCF449P
C30120	DCF018P
C30122	DCF513P
C30123	DCF540P
C30126	DCF532P
C30128-2	DCF479P
C30129	DCF454P
C30131	DCF061P
C30133	DCF096P
C30134-2	DCF064P
C30134-2	DCF475P
C30137	DCF286P
C30141	DCF504P
C30142	DCF083P
C30144	DCF083P
C30144	DCF497P
C30145	DCF536P
C30147	DCF499P
C30147	DCF580P
C30148	DCF488P
C30149	DCF572P
C30150	DCF096P
C30150	DCF517P
C30152	DCF474P
C30153	DCF500P
C30154	DCF517P
C30159	DCF009P
C30165	DCF412P
C30166	DCF305P
C30170	DCF227P
C30170	DCF526P
C30171	DCF476P
C30172	DCF482P
C30173	DCF541P
C30174	DCF031P
C30176	DCF486P
C30178	DCF510P
C30180	DCF493P
C30186	DCF562P
C30188-2	DCF560P
C30190	DCF502P
C30192	DCF416P
C30196	DCF492P
C30199	DCF270P
C30202	DCF353P
C30203	DCF586P
C30204	DCF469P
C30205	DCF382P
C30208	DCF485P
C30216	DCF268P
C30217	DCF446P
C30218	DCF477P
C30219-2	DCF400P
C30222	DCF405P
C30229	DCF255P
C30231	DCF190P
C30236	DCF016P
C30237-2	DCF402P
C30238-2	DCF403P
C30252	DCF465P
C30253	DCF471P
C30257	DCF480P
C30258	DCF452P
C30259	DCF144P
C30260-2	DCF514P

1A FIRST AUTOMOTIVE	DENSO
C30261	DCF480P
C30262	DCF537P
C30263	DCF521P
C30265-2	DCF563P
C30268	DCF302P
C30271	DCF585P
C30275	DCF588P
C30281	DCF230P
C30281	DCF375P
C30282-2	DCF374P
C30291	DCF353P
C30291	DCF354P
C30295	DCF413P
C30296	DCF502P
C30297-2	DCF568P
C30305	DCF371P
C30317	DCF571P
C30321	DCF075P
C30322	DCF076P
C30323	DCF242P
C30333	DCF467P
C30336	DCF516P
C30340	DCF284P
C30341	DCF280P
C30343	DCF486P
C30344-2	DCF268P
C30345	DCF410P
C30347	DCF966P
C30348-2	DCF266P
C30351	DCF109P
C30352-2	DCF512P
C30354	DCF466P
C30355	DCF466P
C30356	DCF561P
C30359	DCF564P
C30360	DCF460P
C30361	DCF210P
C30361	DCF408P
C30362-2	DCF283P
C30363	DCF467P
C30365	DCF590P
C30366	DCF263P
C30366	DCF577P
C30367	DCF483P
C30372-2	DCF279P
C30375	DCF411P
C30377-2	DCF187P
C30378	DCF509P
C30380	DCF326P
C30381	DCF330P
C30384-2	DCF361P
C30385-2	DCF285P
C30386	DCF566P
C30388	DCF567P
C30389-2	DCF303P
C30390	DCF418P
C30394-2	DCF423P
C30396	DCF306P
C30398-2	DCF570P
C30400	DCF582P
C30405-2	DCF159P
C30408	DCF565P
C30411	DCF376P
C30412	DCF377P
C30414	DCF383P
C30415	DCF573P
C30416	DCF569P
C30427	DCF584P
C30429	DCF380P
C30434	DCF589P
C30435	DCF471P
C30436	DCF578P
C30438	DCF587P

1A FIRST AUTOMOTIVE	DENSO
C30440	DCF581P
C30455	DCF473P
C30457	DCF243P
C30466	DCF574P
C30472	DCF386P
C30480	DCF245P
C30485	DCF575P
C30486	DCF576P
C30489	DCF388P
C30511	DCF579P
C35103	DCF042P
C35162	DCF467P
K30001	DCF239K
K30102-2	DCF048K
K30103	DCF044K
K30110	DCF458K
K30111	DCF002K
K30111	DCF225K
K30112	DCF002K
K30115-2	DCF122K
K30116	DCF050K
K30117	DCF054K
K30118	DCF052K
K30128-2	DCF073K
K30131	DCF063K
K30133	DCF450K
K30136	DCF340K
K30143	DCF090K
K30144	DCF450K
K30148	DCF201K
K30155	DCF105K
K30156	DCF094K
K30159	DCF068K
K30160	DCF035K
K30161	DCF152K
K30163	DCF345K
K30165	DCF341K
K30166	DCF181K
K30167-2	DCF163K
K30168	DCF170K
K30176	DCF223K
K30180	DCF460K
K30182	DCF351K
K30183	DCF071K
K30185	DCF211K
K30218	DCF234K
K30220	DCF059K
K30236	DCF062K
K30237-2	DCF015K
K30238-2	DCF419K
K30252	DCF236K
K30253	DCF106K
K30258	DCF453K
K30259	DCF252K
K30263	DCF172K
K30264	DCF081K
K30266	DCF300K
K30288	DCF385K
K30312	DCF072K
K30312	DCF343K
K30376-2	DCF168K
K30383-2	DCF231K
K30392	DCF080K
K30445	DCF053K
K30456	DCF118K
K30458	DCF120K
K30472	DCF387K
K35118	DCF053K

ACDelco	DENSO
PU1005E	DCF492P
PU1006-2E	DCF550P
PU1007E	DCF018P
PU1009E	DCF504P
PU1015E	DCF270P
PU1021E	DCF462P
PU1026E	DCF268P
PU1028-2E	DCF514P
PU1029E	DCF287P
PU1030E	DCF482P
PU1034E	DCF461P
PU1035E	DCF009P
PU1039E	DCF502P
PU1040-2E	DCF400P
PU1041E	DCF042P
PU1041E	DCF507P
PU1043E	DCF416P
PU1044E	DCF463P
PU1045E	DCF476P
PU1046E	DCF193P
PU1050E	DCF144P
PU1052E	DCF486P
PU1058E	DCF493P
PU1059E	DCF031P
PU1064E	DCF474P
PU1068E	DCF141P
PU1070E	DCF541P
PU1072E	DCF536P
PU1073E	DCF096P
PU1073E	DCF517P
PU1074E	DCF500P
PU1075E	DCF016P
PU1084E	DCF449P
PU1096E	DCF537P
PU1122E	DCF508P
PU1124E	DCF109P
PU1126-2E	DCF266P
PU1128E	DCF227P
PU1128E	DCF526P
PU1129E	DCF469P
PU1133E	DCF477P
PU1134E	DCF190P
PU1137E	DCF366P
PU1139-2E	DCF159P
PU1140E	DCF540P
PU1144E	DCF561P
PU1146E	DCF510P
PU1147E	DCF353P
PU1147E	DCF357P
PU1150E	DCF517P
PU1152E	DCF521P
PU1154E	DCF061P
PU1156E	DCF499P
PU1157E	DCF096P
PU1158E	DCF516P
PU1159E	DCF465P
PU1164E	DCF357P
PU1171E	DCF513P
PU1174E	DCF418P
PU1175E	DCF405P
PU1176E	DCF532P
PU1177E	DCF413P
PU1178E	DCF361P
PU1179E	DCF042P
PU1180E	DCF410P
PU1185E	DCF471P
PU1186E	DCF255P
PU1187E	DCF480P
PU1189E	DCF466P
PU1189E	DCF561P
PU1190E	DCF064P
PU1190E	DCF475P
PU1191E	DCF243P

ACDelco	DENSO
19372700	DCF382P
19372702	DCF383P
PU1001E	DCF446P

Cabin Air Filter

Cross Reference Chart - OE

ACDelco	DENSO
PU1193E	DCF306P
PU1194E	DCF488P
PU1196E	DCF473P
PU1198E	DCF242P
PU1200E	DCF560P
PU1202E	DCF506P
PU1203E	DCF512P
PU1204E	DCF382P
PU1205E	DCF563P
PU1206E	DCF375P
PU1207E	DCF408P
PU1208E	DCF302P
PU1209E	DCF467P
PU1212E	DCF564P
PU1213E	DCF485P
PU1215E	DCF486P
PU1216E	DCF566P
PU1217E	DCF567P
PU1218E	DCF467P
PU1219E	DCF568P
PU1221E	DCF509P
PU1223E	DCF245P
PU1224E	DCF454P
PU1225E	DCF377P
PU1226E	DCF475P
PU1229E	DCF330P
PU1231E	DCF571P
PU1232E	DCF285P
PU1233E	DCF284P
PU1236E	DCF460P
PU1237E	DCF526P
PU1238E	DCF466P
PU1239E	DCF479P
PU1240E	DCF572P
PU1242E	DCF371P
PU1245E	DCF263P
PU1253E	DCF580P
PUK1021E	DCF458K
PUK1034E	DCF002K
PUK1034E	DCF225K
PUK1035E	DCF068K
PUK1036E	DCF068K
PUK1038E	DCF071K
PUK1041E	DCF044K
PUK1044E	DCF054K
PUK1046E	DCF196K
PUK1050E	DCF252K
PUK1051E	DCF056K
PUK1052E	DCF223K
PUK1054E	DCF351K
PUK1060E	DCF152K
PUK1067E	DCF050K
PUK1074E	DCF094K
PUK1075E	DCF062K
PUK1080E	DCF450K
PUK1083E	DCF002K
PUK1084E	DCF052K
PUK1089E	DCF035K
PUK1146E	DCF199K
PUK1147E	DCF015K
PUK1148E	DCF239K
PUK1148E	DCF384K
PUK1149E	DCF090K
PUK1150E	DCF048K
PUK1151E	DCF105K
PUK1153E	DCF059K
PUK1154E	DCF063K
PUK1155E	DCF346K
PUK1156E	DCF072K
PUK1156E	DCF343K
PUK1157E	DCF347K
PUK1159E	DCF211K
PUK1162E	DCF106K

ACDelco	DENSO
PUK1163E	DCF234K
PUK1166E	DCF419K
PUK1169E	DCF122K
PUK1170E	DCF067K
PUK1171E	DCF450K
PUK1173E	DCF163K
PUK1174E	DCF168K
PUK1175E	DCF453K
PUK1176E	DCF170K
PUK1178E	DCF181K
PUK1181E	DCF332K
PUK1182E	DCF300K
PUK1184E	DCF340K
PUK1187E	DCF153K
PUK1239E	DCF073K

ALCO FILTER	DENSO
MS-6018	DCF018P
MS-6020	DCF500P
MS-6020C	DCF094K
MS-6025	DCF537P
MS-6031	DCF416P
MS-6100	DCF514P
MS-6101	DCF009P
MS-6102	DCF508P
MS-6103	DCF031P
MS-6105	DCF541P
MS-6109	DCF461P
MS-6109C	DCF002K
MS-6115	DCF400P
MS-6118	DCF508P
MS-6118C	DCF050K
MS-6120	DCF096P
MS-6122	DCF287P
MS-6123	DCF507P
MS-6133	DCF446P
MS-6141	DCF402P
MS-6141C	DCF015K
MS-6144	DCF075P
MS-6145	DCF536P
MS-6148	DCF474P
MS-6151	DCF502P
MS-6153	DCF109P
MS-6158	DCF270P
MS-6160	DCF482P
MS-6161	DCF476P
MS-6175	DCF190P
MS-6176	DCF493P
MS-6176C	DCF460K
MS-6179	DCF016P
MS-6179C	DCF062K
MS-6181C	DCF072K
MS-6181C	DCF343K
MS-6182C	DCF345K
MS-6183	DCF412P
MS-6188	DCF357P
MS-6190C	DCF152K
MS-6193	DCF262P
MS-6194	DCF550P
MS-6195	DCF159P
MS-6197	DCF141P
MS-6197	DCF142P
MS-6202	DCF463P
MS-6202C	DCF054K
MS-6203	DCF492P
MS-6204	DCF517P
MS-6206C	DCF188K
MS-6207	DCF517P
MS-6216	DCF462P
MS-6216C	DCF458K
MS-6223	DCF513P
MS-6224C	DCF223K
MS-6225	DCF475P

ALCO FILTER	DENSO
MS-6228	DCF187P
MS-6231	DCF540P
MS-6237C	DCF071K
MS-6238	DCF366P
MS-6239	DCF410P
MS-6240	DCF353P
MS-6241	DCF083P
MS-6241	DCF497P
MS-6242	DCF255P
MS-6245	DCF504P
MS-6246	DCF361P
MS-6247	DCF193P
MS-6248	DCF303P
MS-6249	DCF064P
MS-6249C	DCF065K
MS-6250	DCF144P
MS-6250C	DCF252K
MS-6253	DCF408P
MS-6255	DCF532P
MS-6258	DCF266P
MS-6259C	DCF105K
MS-6267	DCF469P
MS-6271	DCF413P
MS-6273	DCF466P
MS-6274	DCF449P
MS-6274C	DCF052K
MS-6275	DCF467P
MS-6277	DCF477P
MS-6277C	DCF234K
MS-6278	DCF510P
MS-6279	DCF480P
MS-6284C	DCF221K
MS-6288	DCF283P
MS-6292	DCF042P
MS-6294	DCF284P
MS-6295	DCF405P
MS-6295C	DCF346K
MS-6296	DCF061P
MS-6296C	DCF063K
MS-6299	DCF403P
MS-6299C	DCF419K
MS-6302	DCF499P
MS-6303	DCF465P
MS-6303C	DCF236K
MS-6304	DCF452P
MS-6304C	DCF453K
MS-6305	DCF096P
MS-6305C	DCF450K
MS-6307	DCF486P
MS-6308C	DCF181K
MS-6310	DCF506P
MS-6311	DCF516P
MS-6311C	DCF127K
MS-6313	DCF562P
MS-6314	DCF563P
MS-6315	DCF374P
MS-6316	DCF522P
MS-6316C	DCF122K
MS-6317	DCF375P
MS-6320	DCF242P
MS-6322C	DCF118K
MS-6323	DCF521P
MS-6323C	DCF172K
MS-6325	DCF473P
MS-6328	DCF245P
MS-6329	DCF454P
MS-6330C	DCF081K
MS-6331	DCF471P
MS-6331C	DCF106K
MS-6332	DCF418P
MS-6339	DCF488P
MS-6341	DCF309P
MS-6344C	DCF059K

ALCO FILTER	DENSO
MS-6345	DCF509P
MS-6347C	DCF163K
MS-6348	DCF263P
MS-6348	DCF577P
MS-6354C	DCF170K
MS-6359	DCF526P
MS-6360	DCF423P
MS-6364	DCF286P
MS-6365	DCF483P
MS-6366	DCF366P
MS-6368	DCF382P
MS-6368C	DCF385K
MS-6369	DCF571P
MS-6370	DCF560P
MS-6371	DCF371P
MS-6372	DCF377P
MS-6376	DCF467P
MS-6380	DCF485P
MS-6381C	DCF120K
MS-6386	DCF243P
MS-6388	DCF566P
MS-6390	DCF570P
MS-6391	DCF573P
MS-6395	DCF568P
MS-6398	DCF564P
MS-6400	DCF479P
MS-6401	DCF565P
MS-6410	DCF567P
MS-6411	DCF569P
MS-6418	DCF460P
MS-6419C	DCF160K
MS-6421	DCF572P
MS-6424	DCF268P
MS-6425	DCF574P
MS-6438	DCF576P
MS-6448	DCF583P
MS-6453	DCF582P
MS-6455C	DCF231K
MS-6457	DCF380P
MS-6460	DCF589P
MS-6461	DCF580P
MS-6462	DCF584P
MS-6471C	DCF162K
MS-6474C	DCF352K
MS-6477	DCF588P
MS-6482	DCF579P
MS-6483	DCF587P
MS-6488	DCF578P
MS-6490	DCF590P
MS-6492C	DCF161K
MS-6493C	DCF080K
MS-6495	DCF585P
MS-6506	DCF383P
MS-6507	DCF386P
MS-6508	DCF326P
MS-6510	DCF306P
MS-6801	DCF076P

AMC FILTER	DENSO
DC-7102	DCF242P
DC-7103	DCF076P
DC-7103	DCF078P
DC-7104	DCF075P
DC-7106	DCF243P
DC-7108	DCF245P
DC-7110	DCF564P
HC-8101	DCF255P
HC-8103	DCF109P
HC-8111	DCF466P
HC-8113	DCF512P
HC-8114	DCF561P
HC-8115	DCF466P
HC-8116	DCF473P

AMC FILTER	DENSO
HC-8118	DCF573P
HC-8120	DCF561P
HC-8201	DCF408P
HC-8202	DCF366P
HC-8203	DCF410P
HC-8205	DCF266P
HC-8210	DCF486P
HC-8212	DCF268P
HC-8215	DCF263P
HC-8216	DCF582P
HC-8217	DCF577P
HC-8222	DCF570P
HC-8238	DCF577P
KC-6102	DCF280P
KC-6103	DCF283P
KC-6103	DCF285P
KC-6104	DCF283P
KC-6105	DCF284P
KC-6108	DCF483P
KC-6109	DCF279P
KC-6111	DCF569P
KC-6119	DCF388P
MC-4001	DCF302P
MC-4006	DCF306P
MC-4009C	DCF053K
MC-4011	DCF423P
MC-4012	DCF309P
MC-4013	DCF303P
MC-4015C	DCF300K
MC-4016C	DCF181K
MC-4017C	DCF344K
MC-4018C	DCF336K
MC-5111	DCF295P
MC-5112	DCF480P
MC-5113	DCF563P
MC-5120	DCF480P
MC-5121	DCF563P
MC-5123	DCF578P
NC-2002	DCF467P
NC-2002C	DCF273K
NC-2006	DCF187P
NC-2007	DCF190P
NC-2013	DCF509P
NC-2014	DCF502P
NC-2015	DCF502P
NC-2016	DCF418P
NC-2018	DCF368P
NC-2025	DCF565P
NC-2028	DCF574P
NC-2040	DCF588P
NC-2042	DCF568P
NC-2047	DCF586P
NC-2048	DCF579P
SC-9501	DCF374P
SC-9503	DCF330P
SC-9504	DCF375P
SC-9505	DCF377P
SC-9506	DCF466P
SC-9509	DCF460P
SC-9510	DCF376P
SC-9513	DCF380P
SC-9606	DCF326P
TC-1002	DCF361P
TC-1003	DCF353P
TC-1003C	DCF239K
TC-1003C	DCF384K
TC-1006	DCF357P
TC-1006C	DCF239K
TC-1010	DCF383P
TC-1011	DCF469P
TC-1015	DCF353P
TC-1015	DCF354P
TC-1017	DCF562P

AMC FILTER	DENSO
TC-1018	DCF382P
TC-1025C	DCF385K
TC-1028C	DCF389K
TC-1031	DCF585P
TC-1036	DCF386P

ASHIKA	DENSO
21-BY-BY00	DCF096P
21-BY-BY00	DCF450K
21-CD-CD0	DCF486P
21-CH-CH0	DCF067K
21-CH-CH2	DCF009P
21-CH-CH2	DCF068K
21-CH-CH3	DCF120K
21-CH-CH4	DCF080K
21-CH-CH5	DCF069K
21-DC-DC02	DCF579P
21-DW-W0	DCF076P
21-DW-W0	DCF078P
21-DW-W1	DCF075P
21-DW-W10	DCF243P
21-DW-W11	DCF242P
21-DW-W12	DCF371P
21-DW-W13	DCF243P
21-DW-W14	DCF245P
21-DW-W15	DCF564P
21-H0-H011	DCF561P
21-H0-H012	DCF573P
21-H0-H013	DCF570P
21-H0-H03	DCF255P
21-H0-H04	DCF512P
21-H0-H09	DCF473P
21-HY-H03	DCF366P
21-HY-H05	DCF266P
21-HY-H08	DCF408P
21-HY-H11	DCF486P
21-HY-H28	DCF263P
21-HY-H28	DCF577P
21-HY-H29	DCF582P
21-JE-JE3	DCF584P
21-KI-K00	DCF280P
21-KI-K05	DCF279P
21-KI-K06	DCF410P
21-KI-K07	DCF283P
21-KI-K09	DCF284P
21-KI-K11	DCF268P
21-KI-K15	DCF285P
21-KI-K18	DCF483P
21-KI-K20	DCF569P
21-KI-KI23	DCF582P
21-LR-LR2	DCF411P
21-LR-LR3	DCF286P
21-LR-LR4	DCF127K
21-LR-LR4	DCF516P
21-MA-MA0	DCF457K
21-MA-MA10	DCF480P
21-MA-MA15	DCF578P
21-MA-MA5	DCF480P
21-MA-MA8	DCF563P
21-MI-MI1	DCF306P
21-MI-MI2	DCF303P
21-MI-MI3	DCF309P
21-MI-MI4	DCF053K
21-MI-MI5	DCF300K
21-MI-MI7	DCF273K
21-MI-MI7	DCF344K
21-MI-MI7	DCF467P
21-MI-MI8	DCF423P
21-NS-NS0	DCF190P
21-NS-NS10	DCF509P
21-NS-NS11	DCF418P
21-NS-NS12	DCF502P
21-NS-NS13	DCF565P

ASHIKA	DENSO
21-NS-NS15	DCF574P
21-NS-NS21	DCF568P
21-NS-NS22	DCF588P
21-NS-NS4	DCF467P
21-NS-NS7	DCF187P
21-SB-SB0	DCF590P
21-SB-SB2	DCF239K
21-SB-SB2	DCF353P
21-SB-SB5	DCF326P
21-SM-SM0	DCF345K
21-SM-SM1	DCF181K
21-SM-SM1	DCF305P
21-SZ-SZ10	DCF376P
21-SZ-SZ13	DCF380P
21-SZ-SZ1	DCF374P
21-SZ-SZ2	DCF230P
21-SZ-SZ2	DCF375P
21-SZ-SZ3	DCF526P
21-SZ-SZ4	DCF330P
21-SZ-SZ5	DCF227P
21-SZ-SZ5	DCF526P
21-SZ-SZ7	DCF377P
21-SZ-SZ8	DCF466P
21-SZ-SZ9	DCF460P
21-TY-TY1	DCF361P
21-TY-TY10	DCF562P
21-TY-TY12	DCF239K
21-TY-TY13	DCF382P
21-TY-TY15	DCF585P
21-TY-TY1DX	DCF361P
21-TY-TY2	DCF357P
21-TY-TY20	DCF386P
21-TY-TY20	DCF387K
21-TY-TY3	DCF354P
21-TY-TY5	DCF353P
21-TY-TY5	DCF354P
21-TY-TY7	DCF383P
21-TY-TY7	DCF469P
21-TY-TY8	DCF239K
21-TY-TY8	DCF353P
21-TY-TY8	DCF384K
21-TY-TY9	DCF382P
21-TY-TY9	DCF385K

ASHUKI	DENSO
0402-3202	DCF383P
0402-4010	DCF382P
0402-4010	DCF385K
T109-18	DCF384K
T109-80	DCF386P

BLUE PRINT	DENSO
ADA102501	DCF080K
ADA102502	DCF009P
ADA102502	DCF068K
ADA102503	DCF067K
ADA102505	DCF223K
ADA102509	DCF120K
ADA102515	DCF069K
ADA102524	DCF580P
ADB112504	DCF420K
ADB112505	DCF450K
ADB112506	DCF096P
ADB112508	DCF567P
ADB112511	DCF063K
ADB112514	DCF403P
ADB112514	DCF419K
ADB112517	DCF064P
ADB112517	DCF065K
ADB112517	DCF475P
ADB112519	DCF581P
ADC42239	DCF306P
ADC42242	DCF423P

BLUE PRINT	DENSO
ADC42243	DCF309P
ADC42502	DCF303P
ADC42503	DCF423P
ADC42504	DCF309P
ADC42505	DCF306P
ADC42507	DCF300K
ADC42508	DCF181K
ADC42508	DCF305P
ADC42509	DCF302P
ADC42510	DCF336K
ADC42511	DCF344K
ADC42511	DCF467P
ADC42514	DCF053K
ADF122501	DCF566P
ADF122505	DCF365K
ADF122506	DCF106K
ADF122510	DCF589P
ADF122513	DCF474P
ADF122515	DCF236K
ADF122520	DCF471P
ADF122521	DCF465P
ADF122522	DCF352K
ADF122523	DCF343K
ADG02501	DCF410P
ADG02504	DCF078P
ADG02505	DCF242P
ADG02508	DCF366P
ADG02509	DCF408P
ADG02512	DCF061P
ADG02513	DCF486P
ADG02514	DCF268P
ADG02516	DCF284P
ADG02518	DCF280P
ADG02519	DCF268P
ADG02519	DCF410P
ADG02520	DCF266P
ADG02521	DCF283P
ADG02523	DCF243P
ADG02529	DCF279P
ADG02533	DCF263P
ADG02536	DCF285P
ADG02537	DCF483P
ADG02545	DCF371P
ADG02549	DCF570P
ADG02550	DCF245P
ADG02551	DCF582P
ADG02555	DCF569P
ADG02557	DCF577P
ADG02561	DCF564P
ADG02562	DCF564P
ADG02565	DCF283P
ADG02574	DCF582P
ADG02594	DCF582P
ADG02595	DCF582P
ADH22501	DCF255P
ADH22505	DCF466P
ADH22507	DCF561P
ADH22510	DCF512P
ADH22513	DCF473P
ADH22514	DCF561P
ADH22515	DCF573P
ADH22516	DCF573P
ADJ132502	DCF127K
ADJ132503	DCF516P
ADJ132505	DCF286P
ADJ132509	DCF411P
ADJ132511	DCF118K
ADJ132513	DCF119K
ADJ132517	DCF517P
ADK82503	DCF375P
ADK82504	DCF377P
ADK82505	DCF374P
ADK82506	DCF227P

Cabin Air Filter

Cross Reference Chart - OE

BLUE PRINT	DENSO
ADK82506	DCF526P
ADK82507	DCF330P
ADK82508	DCF460P
ADK82511	DCF380P
ADK82513	DCF590P
ADK82514	DCF381P
ADL142501	DCF499P
ADL142503	DCF090K
ADL142503	DCF504P
ADL142505	DCF584P
ADL142507	DCF448K
ADL142508	DCF506P
ADL142509	DCF083P
ADL142509	DCF497P
ADL142510	DCF072K
ADL142511	DCF532P
ADL142514	DCF454P
ADL142518	DCF048K
ADM52501	DCF457K
ADM52508	DCF563P
ADM52509	DCF105K
ADM52513	DCF295P
ADM52519	DCF563P
ADM52520	DCF480P
ADM52530	DCF563P
ADM52531	DCF578P
ADN12504	DCF190P
ADN12505	DCF467P
ADN12509	DCF418P
ADN12510	DCF187P
ADN12511	DCF509P
ADN12516	DCF502P
ADN12517	DCF376P
ADN12521	DCF574P
ADN12526	DCF565P
ADN12539	DCF588P
ADP152502	DCF479P
ADP152503	DCF485P
ADP152505	DCF479P
ADP152506	DCF073K
ADP152508	DCF560P
ADP152510	DCF071K
ADP152513	DCF211K
ADP152519	DCF536P
ADP152520	DCF347K
ADP152521	DCF493P
ADP152522	DCF018P
ADP152523	DCF346K
ADP152523	DCF405P
ADP152525	DCF540P
ADR162502	DCF568P
ADR162503	DCF586P
ADR162507	DCF413P
ADR162508	DCF579P
ADR162513	DCF492P
ADR162519	DCF221K
ADS72506	DCF326P
ADT32502	DCF354P
ADT32504	DCF353P
ADT32505	DCF357P
ADT32508	DCF469P
ADT32509	DCF361P
ADT32511	DCF382P
ADT32512	DCF239K
ADT32512	DCF384K
ADT32514	DCF382P
ADT32514	DCF385K
ADT32517	DCF382P
ADT32519	DCF383P
ADT32522	DCF385K
ADT32526	DCF239K
ADT32543	DCF385K
ADT32544	DCF332K

BLUE PRINT	DENSO
ADT32549	DCF389K
ADT32550	DCF585P
ADT32551	DCF386P
ADT32552	DCF387K
ADT32554	DCF386P
ADT32555	DCF388P
ADU172503	DCF345K
ADU172504	DCF153K
ADU172505	DCF587P
ADU172506	DCF152K
ADU172507	DCF452P
ADU172507	DCF453K
ADU172508	DCF514P
ADU172509	DCF252K
ADU172510	DCF341K
ADU172510	DCF412P
ADU172513	DCF144P
ADU172513	DCF145P
ADU172514	DCF163K
ADU172515	DCF168K
ADU172519	DCF035K
ADU172520	DCF172K
ADU172521	DCF521P
ADU172522	DCF081K
ADV182501	DCF459K
ADV182502	DCF052K
ADV182503	DCF462P
ADV182504	DCF449P
ADV182507	DCF463P
ADV182508	DCF054K
ADV182509	DCF571P
ADV182511	DCF576P
ADV182512	DCF576P
ADV182514	DCF056K
ADV182515	DCF122K
ADV182516	DCF522P
ADV182517	DCF059K
ADV182518	DCF094K
ADV182518	DCF500P
ADV182519	DCF500P
ADV182520	DCF583P
ADV182521	DCF461P
ADV182522	DCF002K
ADV182522	DCF225K
ADV182523	DCF234K
ADV182524	DCF508P
ADV182526	DCF575P
ADV182527	DCF477P
ADV182528	DCF231K
ADW192503	DCF201K
ADW192504	DCF200K
ADW192505	DCF199K
ADW192506	DCF510P
ADW192507	DCF198K
ADW192508	DCF482P
ADW192510	DCF564P
ADW192514	DCF031P
ADZ92503	DCF476P
ADZ92507	DCF488P
DCF356P	DCF382P

BOSCH	DENSO
0 986 AF4 047	DCF385K
0 986 AF5 094	DCF385K
0 986 AF5 845	DCF385K
0 986 BF0 558	DCF385K
0 986 BF0 689	DCF387K
1 987 432 190	DCF382P
1 987 432 320	DCF384K
1 987 435 044	DCF382P
1 987 435 087	DCF388P
1 987 435 089	DCF383P
1 987 435 108	DCF386P

BOSCH	DENSO
1 987 435 557	DCF385K
1987431026	DCF109P
1987431031	DCF193P
1987431042	DCF536P
1987431051	DCF159P
1987431055	DCF255P
1987431059	DCF083P
1987431066	DCF227P
1987431066	DCF526P
1987431073	DCF517P
1987431074	DCF512P
1987431081	DCF144P
1987431082	DCF061P
1987431083	DCF540P
1987431091	DCF532P
1987431092	DCF480P
1987431097	DCF449P
1987431103	DCF064P
1987431105	DCF075P
1987431106	DCF499P
1987431107	DCF086P
1987431111	DCF510P
1987431113	DCF465P
1987431303	DCF044K
1987431307	DCF351K
1987431312	DCF225K
1987431317	DCF050K
1987431336	DCF062K
1987431357	DCF458K
1987431361	DCF402P
1987431364	DCF341K
1987431365	DCF090K
1987431366	DCF196K
1987431370	DCF152K
1987431378	DCF345K
1987431379	DCF071K
1987431382	DCF063K
1987431386	DCF048K
1987431387	DCF105K
1987431399	DCF347K
1987431411	DCF199K
1987431412	DCF211K
1987431413	DCF236K
1987431550	DCF410P
1987431551	DCF408P
1987431556	DCF283P
1987431561	DCF076P
1987431570	DCF266P
1987431571	DCF242P
1987431573	DCF280P
1987431952	DCF354P
1987431969	DCF354P
1987432001	DCF009P
1987432003	DCF507P
1987432004	DCF564P
1987432010	DCF541P
1987432012	DCF461P
1987432015	DCF031P
1987432017	DCF508P
1987432018	DCF096P
1987432020	DCF514P
1987432021	DCF018P
1987432028	DCF500P
1987432036	DCF016P
1987432037	DCF495P
1987432038	DCF482P
1987432039	DCF502P
1987432040	DCF476P
1987432043	DCF537P
1987432045	DCF474P
1987432048	DCF493P
1987432052	DCF550P
1987432055	DCF483P

BOSCH	DENSO
1987432056	DCF446P
1987432057	DCF462P
1987432058	DCF190P
1987432064	DCF494P
1987432065	DCF454P
1987432066	DCF526P
1987432068	DCF420K
1987432071	DCF463P
1987432072	DCF504P
1987432075	DCF467P
1987432076	DCF481P
1987432076	DCF486P
1987432078	DCF568P
1987432079	DCF470P
1987432080	DCF492P
1987432084	DCF239K
1987432085	DCF239K
1987432085	DCF353P
1987432089	DCF416P
1987432090	DCF270P
1987432091	DCF072K
1987432093	DCF413P
1987432094	DCF414P
1987432102	DCF403P
1987432103	DCF064P
1987432103	DCF065K
1987432103	DCF475P
1987432113	DCF465P
1987432114	DCF477P
1987432115	DCF466P
1987432116	DCF411P
1987432117	DCF457K
1987432122	DCF522P
1987432124	DCF096P
1987432132	DCF570P
1987432133	DCF506P
1987432134	DCF303P
1987432136	DCF560P
1987432137	DCF479P
1987432148	DCF376P
1987432156	DCF374P
1987432157	DCF302P
1987432158	DCF366P
1987432159	DCF361P
1987432163	DCF563P
1987432164	DCF284P
1987432166	DCF561P
1987432169	DCF286P
1987432170	DCF486P
1987432171	DCF245P
1987432172	DCF330P
1987432173	DCF466P
1987432175	DCF076P
1987432177	DCF561P
1987432188	DCF201K
1987432188	DCF488P
1987432189	DCF562P
1987432190	DCF382P
1987432195	DCF521P
1987432203	DCF473P
1987432204	DCF262P
1987432204	DCF263P
1987432207	DCF306P
1987432208	DCF418P
1987432214	DCF460P
1987432216	DCF467P
1987432221	DCF230P
1987432221	DCF375P
1987432222	DCF371P
1987432223	DCF243P
1987432224	DCF582P
1987432234	DCF573P
1987432235	DCF516P

Cabin Air Filter

Cross Reference Chart - OE

BOSCH	DENSO
1987432238	DCF509P
1987432246	DCF574P
1987432247	DCF565P
1987432250	DCF467P
1987432251	DCF572P
1987432253	DCF569P
1987432255	DCF210P
1987432257	DCF467P
1987432260	DCF279P
1987432263	DCF354P
1987432266	DCF466P
1987432272	DCF583P
1987432274	DCF589P
1987432296	DCF567P
1987432300	DCF002K
1987432301	DCF068K
1987432304	DCF564P
1987432308	DCF365K
1987432309	DCF163K
1987432320	DCF239K
1987432320	DCF384K
1987432324	DCF056K
1987432328	DCF094K
1987432337	DCF035K
1987432354	DCF513P
1987432361	DCF015K
1987432361	DCF402P
1987432364	DCF412P
1987432368	DCF420K
1987432371	DCF054K
1987432376	DCF223K
1987432377	DCF039K
1987432377	DCF450K
1987432377	DCF497P
1987432381	DCF252K
1987432397	DCF052K
1987432398	DCF346K
1987432400	DCF221K
1987432402	DCF419K
1987432406	DCF332K
1987432409	DCF106K
1987432410	DCF453K
1987432415	DCF365K
1987432416	DCF344K
1987432416	DCF467P
1987432422	DCF122K
1987432423	DCF059K
1987432424	DCF450K
1987432425	DCF340K
1987432426	DCF300K
1987432428	DCF118K
1987432431	DCF234K
1987432433	DCF448K
1987432434	DCF181K
1987432468	DCF354P
1987432482	DCF354P
1987432488	DCF201K
1987432495	DCF172K
1987432497	DCF067K
1987432498	DCF053K
1987432535	DCF127K
1987432536	DCF118K
1987432539	DCF471P
1987432540	DCF575P
1987432574	DCF589P
1987432809	DCF268P
1987435002	DCF576P
1987435003	DCF581P
1987435005	DCF580P
1987435006	DCF187P
1987435011	DCF579P
1987435016	DCF571P
1987435017	DCF584P

BOSCH	DENSO
1987435018	DCF471P
1987435019	DCF578P
1987435021	DCF575P
1987435031	DCF579P
1987435057	DCF588P
1987435058	DCF587P
1987435066	DCF585P
1987435071	DCF590P
1987435082	DCF586P
1987435097	DCF577P
1987435502	DCF576P
1987435508	DCF160K
1987435509	DCF119K
1987435515	DCF198K
1987435517	DCF467P
1987435519	DCF336K
1987435522	DCF073K
1987435550	DCF125K
1987435555	DCF072K
1988432084	DCF357P
1989432088	DCF469P

CHAMPION	DENSO
CCF0001	DCF461P
CCF0001C	DCF002K
CCF001C	DCF225K
CCF0003	DCF486P
CCF0007	DCF210P
CCF0007	DCF408P
CCF0011	DCF492P
CCF0012C	DCF221K
CCF0013	DCF476P
CCF0013C	DCF200K
CCF0015	DCF486P
CCF0015C	DCF223K
CCF0017	DCF466P
CCF0019	DCF268P
CCF0021	DCF477P
CCF0021C	DCF234K
CCF0023	DCF465P
CCF0023C	DCF236K
CCF0024	DCF474P
CCF0025	DCF242P
CCF0026	DCF243P
CCF0027	DCF255P
CCF0028	DCF540P
CCF0029C	DCF072K
CCF0029C	DCF343K
CCF0030	DCF266P
CCF0031	DCF270P
CCF0032	DCF280P
CCF0034	DCF284P
CCF0035	DCF502P
CCF0036	DCF287P
CCF0038C	DCF300K
CCF0045	DCF467P
CCF0046	DCF500P
CCF0046C	DCF094K
CCF0047	DCF405P
CCF0047C	DCF346K
CCF0048C	DCF347K
CCF0050	DCF353P
CCF0050C	DCF384K
CCF0051	DCF382P
CCF0051C	DCF385K
CCF0052	DCF469P
CCF0055	DCF361P
CCF0056	DCF366P
CCF0057	DCF402P
CCF0058	DCF509P
CCF0059	DCF400P
CCF0060	DCF413P
CCF0065	DCF075P

CHAMPION	DENSO
CCF0068	DCF016P
CCF0068C	DCF062K
CCF0070C	DCF056K
CCF0073	DCF507P
CCF0073C	DCF044K
CCF0075	DCF446P
CCF0077	DCF502P
CCF0079	DCF541P
CCF0081C	DCF035K
CCF0082	DCF493P
CCF0082C	DCF460K
CCF0093	DCF513P
CCF0094	DCF083P
CCF0094	DCF497P
CCF0094C	DCF450K
CCF0099	DCF418P
CCF0100	DCF499P
CCF0106	DCF410P
CCF0107	DCF144P
CCF0107C	DCF252K
CCF0109	DCF471P
CCF0109C	DCF106K
CCF0112C	DCF002K
CCF0115	DCF403P
CCF0116	DCF480P
CCF0118	DCF096P
CCF0118C	DCF450K
CCF0119	DCF488P
CCF0120	DCF560P
CCF0123	DCF357P
CCF0124	DCF463P
CCF0124C	DCF054K
CCF0125	DCF561P
CCF0126	DCF279P
CCF0129	DCF563P
CCF0130	DCF302P
CCF0131	DCF467P
CCF0132	DCF411P
CCF0134	DCF564P
CCF0137C	DCF073K
CCF0139	DCF485P
CCF0140	DCF565P
CCF0142	DCF466P
CCF0144C	DCF332K
CCF0147	DCF567P
CCF0151	DCF569P
CCF0156	DCF570P
CCF0157	DCF514P
CCF0158C	DCF080K
CCF0159	DCF454P
CCF0160	DCF285P
CCF0161	DCF377P
CCF0162	DCF475P
CCF0162C	DCF340K
CCF0164	DCF371P
CCF0168C	DCF152K
CCF0169C	DCF336K
CCF0172	DCF483P
CCF0173	DCF571P
CCF0178	DCF285P
CCF0179	DCF096P
CCF0179	DCF517P
CCF0180C	DCF081K
CCF0182	DCF460P
CCF0184	DCF516P
CCF0184C	DCF127K
CCF0185	DCF573P
CCF0186	DCF263P
CCF0187	DCF268P
CCF0192	DCF141P
CCF0196	DCF159P
CCF0197C	DCF059K
CCF0198	DCF306P

CHAMPION	DENSO
CCF0199	DCF187P
CCF0201	DCF009P
CCF0201C	DCF068K
CCF0203C	DCF065K
CCF0208C	DCF196K
CCF0209	DCF508P
CCF0209C	DCF050K
CCF0216	DCF262P
CCF0223	DCF330P
CCF0225	DCF303P
CCF0227C	DCF071K
CCF0238C	DCF457K
CCF0245	DCF416P
CCF0257	DCF076P
CCF0274C	DCF162K
CCF0293	DCF506P
CCF0294C	DCF345K
CCF0302C	DCF048K
CCF0303	DCF449P
CCF0303C	DCF052K
CCF0311	DCF061P
CCF0313C	DCF067K
CCF0315	DCF536P
CCF0320	DCF462P
CCF0320C	DCF458K
CCF0323C	DCF090K
CCF0327	DCF517P
CCF0328C	DCF105K
CCF0331	DCF482P
CCF0335	DCF109P
CCF0337	DCF473P
CCF0338	DCF512P
CCF0348C	DCF453K
CCF0349C	DCF163K
CCF0350C	DCF168K
CCF0351	DCF521P
CCF0352C	DCF181K
CCF0355	DCF190P
CCF0357	DCF510P
CCF0357C	DCF199K
CCF0360	DCF031P
CCF0402	DCF550P
CCF0427	DCF562P
CCF0433	DCF410P
CCF0435	DCF283P
CCF0436	DCF572P
CCF0440	DCF581P
CCF0441	DCF245P
CCF0448	DCF582P
CCF0458	DCF568P
CCF0464	DCF589P
CCF0465	DCF576P
CCF0467C	DCF170K
CCF0468	DCF583P
CCF0471	DCF574P
CCF0473	DCF580P
CCF0474	DCF584P
CCF0475	DCF579P
CCF0476	DCF588P
CCF0477	DCF590P

CLEAN FILTERS	DENSO
NC2000	DCF508P
NC2001	DCF541P
NC2002	DCF031P
NC2007	DCF096P
NC2009CA	DCF056K
NC2010	DCF018P
NC2011	DCF042P
NC2011	DCF507P
NC2012	DCF461P
NC2019	DCF500P
NC2020	DCF109P

Cabin Air Filter

Cross Reference Chart - OE

CLEAN FILTERS	DENSO
NC2021	DCF536P
NC2023	DCF482P
NC2023CA	DCF198K
NC2024	DCF502P
NC2025	DCF075P
NC2026	DCF076P
NC2026	DCF078P
NC2027	DCF287P
NC2030	DCF268P
NC2032	DCF474P
NC2034	DCF270P
NC2035	DCF476P
NC2035CA	DCF200K
NC2036	DCF083P
NC2037	DCF514P
NC2038	DCF537P
NC2042	DCF493P
NC2042CA	DCF460K
NC2047	DCF462P
NC2048CA	DCF450K
NC2052	DCF513P
NC2053	DCF227P
NC2053	DCF526P
NC2054	DCF357P
NC2062	DCF486P
NC2063	DCF492P
NC2066	DCF009P
NC2067CA	DCF035K
NC2068CA	DCF345K
NC2069CA	DCF015K
NC2070	DCF402P
NC2072CA	DCF044K
NC2074CA	DCF002K
NC2074CA	DCF225K
NC2075CA	DCF050K
NC2076CA	DCF094K
NC2077CA	DCF068K
NC2078CA	DCF196K
NC2082CA	DCF002K
NC2084	DCF016P
NC2085	DCF446P
NC2088CA	DCF062K
NC2092	DCF190P
NC2097CA	DCF458K
NC2099	DCF255P
NC2102CA	DCF071K
NC2104	DCF504P
NC2106	DCF463P
NC2107	DCF517P
NC2108CA	DCF054K
NC2109CA	DCF223K
NC2110	DCF061P
NC2111CA	DCF063K
NC2112	DCF532P
NC2113CA	DCF105K
NC2114	DCF295P
NC2115CA	DCF152K
NC2118CA	DCF221K
NC2120	DCF383P
NC2120	DCF469P
NC2121	DCF361P
NC2126	DCF510P
NC2127CA	DCF199K
NC2128CA	DCF072K
NC2128CA	DCF343K
NC2129CA	DCF052K
NC2131CA	DCF181K
NC2132	DCF449P
NC2133	DCF413P
NC2134	DCF499P
NC2135	DCF540P
NC2136	DCF471P
NC2137CA	DCF106K

CLEAN FILTERS	DENSO
NC2138	DCF403P
NC2138CA	DCF419K
NC2140CA	DCF053K
NC2141	DCF418P
NC2145CA	DCF234K
NC2146	DCF405P
NC2146CA	DCF346K
NC2148CA	DCF044K
NC2149CA	DCF172K
NC2151	DCF353P
NC2152	DCF477P
NC2153	DCF521P
NC2154CA	DCF211K
NC2186	DCF416P
NC2189	DCF488P
NC2189CA	DCF201K
NC2191	DCF452P
NC2191CA	DCF453K
NC2192	DCF522P
NC2192CA	DCF122K
NC2193	DCF560P
NC2196	DCF410P
NC2197	DCF366P
NC2198	DCF562P
NC2199	DCF466P
NC2200	DCF480P
NC2204CA	DCF236K
NC2205	DCF473P
NC2206	DCF561P
NC2207	DCF512P
NC2208	DCF466P
NC2302	DCF563P
NC2305	DCF465P
NC2311CA	DCF340K
NC2312CA	DCF332K
NC2314	DCF096P
NC2314CA	DCF450K
NC2315	DCF479P
NC2315CA	DCF073K
NC2316	DCF454P
NC2317	DCF159P
NC2320CA	DCF252K
NC2321	DCF567P
NC2322	DCF412P
NC2324CA	DCF067K
NC2325CA	DCF347K
NC2326CA	DCF059K
NC2328CA	DCF170K
NC2329CA	DCF127K
NC2331	DCF467P
NC2333	DCF486P
NC2336	DCF193P
NC2337	DCF475P
NC2340	DCF509P
NC2341	DCF571P
NC2342	DCF284P
NC2343	DCF570P
NC2345CA	DCF081K
NC2347	DCF572P
NC2348	DCF485P
NC2350	DCF467P
NC2351CA	DCF163K
NC2353CA	DCF365K
NC2354	DCF566P
NC2355	DCF242P
NC2356	DCF266P
NC2357	DCF573P
NC2358	DCF382P
NC2358	DCF385K
NC2358CA	DCF385K
NC2360	DCF460P
NC2361	DCF564P
NC2364	DCF280P

CLEAN FILTERS	DENSO
NC2365	DCF374P
NC2366	DCF245P
NC2367	DCF582P
NC2372CA	DCF161K
NC2373	DCF303P
NC2375	DCF483P
NC2376	DCF568P
NC2378	DCF371P
NC2381	DCF569P
NC2383	DCF283P
NC2385	DCF580P
NC2386	DCF576P
NC2387	DCF581P
NC2388	DCF377P
NC2389	DCF584P
NC2391	DCF263P
NC2391	DCF577P
NC2395	DCF579P
NC2397	DCF565P

COMLINE	DENSO
EA167	DCF514P
EA199	DCF461P
EA476	DCF090K
EA476	DCF504P
EKF101	DCF560P
EKF102	DCF504P
EKF102A	DCF090K
EKF103	DCF083P
EKF103	DCF497P
EKF103A	DCF450K
EKF104	DCF510P
EKF104A	DCF199K
EKF105	DCF042P
EKF106	DCF571P
EKF107	DCF096P
EKF107A	DCF450K
EKF108	DCF305P
EKF108A	DCF181K
EKF109A	DCF211K
EKF110A	DCF015K
EKF112	DCF461P
EKF112A	DCF002K
EKF112A	DCF225K
EKF113	DCF474P
EKF115	DCF493P
EKF115A	DCF460K
EKF116	DCF486P
EKF116A	DCF223K
EKF117A	DCF071K
EKF118	DCF449P
EKF118A	DCF052K
EKF119	DCF476P
EKF119A	DCF200K
EKF120	DCF042P
EKF120	DCF507P
EKF120A	DCF044K
EKF121A	DCF105K
EKF122	DCF462P
EKF122A	DCF458K
EKF123	DCF482P
EKF123A	DCF198K
EKF124	DCF502P
EKF125	DCF508P
EKF125A	DCF050K
EKF126	DCF357P
EKF127A	DCF002K
EKF128	DCF083P
EKF129	DCF096P
EKF129	DCF517P
EKF130	DCF541P
EKF131	DCF500P
EKF131A	DCF094K

COMLINE	DENSO
EKF132A	DCF072K
EKF132A	DCF343K
EKF134	DCF502P
EKF135A	DCF162K
EKF136	DCF018P
EKF137	DCF488P
EKF137A	DCF201K
EKF139	DCF144P
EKF139A	DCF252K
EKF142	DCF031P
EKF143A	DCF196K
EKF145A	DCF351K
EKF149	DCF109P
EKF151A	DCF365K
EKF153	DCF411P
EKF154	DCF405P
EKF154A	DCF346K
EKF155	DCF517P
EKF156	DCF418P
EKF158	DCF403P
EKF158A	DCF419K
EKF159	DCF499P
EKF161	DCF471P
EKF161A	DCF106K
EKF162	DCF230P
EKF162	DCF375P
EKF163	DCF477P
EKF163A	DCF234K
EKF164	DCF522P
EKF164A	DCF122K
EKF167	DCF536P
EKF170	DCF479P
EKF170A	DCF073K
EKF172	DCF454P
EKF174A	DCF059K
EKF175A	DCF081K
EKF177A	DCF048K
EKF178A	DCF332K
EKF179A	DCF345K
EKF180	DCF567P
EKF181	DCF361P
EKF182	DCF446P
EKF184	DCF284P
EKF185	DCF382P
EKF185	DCF384K
EKF185A	DCF385K
EKF187	DCF469P
EKF188	DCF480P
EKF189	DCF353P
EKF190	DCF377P
EKF191	DCF509P
EKF192	DCF492P
EKF193	DCF540P
EKF194	DCF326P
EKF194	DCF467P
EKF195	DCF303P
EKF196	DCF413P
EKF197	DCF009P
EKF197A	DCF068K
EKF198	DCF485P
EKF199	DCF562P
EKF200	DCF227P
EKF200	DCF526P
EKF201	DCF512P
EKF202	DCF242P
EKF203	DCF263P
EKF204	DCF486P
EKF205	DCF075P
EKF208	DCF366P
EKF209	DCF561P
EKF212	DCF227P
EKF212	DCF526P
EKF213	DCF270P

Cabin Air Filter

Cross Reference Chart - OE

COMLINE	DENSO
EKF214	DCF465P
EKF214A	DCF236K
EKF215	DCF473P
EKF216	DCF266P
EKF219	DCF190P
EKF220	DCF371P
EKF222	DCF210P
EKF222	DCF408P
EKF224	DCF280P
EKF225	DCF466P
EKF226A	DCF163K
EKF227	DCF410P
EKF229	DCF513P
EKF230	DCF416P
EKF231	DCF514P
EKF232	DCF287P
EKF234	DCF255P
EKF236	DCF400P
EKF237	DCF463P
EKF237A	DCF054K
EKF241A	DCF056K
EKF244A	DCF152K
EKF246A	DCF035K
EKF247A	DCF221K
EKF248	DCF537P
EKF250	DCF452P
EKF250A	DCF453K
EKF251	DCF532P
EKF251A	DCF072K
EKF252	DCF061P
EKF252A	DCF063K
EKF253A	DCF347K
EKF254	DCF475P
EKF254A	DCF340K
EKF255	DCF016P
EKF255A	DCF062K
EKF256	DCF243P
EKF257	DCF466P
EKF261	DCF582P
EKF262	DCF483P
EKF263	DCF283P
EKF264	DCF467P
EKF264A	DCF344K
EKF265A	DCF053K
EKF265A	DCF336K
EKF266	DCF330P
EKF267	DCF563P
EKF270-2	DCF568P
EKF272	DCF245P
EKF273	DCF566P
EKF275	DCF353P
EKF279	DCF521P
EKF279A	DCF172K
EKF280A	DCF352K
EKF285	DCF461P
EKF288	DCF064P
EKF288	DCF475P
EKF288A	DCF065K
EKF289A	DCF420K
EKF291A	DCF067K
EKF293	DCF302P
EKF294A	DCF231K
EKF295	DCF564P
EKF296	DCF460P
EKF298A	DCF160K
EKF299A	DCF170K
EKF300A	DCF168K
EKF301	DCF569P
EKF302	DCF376P
EKF303	DCF268P
EKF304	DCF586P
EKF305	DCF565P

COMLINE	DENSO
EKF306	DCF573P
EKF308	DCF570P
EKF312	DCF383P
EKF317	DCF583P
EKF318A	DCF120K
EKF321	DCF572P
EKF323	DCF581P
EKF324	DCF582P
EKF328	DCF575P
EKF331	DCF589P
EKF332	DCF576P
EKF342	DCF516P
EKF343	DCF584P
EKF346	DCF306P
EKF349A	DCF300K
EKF351A	DCF069K
EKF352A	DCF118K
EKF353A	DCF080K
EKF355-2	DCF279P
EKF356-2	DCF423P
EKF360A	DCF239K
EKF360A	DCF384K
EKF362A	DCF346K
EKF364	DCF516P
EKF366	DCF574P
EKF372	DCF581P
EKF373	DCF507P
EKF375	DCF471P
EKF380	DCF579P
EKF382	DCF580P
EKF383A	DCF153K
EKF385	DCF578P
EKF386	DCF588P
EKF388A	DCF053K
EKF394	DCF145P
EKF395A	DCF053K
EKF400	DCF587P
EKF404	DCF585P
EKF406	DCF590P
EKF416	DCF388P
EKF422	DCF386P
EKF422A	DCF387K

COOPERSFIAAM FILTERS	DENSO
PC8002	DCF541P
PC8003	DCF018P
PC8004	DCF508P
PC8005	DCF461P
PC8006	DCF517P
PC8007	DCF031P
PC8016	DCF009P
PC8017	DCF109P
PC8024	DCF500P
PC8033	DCF514P
PC8035	DCF495P
PC8038	DCF270P
PC8043	DCF474P
PC8044	DCF083P
PC8046	DCF482P
PC8047	DCF476P
PC8051	DCF536P
PC8052	DCF550P
PC8053	DCF016P
PC8053	DCF062K
PC8058	DCF537P
PC8059	DCF502P
PC8060	DCF493P
PC8071	DCF050K
PC8076	DCF540P
PC8077	DCF576P
PC8079	DCF227P
PC8079	DCF526P
PC8084	DCF492P

COOPERSFIAAM FILTERS	DENSO
PC8085	DCF494P
PC8087	DCF075P
PC8088	DCF470P
PC8089	DCF306P
PC8093	DCF504P
PC8094	DCF268P
PC8097	DCF481P
PC8107	DCF446P
PC8108	DCF532P
PC8109	DCF071K
PC8110	DCF405P
PC8111	DCF413P
PC8117	DCF463P
PC8127	DCF286P
PC8141	DCF410P
PC8144	DCF384K
PC8148	DCF086P
PC8152	DCF389K
PC8152	DCF467P
PC8154	DCF418P
PC8158	DCF477P
PC8164	DCF414P
PC8166	DCF561P
PC8185	DCF383P
PC8186	DCF382P
PC8186	DCF385K
PC8188-2	DCF563P
PC8195	DCF382P
PC8197	DCF566P
PC8209	DCF571P
PC8217-2	DCF568P
PC8224	DCF562P
PC8241-2	DCF560P
PC8253	DCF586P
PC8255	DCF564P
PC8263	DCF567P
PC8264	DCF565P
PC8269-2	DCF570P
PC8290	DCF572P
PC8296	DCF573P
PC8298	DCF574P
PC8329	DCF582P
PC8330	DCF577P
PC8339	DCF583P
PC8340	DCF580P
PC8342	DCF581P
PC8346	DCF589P
PC8365	DCF584P
PC8374	DCF579P
PC8379	DCF587P
PC8397	DCF578P
PC8418	DCF588P
PC8420	DCF386P
PC8420	DCF387K
PC8420	DCF590P
PC8453	DCF585P
PC8488	DCF388P
PC8495	DCF577P
PCK8045	DCF002K
PCK8054-2	DCF015K
PCK8062	DCF056K
PCK8065	DCF068K
PCK8066	DCF094K
PCK8068	DCF044K
PCK8068	DCF507P
PCK8072	DCF196K
PCK8090	DCF048K
PCK8092	DCF458K
PCK8093	DCF090K
PCK8095	DCF345K
PCK8097	DCF223K
PCK8100	DCF039K

COOPERSFIAAM FILTERS	DENSO
PCK8100	DCF497P
PCK8103	DCF054K
PCK8110	DCF346K
PCK8137	DCF252K
PCK8168-2	DCF419K
PCK8186	DCF385K
PCK8193	DCF332K
PCK8204-2	DCF073K
PCK8264	DCF565P
PCK8420	DCF387K

CORTECO	DENSO
21651182	DCF541P
21651184	DCF031P
21651195	DCF514P
21651196	DCF009P
21651199	DCF159P
21651292	DCF035K
21651293	DCF493P
21651294	DCF341K
21651296	DCF090K
21651882	DCF015K
21651887	DCF141P
21651890	DCF508P
21651895	DCF500P
21651897	DCF402P
21651899	DCF018P
21651901	DCF507P
21651912	DCF461P
21651952	DCF044K
21651955	DCF225K
21651956	DCF050K
21651957	DCF056K
21651960	DCF094K
21651961	DCF068K
21651967	DCF002K
21651969	DCF016P
21651970	DCF042P
21651972	DCF109P
21651974	DCF142P
21651976	DCF537P
21651979	DCF476P
21651980	DCF482P
21651981	DCF193P
21651982	DCF550P
21651983	DCF502P
21651984	DCF270P
21651987	DCF446P
21651994	DCF536P
21651995	DCF474P
21652308	DCF083P
21652317	DCF494P
21652336	DCF062K
21652338	DCF075P
21652340	DCF076P
21652341	DCF078P
21652350	DCF227P
21652350	DCF526P
21652352	DCF048K
21652353	DCF196K
21652356	DCF462P
21652357	DCF458K
21652359	DCF255P
21652538	DCF039K
21652540	DCF071K
21652541	DCF351K
21652543	DCF513P
21652544	DCF504P
21652546	DCF512P
21652548	DCF470P
21652550	DCF492P
21652551	DCF357P
21652551	DCF383P

Cabin Air Filter

Cross Reference Chart - OE

CORTECO	DENSO
21652688	DCF495P
21652689	DCF463P
21652694	DCF125K
21652709	DCF517P
21652713	DCF054K
21652714	DCF481P
21652715	DCF223K
21652812	DCF160K
21652848	DCF064P
21652850	DCF061P
21652851	DCF065K
21652852	DCF420K
21652853	DCF063K
21652854	DCF067K
21652855	DCF069K
21652856	DCF210P
21652856	DCF532P
21652857	DCF478P
21652858	DCF105K
21652859	DCF118K
21652861	DCF152K
21652862	DCF153K
21652863	DCF144P
21652864	DCF145P
21652865	DCF252K
21652867	DCF303P
21652868	DCF306P
21652872	DCF221K
21652874	DCF469P
21652897	DCF361P
21652898	DCF059K
21652899	DCF086P
21652916	DCF340K
21652994	DCF510P
21652995	DCF199K
21652996	DCF072K
21652996	DCF343K
21653008	DCF052K
21653009	DCF172K
21653010	DCF164K
21653013	DCF181K
21653014	DCF345K
21653015	DCF234K
21653020	DCF477P
21653023	DCF400P
21653024	DCF449P
21653025	DCF521P
21653026	DCF499P
21653027	DCF497P
21653028	DCF540P
21653029	DCF412P
21653031	DCF231K
21653034	DCF471P
21653035	DCF106K
21653063	DCF403P
21653064	DCF419K
21653066	DCF122K
21653067	DCF522P
21653068	DCF460K
21653071	DCF413P
21653102	DCF211K
21653141	DCF405P
21653142	DCF346K
21653143	DCF453K
21653144	DCF452P
21653145	DCF480P
21653149	DCF347K
49370856	DCF590P
49387664	DCF388P
49387665	DCF387K
49408484	DCF382P
80000021	DCF200K
80000060	DCF411P

CORTECO	DENSO
80000061	DCF465P
80000062	DCF236K
80000063	DCF096P
80000064	DCF092K
80000064	DCF450K
80000065	DCF475P
80000066	DCF286P
80000067	DCF188K
80000068	DCF336K
80000069	DCF352K
80000071	DCF170K
80000072	DCF418P
80000080	DCF414P
80000083	DCF366P
80000113	DCF198K
80000155	DCF242P
80000157	DCF408P
80000158	DCF410P
80000162	DCF354P
80000330	DCF561P
80000331	DCF305P
80000345	DCF506P
80000346	DCF448K
80000360	DCF516P
80000361	DCF127K
80000403	DCF457K
80000405	DCF563P
80000408	DCF080K
80000537	DCF280P
80000538	DCF168K
80000541	DCF488P
80000546	DCF268P
80000548	DCF279P
80000594	DCF287P
80000603	DCF466P
80000604	DCF382P
80000605	DCF382P
80000606	DCF119K
80000610	DCF190P
80000613	DCF219P
80000614	DCF511P
80000615	DCF073K
80000616	DCF081K
80000620	DCF473P
80000634	DCF284P
80000643	DCF423P
80000647	DCF163K
80000648	DCF300K
80000650	DCF266P
80000652	DCF486P
80000654	DCF283P
80000656	DCF285P
80000657	DCF230P
80000662	DCF562P
80000666	DCF560P
80000669	DCF135K
80000712	DCF566P
80000740	DCF567P
80000746	DCF273K
80000777	DCF201K
80000804	DCF243P
80000813	DCF262P
80000813	DCF263P
80000813	DCF577P
80000815	DCF454P
80000824	DCF309P
80000825	DCF302P
80000839	DCF479P
80000853	DCF467P
80000854	DCF344K
80000866	DCF332K
80000869	DCF245P
80000871	DCF483P

CORTECO	DENSO
80000874	DCF509P
80000875	DCF370K
80000877	DCF371P
80000879	DCF571P
80000915	DCF368P
80001024	DCF187P
80001027	DCF485P
80001036	DCF460P
80001128	DCF489P
80001129	DCF365K
80001172	DCF330P
80001183	DCF573P
80001185	DCF564P
80001190	DCF120K
80001214	DCF582P
80001448	DCF570P
80001452	DCF383P
80001453	DCF383P
80001454	DCF569P
80001456	DCF568P
80001760	DCF565P
80001780	DCF574P
80001783	DCF576P
80001789	DCF380P
80004353	DCF581P
80004355	DCF583P
80004407	DCF580P
80004514	DCF575P
80004550	DCF587P
80004567	DCF578P
80004572	DCF584P
80004638	DCF579P
80004673	DCF589P
80005173	DCF588P
80005194	DCF585P
CP1179	DCF561P
CP1204	DCF563P
CP1259	DCF562P
CP1260	DCF560P
CP1264	DCF566P
CP1265	DCF567P
CP1277	DCF577P
CP1309	DCF571P
CP1334	DCF573P
CP1335	DCF564P
CP1344	DCF582P
CP1366	DCF570P
CP1369	DCF569P
CP1370	DCF568P
CP1418	DCF565P
CP1436	DCF576P
CP1437	DCF574P
CP1445	DCF581P
CP1447	DCF583P
CP1451	DCF580P
CP1455	DCF575P
CP1456	DCF587P
CP1461	DCF578P
CP1462	DCF584P
CP1463	DCF589P
CP1465	DCF579P
CP1485	DCF588P
CP1489	DCF585P
CP1530	DCF590P

DELPHI	DENSO
KF10014	DCF584P
KF10019	DCF581P
KF10020	DCF471P
KF10021	DCF564P
KF10022	DCF587P
KF10023	DCF575P
KF10186C	DCF384K

DELPHI	DENSO
TSP0325003	DCF508P
TSP0325003C	DCF050K
TSP0325004	DCF461P
TSP0325004C	DCF002K
TSP0325004C	DCF225K
TSP0325007	DCF018P
TSP0325009	DCF507P
TSP0325009C	DCF044K
TSP0325011	DCF096P
TSP0325011	DCF517P
TSP0325015	DCF541P
TSP0325016	DCF031P
TSP0325019C	DCF351K
TSP0325022	DCF287P
TSP0325024	DCF268P
TSP0325024	DCF287P
TSP0325028	DCF476P
TSP0325028C	DCF200K
TSP0325029	DCF500P
TSP0325029C	DCF094K
TSP0325031	DCF270P
TSP0325033	DCF109P
TSP0325034	DCF502P
TSP0325035	DCF416P
TSP0325038	DCF402P
TSP0325038C	DCF015K
TSP0325039	DCF056K
TSP0325042	DCF536P
TSP0325043	DCF086P
TSP0325044	DCF083P
TSP0325047	DCF514P
TSP0325048	DCF474P
TSP0325051	DCF482P
TSP0325051C	DCF198K
TSP0325052	DCF075P
TSP0325061	DCF495P
TSP0325061C	DCF035K
TSP0325062	DCF493P
TSP0325062C	DCF460K
TSP0325065	DCF400P
TSP0325072	DCF190P
TSP0325077	DCF537P
TSP0325080C	DCF345K
TSP0325083C	DCF152K
TSP0325085	DCF513P
TSP0325088	DCF072K
TSP0325088C	DCF343K
TSP0325098	DCF550P
TSP0325102	DCF227P
TSP0325102	DCF526P
TSP0325107	DCF009P
TSP0325107C	DCF068K
TSP0325110	DCF048K
TSP0325111	DCF462P
TSP0325111C	DCF458K
TSP0325112	DCF054K
TSP0325112	DCF463P
TSP0325113	DCF540P
TSP0325116	DCF039K
TSP0325116	DCF083P
TSP0325116	DCF497P
TSP0325116C	DCF450K
TSP0325122	DCF481P
TSP0325123	DCF470P
TSP0325123C	DCF071K
TSP0325124	DCF492P
TSP0325129	DCF494P
TSP0325133	DCF067K
TSP0325141	DCF512P
TSP0325148	DCF469P
TSP0325151	DCF446P
TSP0325152	DCF504P
TSP0325152C	DCF090K

Cabin Air Filter

Cross Reference Chart - OE

DELPHI	DENSO
TSP0325153	DCF561P
TSP0325154	DCF042P
TSP0325155	DCF016P
TSP0325155C	DCF062K
TSP0325159	DCF061P
TSP0325159C	DCF063K
TSP0325161	DCF475P
TSP0325161C	DCF340K
TSP0325162	DCF532P
TSP0325163	DCF499P
TSP0325167	DCF411P
TSP0325168	DCF286P
TSP0325171	DCF510P
TSP0325171C	DCF199K
TSP0325172	DCF221K
TSP0325173	DCF357P
TSP0325174	DCF052K
TSP0325174	DCF449P
TSP0325175	DCF353P
TSP0325176	DCF480P
TSP0325182	DCF284P
TSP0325183C	DCF211K
TSP0325184	DCF096P
TSP0325184C	DCF450K
TSP0325185	DCF305P
TSP0325185C	DCF181K
TSP0325186	DCF452P
TSP0325186C	DCF453K
TSP0325188	DCF522P
TSP0325189C	DCF200K
TSP0325191	DCF521P
TSP0325193	DCF418P
TSP0325194	DCF413P
TSP0325194C	DCF413P
TSP0325195	DCF414P
TSP0325195C	DCF414P
TSP0325196	DCF412P
TSP0325198C	DCF170K
TSP0325199C	DCF163K
TSP0325202	DCF563P
TSP0325203	DCF279P
TSP0325204	DCF473P
TSP0325205	DCF488P
TSP0325205C	DCF201K
TSP0325206	DCF562P
TSP0325207	DCF506P
TSP0325207C	DCF448K
TSP0325208	DCF144P
TSP0325208C	DCF252K
TSP0325209	DCF242P
TSP0325211	DCF366P
TSP0325212	DCF403P
TSP0325212C	DCF419K
TSP0325213	DCF405P
TSP0325213C	DCF346K
TSP0325214	DCF255P
TSP0325218	DCF466P
TSP0325220	DCF266P
TSP0325221	DCF483P
TSP0325222	DCF486P
TSP0325223	DCF410P
TSP0325223C	DCF410P
TSP0325225	DCF516P
TSP0325225C	DCF127K
TSP0325226	DCF566P
TSP0325227	DCF509P
TSP0325228	DCF467P
TSP0325229	DCF560P
TSP0325231	DCF377P
TSP0325232	DCF382P
TSP0325232	DCF384K
TSP0325232C	DCF239K
TSP0325232C	DCF382P

DELPHI	DENSO
TSP0325232C	DCF384K
TSP0325238	DCF245P
TSP0325239	DCF571P
TSP0325240	DCF477P
TSP0325240C	DCF234K
TSP0325244	DCF454P
TSP0325246	DCF479P
TSP0325246C	DCF073K
TSP0325250	DCF263P
TSP0325259C	DCF081K
TSP0325260	DCF567P
TSP0325263	DCF371P
TSP0325264C	DCF347K
TSP0325295C	DCF090K
TSP0325296	DCF486P
TSP0325296C	DCF090K
TSP0325296C	DCF223K
TSP0325297	DCF480P
TSP0325297C	DCF105K
TSP0325298C	DCF236K
TSP0325299	DCF466P
TSP0325305	DCF465P
TSP0325305	DCF471P
TSP0325305C	DCF106K
TSP0325310C	DCF365K
TSP0325312	DCF460P
TSP0325313	DCF568P
TSP0325317	DCF570P
TSP0325318	DCF485P
TSP0325319	DCF573P
TSP0325325	DCF376P
TSP0325326	DCF243P
TSP0325333	DCF565P
TSP0325334	DCF574P
TSP0325339	DCF576P
TSP0325342	DCF064P
TSP0325342C	DCF065K
TSP0325344	DCF580P
TSP0325345	DCF569P
TSP0325347	DCF579P

DENSO	DENSO
DCF113P	DCF512P
DCF121P	DCF522P
DCF207P	DCF532P
DCF355P	DCF383P
DCF356P	DCF382P
DCF359K	DCF384K

FEBI BILSTEIN	DENSO
09409	DCF500P
09410	DCF096P
09429	DCF541P
09430	DCF031P
09437	DCF009P
09438	DCF009P
09439	DCF514P
09445	DCF159P
09446	DCF461P
09447	DCF508P
09450	DCF400P
09485	DCF141P
100381	DCF584P
11104	DCF537P
11233	DCF476P
11235	DCF482P
11236	DCF198K
11265	DCF416P
11510	DCF507P
11566	DCF002K
11566	DCF225K
11567	DCF446P
11568	DCF056K

FEBI BILSTEIN	DENSO
11741	DCF164K
11779	DCF142P
12263	DCF402P
12264	DCF015K
12618	DCF514P
12711	DCF016P
14770	DCF536P
14816	DCF474P
14817	DCF035K
15939	DCF502P
17151	DCF068K
17263	DCF223K
17264	DCF486P
17311	DCF018P
17474	DCF090K
17554	DCF094K
17796	DCF056K
18641	DCF062K
18915	DCF493P
19439	DCF480P
19440	DCF105K
19441	DCF270P
19538	DCF072K
19538	DCF343K
19588	DCF054K
19590	DCF462P
19592	DCF458K
19726	DCF463P
19967	DCF517P
19984	DCF492P
21125	DCF340K
21139	DCF071K
21308	DCF231K
21312	DCF449P
21314	DCF052K
21316	DCF477P
21318	DCF234K
21359	DCF480P
21361	DCF480P
21642	DCF152K
21643	DCF412P
21650	DCF065K
21651	DCF064P
21651	DCF475P
21930	DCF510P
21932	DCF227P
21932	DCF526P
21952	DCF262P
22069	DCF403P
22070	DCF419K
22165	DCF471P
22166	DCF106K
22282	DCF522P
22284	DCF122K
223092	DCF582P
22378	DCF475P
22440	DCF345K
22441	DCF181K
22442	DCF412P
23407	DCF063K
23409	DCF061P
23683	DCF450K
23684	DCF096P
23716	DCF144P
23717	DCF418P
23782	DCF252K
23788	DCF181K
23802	DCF413P
23921	DCF170K
24411	DCF469P
24415	DCF512P
24425	DCF466P
24433	DCF357P

FEBI BILSTEIN	DENSO
24434	DCF353P
24439	DCF366P
24440	DCF410P
24457	DCF109P
24526	DCF561P
24540	DCF211K
24542	DCF268P
24554	DCF306P
24567	DCF284P
24569	DCF283P
24590	DCF053K
24810	DCF457K
24827	DCF562P
26302	DCF516P
26417	DCF532P
26419	DCF513P
26441	DCF540P
27243	DCF563P
27423	DCF486P
27465	DCF382P
27829	DCF467P
27833	DCF309P
27838	DCF326P
27868	DCF488P
27870	DCF506P
27872	DCF504P
27873	DCF499P
27874	DCF497P
27875	DCF048K
27908	DCF295P
27923	DCF566P
27943	DCF266P
27944	DCF361P
27945	DCF285P
27948	DCF083P
27950	DCF560P
27951	DCF454P
27952	DCF332K
27953	DCF473P
27976	DCF479P
28191	DCF162K
28323	DCF374P
28380	DCF567P
28683	DCF448K
29212	DCF460P
29213	DCF371P
29220	DCF073K
29221	DCF485P
29308	DCF344K
29467	DCF465P
29468	DCF236K
29793	DCF452P
29794	DCF453K
30242	DCF382P
30434	DCF242P
30435	DCF300K
30640	DCF081K
30642	DCF168K
30743	DCF564P
30861	DCF286P
30862	DCF411P
31167	DCF521P
31168	DCF172K
32366	DCF564P
32367	DCF200K
32368	DCF199K
32369	DCF201K
32552	DCF480P
32589	DCF245P
32609	DCF573P
32756	DCF279P
32760	DCF263P
33924	DCF457K

Cabin Air Filter

Cross Reference Chart - OE

FEBI BILSTEIN	DENSO
34187	DCF376P
34199	DCF255P
34313	DCF570P
34478	DCF502P
34554	DCF569P
34555	DCF582P
34556	DCF509P
34558	DCF239K
34781	DCF420K
34824	DCF568P
34895	DCF365K
34998	DCF044K
36002	DCF450K
36026	DCF460K
36027	DCF073K
36028	DCF332K
36029	DCF346K
36030	DCF072K
36039	DCF562P
36040	DCF454P
36041	DCF536P
36063	DCF347K
36179	DCF163K
36181	DCF160K
36447	DCF125K
36493	DCF048K
37113	DCF581P
37313	DCF571P
37314	DCF576P
37316	DCF576P
37327	DCF413P
37416	DCF221K
37723	DCF583P
37785	DCF170K
37787	DCF144P
37787	DCF145P
38781	DCF587P
43457	DCF053K
44783	DCF580P
44784	DCF579P
45613	DCF351K
47806	DCF564P
47807	DCF585P
48465	DCF575P
48498	DCF471P
48500	DCF579P
48503	DCF564P
48533	DCF059K
49664	DCF127K

FILTRON	DENSO
K 1210A	DCF385K
K 1323	DCF383P
K1000	DCF541P
K1001A	DCF196K
K1002	DCF031P
K1004	DCF508P
K1004A	DCF050K
K1006	DCF461P
K1006A	DCF225K
K1007	DCF018P
K1014	DCF476P
K1014A	DCF200K
K1016	DCF009P
K1016A	DCF068K
K1017	DCF109P
K1020A	DCF351K
K1032A	DCF056K
K1035A	DCF044K
K1037	DCF446P
K1038	DCF086P
K1044-2X	DCF550P
K1047A	DCF002K

FILTRON	DENSO
K1051	DCF270P
K1052	DCF502P
K1053-2X	DCF514P
K1054	DCF474P
K1055	DCF482P
K1056	DCF536P
K1065	DCF495P
K1066	DCF493P
K1068	DCF287P
K1075A-2X	DCF015K
K1078	DCF463P
K1078A	DCF054K
K1079A	DCF458K
K1081	DCF481P
K1081A	DCF223K
K1083	DCF353P
K1083A	DCF384K
K1088	DCF537P
K1090	DCF227P
K1090	DCF526P
K1093	DCF470P
K1093A	DCF071K
K1096	DCF190P
K1101	DCF504P
K1102	DCF513P
K1103A	DCF039K
K1104A	DCF090K
K1105A-2X	DCF048K
K1106A	DCF152K
K1110	DCF478P
K1110A	DCF105K
K1111	DCF449P
K1111A	DCF052K
K1115	DCF302P
K1118A	DCF059K
K1119	DCF061P
K1119A	DCF063K
K1120A	DCF341K
K1123	DCF469P
K1125A	DCF346K
K1126	DCF494P
K1126A	DCF343K
K1127	DCF540P
K1128	DCF072K
K1128	DCF532P
K1136	DCF016P
K1136A	DCF062K
K1137A	DCF347K
K1138	DCF510P
K1138A	DCF199K
K1143-2X	DCF286P
K1146A	DCF144P
K1146A	DCF252K
K1147A	DCF211K
K1148	DCF517P
K1150	DCF465P
K1150	DCF471P
K1154A	DCF106K
K1155	DCF477P
K1155A	DCF234K
K1162-2X	DCF522P
K1162A-2X	DCF122K
K1165-2X	DCF064P
K1165-2X	DCF065K
K1166	DCF243P
K1168A	DCF067K
K1179-2x	DCF560P
K1180-2X	DCF303P
K1182-2X	DCF266P
K1187	DCF561P
K1188	DCF521P
K1198-2X	DCF512P
K1200A-2X	DCF163K

FILTRON	DENSO
K1201A-2X	DCF168K
K1202A	DCF453K
K1204A	DCF345K
K1205A	DCF170K
K1207	DCF562P
K1210	DCF382P
K1212-2x	DCF563P
K1221A-2X	DCF162K
K1223	DCF564P
K1230	DCF565P
K1237	DCF566P
K1239	DCF567P
K1248-2x	DCF568P
K1250	DCF569P
K1257-2x	DCF570P
K1278	DCF571P
K1292	DCF572P
K1298	DCF573P
K1308	DCF574P
K1310	DCF386P
K1310A	DCF387K
K1311	DCF575P
K1313	DCF576P
K1314	DCF577P
K1316	DCF578P
K1321	DCF579P
K1322	DCF580P
K1331	DCF581P
K1332	DCF582P
K1333	DCF583P
K1335	DCF584P
K1347	DCF585P
K1351	DCF586P
K1353	DCF587P
K1355	DCF588P
K1369	DCF590P
K1377	DCF589P
K1381	DCF388P

FRAM	DENSO
C9395	DCF075P
C9408	DCF090K
CF10062	DCF561P
CF10067	DCF414P
CF10080	DCF562P
CF10087	DCF411P
CF10204-2	DCF560P
CF10218-2	DCF563P
CF10284	DCF383P
CF10285	DCF382P
CF10285	DCF385K
CF10322	DCF382P
CF10442	DCF566P
CF10457	DCF571P
CF10534-2	DCF568P
CF10761	DCF586P
CF10774	DCF564P
CF10831	DCF567P
CF10889	DCF582P
CF10933-2	DCF570P
CF11119	DCF565P
CF11152	DCF572P
CF11182	DCF573P
CF11243	DCF574P
CF11434	DCF577P
CF11464	DCF583P
CF11470	DCF580P
CF11472	DCF581P
CF11484	DCF589P
CF11662	DCF584P
CF11706	DCF579P
CF11719	DCF587P
CF11811	DCF578P

FRAM	DENSO
CF11854	DCF588P
CF11862	DCF386P
CF11862	DCF387K
CF11862	DCF590P
CF11953	DCF585P
CF12058	DCF577P
CF12214	DCF388P
CF5475	DCF541P
CF5551	DCF018P
CF5662	DCF508P
CF5663	DCF461P
CF5665	DCF031P
CF5819	DCF507P
CF5842	DCF009P
CF5850	DCF500P
CF5865	DCF109P
CF5891	DCF042P
CF5972	DCF514P
CF8717	DCF412P
CF8719	DCF286P
CF8777	DCF495P
CF8799	DCF270P
CF8831	DCF474P
CF8838	DCF502P
CF8867	DCF482P
CF8868	DCF476P
CF8890	DCF536P
CF8913	DCF016P
CF8914	DCF550P
CF8989	DCF086P
CF9051	DCF537P
CF9071	DCF493P
CF9077	DCF083P
CF9294	DCF540P
CF9323	DCF576P
CF9335	DCF227P
CF9335	DCF526P
CF9364	DCF492P
CF9396	DCF494P
CF9398	DCF470P
CF9399	DCF255P
CF9408	DCF504P
CF9414	DCF268P
CF9442	DCF413P
CF9495	DCF481P
CF9562	DCF405P
CF9579	DCF446P
CF9586	DCF532P
CF9645	DCF463P
CF9686	DCF469P
CF9756	DCF410P
CF9846	DCF384K
CF9880	DCF302P
CF9881	DCF477P
CF9882	DCF389K
CF9882	DCF467P
CF9934	DCF418P
CFA10103-2	DCF419K
CFA10285	DCF385K
CFA10366	DCF332K
CFA11862	DCF386P
CFA11862	DCF387K
CFA8869	DCF002K
CFA8874	DCF196K
CFA8876	DCF056K
CFA8878	DCF094K
CFA8882	DCF050K
CFA8893	DCF225K
CFA8894	DCF044K
CFA8912-2	DCF015K
CFA9404	DCF458K
CFA9405	DCF048K
CFA9445	DCF345K

Cabin Air Filter

Cross Reference Chart - OE

FRAM	DENSO
CFA9495	DCF223K
CFA9533	DCF039K
CFA9533	DCF497P
CFA9548	DCF054K
CFA9562	DCF346K
CFA9587	DCF071K
CFA-9785	DCF252K
CFA9909	DCF352K

FRIGAIR	DENSO
1301.5289	DCF127K
1301.5289	DCF516P
1301.5324	DCF411P
1301.5383	DCF109P
1301.5392	DCF286P
1302.4109	DCF015K
1302.4109	DCF402P
1302.4222	DCF062K
1302.4226	DCF063K
1302.4229	DCF419K
1302.4252	DCF065K
1302.4277	DCF450K
1302.5322	DCF016P
1302.5324	DCF064P
1302.5324	DCF475P
1302.5326	DCF061P
1302.5329	DCF403P
1302.5331	DCF420K
1302.5332	DCF567P
1302.5359	DCF402P
1302.5377	DCF096P
1302.5396	DCF340K
1302.5396	DCF475P
1302.5397	DCF581P
1303.4240	DCF346K
1303.4319	DCF073K
1303.5290	DCF562P
1303.5300	DCF454P
1303.5306	DCF513P
1303.5319	DCF479P
1303.5340	DCF405P
1303.5341	DCF018P
1303.5393	DCF540P
1304.4145	DCF042P
1304.4145	DCF044K
1304.4145	DCF507P
1304.4151	DCF090K
1304.4199	DCF083P
1304.4199	DCF497P
1304.4204	DCF072K
1304.4279	DCF201K
1304.4280	DCF223K
1304.4318	DCF332K
1304.5126	DCF584P
1304.5294	DCF466P
1304.5304	DCF532P
1304.5308	DCF125K
1304.5323	DCF499P
1304.5334	DCF090K
1304.5334	DCF504P
1304.5335	DCF485P
1304.5350	DCF044K
1304.5350	DCF507P
1304.5351	DCF090K
1304.5371	DCF536P
1304.5379	DCF201K
1304.5379	DCF488P
1304.5387	DCF083P
1304.5388	DCF580P
1305.1189	DCF517P
1305.4206	DCF105K
1305.4243	DCF106K
1305.4273	DCF236K

FRIGAIR	DENSO
1305.4347	DCF365K
1305.5322	DCF589P
1305.5343	DCF471P
1305.5373	DCF465P
1305.5382	DCF471P
1305.5386	DCF474P
1306.4154	DCF035K
1306.4161	DCF152K
1306.4214	DCF144P
1306.4214	DCF252K
1306.4254	DCF068K
1306.5215	DCF168K
1306.5314	DCF144P
1306.5315	DCF009P
1306.5316	DCF452P
1306.5316	DCF453K
1306.5317	DCF521P
1306.5318	DCF170K
1306.5319	DCF181K
1306.5326	DCF341K
1306.5326	DCF412P
1306.5355	DCF514P
1306.5378	DCF163K
1307.5325	DCF227P
1307.5325	DCF526P
1307.5355	DCF564P
1308.4105	DCF351K
1308.4158	DCF460K
1308.4184	DCF071K
1308.4187	DCF347K
1308.4255	DCF211K
1308.5312	DCF560P
1308.5358	DCF493P
1308.5387	DCF347K
1309.5128	DCF579P
1309.5330	DCF492P
1309.5351	DCF568P
1309.5367	DCF586P
1309.5368	DCF416P
1309.5380	DCF270P
1309.5381	DCF502P
1310.4137	DCF050K
1310.4168	DCF458K
1310.4191	DCF054K
1310.4225	DCF052K
1310.5311	DCF462P
1310.5320	DCF094K
1310.5320	DCF500P
1310.5325	DCF449P
1310.5327	DCF234K
1310.5327	DCF477P
1310.5328	DCF446P
1310.5329	DCF002K
1310.5329	DCF225K
1310.5329	DCF461P
1310.5334	DCF571P
1310.5346	DCF400P
1310.5348	DCF508P
1310.5373	DCF268P
1310.5381	DCF576P
1310.5383	DCF575P
1310.5384	DCF583P
1310.5390	DCF002K
1310.5391	DCF463P
1310.5392	DCF122K
1310.5392	DCF522P
1311.5310	DCF072K
1311.5310	DCF343K
1311.5321	DCF566P
1311.5365	DCF072K
1311.5365	DCF343K
1313.4181	DCF048K
1313.4292	DCF448K

FRIGAIR	DENSO
1313.5292	DCF506P
1313.5331	DCF048K
1313.5366	DCF572P
1314.5302	DCF377P
1314.5335	DCF230P
1314.5335	DCF375P
1314.5397	DCF374P
1315.5285	DCF361P
1315.5304	DCF353P
1315.5304	DCF357P
1315.5306	DCF382P
1315.5311	DCF353P
1315.5311	DCF354P
1315.5318	DCF469P
1315.5394	DCF239K
1315.5394	DCF353P
1315.5394	DCF384K
1315.5394	DCF303P
1315.5326	DCF300K
1316.5341	DCF053K
1318.5210	DCF120K
1318.5314	DCF080K
1318.5388	DCF067K
1319.5229	DCF561P
1319.5313	DCF473P
1319.5316	DCF255P
1319.5357	DCF573P
1319.5398	DCF512P
1321.4258	DCF509P
1321.5258	DCF509P
1321.5269	DCF565P
1321.5307	DCF190P
1321.5317	DCF467P
1321.5372	DCF574P
1321.5391	DCF376P
1325.5234	DCF480P
1325.5286	DCF563P
1328.5153	DCF263P
1328.5153	DCF577P
1328.5205	DCF582P
1328.5213	DCF408P
1328.5315	DCF366P
1328.5337	DCF268P
1328.5338	DCF486P
1328.5350	DCF570P
1328.5374	DCF266P
1329.5336	DCF118K
1330.5293	DCF243P
1330.5307	DCF245P
1330.5317	DCF242P
1330.5388	DCF075P
1330.5389	DCF076P
1333.5236	DCF279P
1333.5270	DCF284P
1333.5312	DCF410P
1404.2040	DCF044K
1404.2040	DCF507P
1406.2030	DCF537P
1407.2042	DCF418P

HELLA	DENSO
8FL352159-061	DCF018P
8FL352159-081	DCF190P
8FL352159-131	DCF056K
8FL352159-151	DCF500P
8FL352159-201	DCF200K
8FL352159-211	DCF476P
8FL352159-221	DCF482P
8FL352159-261	DCF446P
8FL352159-291	DCF474P
8FL352159-311	DCF502P
8FL352159-341	DCF514P
8FL352159-391	DCF541P

HELLA	DENSO
8FL352159-421	DCF461P
8FL352159-431	DCF009P
8FL352159-441	DCF507P
8FL352159-471	DCF031P
8FL352159-541	DCF160K
8FL352215-081	DCF002K
8FL352215-091	DCF508P
8FL352215-261	DCF162K
8FL352215-281	DCF072K
FL352159-191	DCF537P

HENGST FILTER	DENSO
E1903LC	DCF105K
E1903LI	DCF478P
E1906LI	DCF512P
E1907LC	DCF106K
E1907LI	DCF471P
E1909LC	DCF419K
E1909LI	DCF403P
E1910LC	DCF234K
E1910LI	DCF477P
E1911LC	DCF071K
E1911LI	DCF470P
E1912LC	DCF341K
E1912LI	DCF412P
E1913LI	DCF159P
E1914LC	DCF199K
E1914LI	DCF510P
E1915LI	DCF540P
E1916LC01	DCF072K
E1916LI	DCF494P
E1918LC	DCF453K
E1918LI	DCF452P
E1919LC	DCF160K
E1920LC	DCF065K
E1920LI	DCF064P
E1925LC	DCF221K
E1926LI	DCF480P
E1927LI	DCF469P
E1928LC	DCF181K
E1929LI	DCF499P
E1930LC	DCF048K
E1934LC	DCF044K
E1935LC	DCF231K
E1937LI	DCF563P
E1938LC	DCF457K
E1939LI	DCF413P
E1940LI	DCF295P
E1943LC	DCF340K
E1943LI	DCF475P
E1944LC	DCF122K
E1944LI	DCF522P
E1947LI	DCF507P
E1948LI	DCF083P
E1951LI	DCF255P
E1953LI	DCF227P
E1953LI	DCF526P
E1959LC	DCF450K
E1959LI	DCF096P
E1962LC	DCF090K
E1962LI	DCF504P
E1963LC	DCF072K
E1963LI	DCF532P
E1965LC	DCF053K
E1965LC01	DCF053K
E1966LI	DCF423P
E1967LI	DCF309P
E1975LI	DCF190P
E1976LI	DCF284P
E1978LC	DCF059K
E1981LI	DCF303P
E1984LI	DCF418P
E1987LI	DCF190P

Cabin Air Filter

Cross Reference Chart - OE

HENGST FILTER	DENSO
E1990LC	DCF236K
E1997LI	DCF283P
E1998LC	DCF300K
E1999LI	DCF280P
E2902LI	DCF193P
E2904LC	DCF170K
E2906LI	DCF562P
E2907LI	DCF410P
E2910LI	DCF375P
E2913LC	DCF172K
E2913LI	DCF521P
E2914LI	DCF243P
E2915LC	DCF239K
E2915LC	DCF384K
E2915LI	DCF353P
E2916LC	DCF081K
E2916LI	DCF511P
E2918LI	DCF473P
E2919LC	DCF166K
E2925LI	DCF486P
E2930LI	DCF357P
E2933LC	DCF420K
E2934LI	DCF361P
E2936LI	DCF414P
E2937LC	DCF347K
E2939LC	DCF201K
E2940LI	DCF454P
E2943LI	DCF560P
E2945LC	DCF385K
E2945LI	DCF382P
E2947LI	DCF567P
E2948LI	DCF571P
E2949LI	DCF566P
E2951LC	DCF332K
E2955LI	DCF371P
E2957LI	DCF466P
E2959LI	DCF466P
E2962LI	DCF564P
E2963LC	DCF419K
E2963LI	DCF403P
E2964LC	DCF365K
E2964LI	DCF489P
E2967LI-2	DCF560P
E2970LI-2	DCF563P
E2975LI	DCF586P
E2976LI	DCF509P
E2977LI-2	DCF479P
E2979LC	DCF071K
E2979LI	DCF470P
E2981LI	DCF242P
E2982LI-2	DCF568P
E2983LI	DCF569P
E2984LI	DCF483P
E2985LI	DCF565P
E2987LI	DCF485P
E2988LI	DCF583P
E2989LI	DCF483P
E2990LI	DCF561P
E2991LI	DCF581P
E2994LI	DCF589P
E2995LI	DCF582P
E2997LI	DCF574P
E2998LI	DCF575P
E3900LI	DCF587P
E3902LI	DCF263P
E3902LI	DCF577P
E3903LI	DCF578P
E3905LI	DCF471P
E3908LI	DCF460P
E3910LI	DCF580P
E3914LI	DCF579P
E3915LI-2	DCF570P
E3917LC	DCF344K

HENGST FILTER	DENSO
E3918LI	DCF579P
E3919LI	DCF576P
E3928LI-2	DCF563P
E3929LI	DCF573P
E3933LI	DCF376P
E3952LI	DCF588P
E3953LI	DCF584P
E3957LI	DCF377P
E3960LI	DCF245P
E3973LI	DCF590P
E3974LC	DCF120K
E3975LC	DCF080K
E3976LI	DCF506P
E3977LI	DCF467P
E3979LI	DCF502P
E3982LC	DCF127K
E3982LI	DCF516P
E3986LC	DCF067K
E3987LI	DCF572P
E3996LI	DCF585P
E3998LI	DCF380P
E4921LI	DCF411P
E4937LI	DCF381P
E4955LI	DCF388P
E4959LI	DCF386P
E900LC	DCF002K
E900LI	DCF461P
E901LI	DCF541P
E902LI	DCF031P
E903LC	DCF196K
E905LC	DCF050K
E905LI	DCF508P
E907LI	DCF517P
E909LI	DCF550P
E910LC	DCF200K
E910LI	DCF476P
E911LC	DCF198K
E911LI	DCF482P
E912LI	DCF537P
E913LC	DCF035K
E913LI	DCF495P
E914LC	DCF068K
E914LC01	DCF068K
E914LC-R	DCF068K
E914LI	DCF009P
E919LC	DCF094K
E919LI	DCF500P
E922LI	DCF446P
E934LI	DCF042P
E934LI	DCF507P
E935LI	DCF109P
E936LC	DCF056K
E941LI	DCF474P
E942LI	DCF514P
E950LI	DCF086P
E951LC	DCF351K
E953LI	DCF536P
E955LC	DCF054K
E957LC	DCF164K
E957LI	DCF141P
E960LC	DCF015K
E960LI	DCF402P
E961LC	DCF458K
E961LI	DCF462P
E962LI	DCF502P
E964LC	DCF345K
E967LI	DCF270P
E968LI	DCF517P
E970LC	DCF152K
E970LC01	DCF161K
E970LC02	DCF153K
E970LC-R	DCF153K
E971LC01	DCF460K

HENGST FILTER	DENSO
E971LI	DCF493P
E971L01	DCF493P
E972LC	DCF223K
E972LI	DCF481P
E975LC	DCF389K
E977LC	DCF062K
E977LI	DCF016P
E978LI	DCF513P
E981LI	DCF416P
E983LI	DCF262P
E989LC01	DCF162K
E989LI	DCF144P
E989L01	DCF145P
E989LI-R	DCF145P
E990LC	DCF346K
E990LC02	DCF211K
E990LI	DCF405P
E991LI	DCF302P
E994LC01	DCF063K
E994L01	DCF061P
E997LI	DCF492P
E998LC	DCF052K
E998LC01	DCF053K
E998LC-R	DCF053K
E998LI	DCF449P

HERTH+BUSS	DENSO
G1343000	DCF120K
J1321036	DCF568P
J1340301	DCF283P
J1340301	DCF285P
J1340302	DCF280P
J1340304	DCF279P
J1340305	DCF284P
J1340308	DCF285P
J1340310	DCF483P
J1340311	DCF283P
J1340314	DCF569P
J1340316	DCF582P
J1340320	DCF388P
J1340500	DCF410P
J1340501	DCF210P
J1340501	DCF408P
J1340503	DCF366P
J1340504	DCF266P
J1340507	DCF486P
J1340508	DCF268P
J1340511	DCF263P
J1340511	DCF577P
J1340512	DCF577P
J1340521	DCF582P
J1340522	DCF570P
J1340530	DCF582P
J1340532	DCF582P
J1340902	DCF076P
J1340902	DCF078P
J1340903	DCF075P
J1340906	DCF242P
J1340907	DCF243P
J1340908	DCF245P
J1340909	DCF371P
J1340910	DCF564P
J1340912	DCF564P
J1341002	DCF467P
J1341002	DCF589P
J1341003	DCF190P
J1341013	DCF187P
J1341014	DCF467P
J1341016	DCF502P
J1341020	DCF509P
J1341023	DCF502P
J1341028	DCF565P
J1341032	DCF574P

HERTH+BUSS	DENSO
J1341036	DCF568P
J1341037	DCF418P
J1341039	DCF588P
J1342000	DCF361P
J1342001	DCF357P
J1342004	DCF354P
J1342005	DCF354P
J1342010	DCF353P
J1342010	DCF354P
J1342011	DCF239K
J1342016	DCF239K
J1342016	DCF384K
J1342018	DCF239K
J1342018	DCF353P
J1342020	DCF383P
J1342020	DCF469P
J1342024	DCF382P
J1342024	DCF385K
J1342025	DCF562P
J1342027	DCF382P
J1342027	DCF385K
J1342028	DCF382P
J1342035	DCF382P
J1342038	DCF389K
J1342039	DCF585P
J1342041	DCF332K
J1342042	DCF479P
J1342044	DCF073K
J1342047	DCF387K
J1342048	DCF386P
J1343001	DCF295P
J1343005	DCF457K
J1343015	DCF563P
J1343021	DCF563P
J1343024	DCF578P
J1344001	DCF255P
J1344004	DCF109P
J1344006	DCF512P
J1344007	DCF466P
J1344010	DCF255P
J1344010	DCF561P
J1344012	DCF473P
J1344015	DCF573P
J1345001	DCF302P
J1345001	DCF303P
J1345002	DCF309P
J1345003	DCF306P
J1345006	DCF053K
J1345007	DCF423P
J1345008	DCF300K
J1345009	DCF181K
J1345010	DCF053K
J1345011	DCF344K
J1345013	DCF336K
J1345014	DCF336K
J1347001	DCF326P
J1348000	DCF374P
J1348001	DCF526P
J1348002	DCF330P
J1348003	DCF230P
J1348003	DCF375P
J1348004	DCF374P
J1348005	DCF466P
J1348006	DCF377P
J1348008	DCF460P
J1348010	DCF376P
J1348013	DCF380P
J1348016	DCF590P

HOFFER	DENSO
17532	DCF590P

JAPANPARTS	DENSO
FAA-BY00	DCF096P

JAPANPARTS	DENSO
FAA-BY00	DCF450K
FAA-CD0	DCF486P
FAA-CH0	DCF067K
FAA-CH2	DCF009P
FAA-CH2	DCF068K
FAA-CH3	DCF120K
FAA-CH4	DCF080K
FAA-CH5	DCF069K
FAA-DC02	DCF579P
FAA-DDW0	DCF076P
FAA-DDW0	DCF078P
FAA-DDW1	DCF075P
FAA-DDW10	DCF243P
FAA-DDW11	DCF242P
FAA-DDW12	DCF371P
FAA-DDW13	DCF243P
FAA-DDW14	DCF245P
FAA-DDW15	DCF564P
FAA-H011	DCF561P
FAA-H012	DCF573P
FAA-H013	DCF570P
FAA-H03	DCF255P
FAA-H04	DCF512P
FAA-H09	DCF473P
FAA-HY03	DCF366P
FAA-HY05	DCF266P
FAA-HY08	DCF408P
FAA-HY11	DCF486P
FAA-HY28	DCF263P
FAA-HY28	DCF577P
FAA-HY29	DCF582P
FAA-JE3	DCF584P
FAA-KI00	DCF280P
FAA-KI05	DCF279P
FAA-KI06	DCF410P
FAA-KI07	DCF283P
FAA-KI09	DCF284P
FAA-KI11	DCF268P
FAA-KI15	DCF285P
FAA-KI18	DCF483P
FAA-KI20	DCF569P
FAA-KI23	DCF582P
FAA-LR2	DCF411P
FAA-LR3	DCF286P
FAA-LR4	DCF127K
FAA-LR4	DCF516P
FAA-MA0	DCF457K
FAA-MA10	DCF480P
FAA-MA15	DCF578P
FAA-MA5	DCF480P
FAA-MA8	DCF563P
FAA-MI1	DCF306P
FAA-MI2	DCF303P
FAA-MI3	DCF309P
FAA-MI4	DCF053K
FAA-MI5	DCF300K
FAA-MI7	DCF273K
FAA-MI7	DCF344K
FAA-MI7	DCF467P
FAA-MI8	DCF423P
FAA-NS0	DCF190P
FAA-NS10	DCF509P
FAA-NS11	DCF418P
FAA-NS12	DCF502P
FAA-NS13	DCF565P
FAA-NS15	DCF574P
FAA-NS21	DCF568P
FAA-NS22	DCF588P
FAA-NS22	DCF588P
FAA-NS4	DCF467P
FAA-NS7	DCF187P
FAA-SB0	DCF590P
FAA-SB2	DCF239K
FAA-SB2	DCF353P

JAPANPARTS	DENSO
FAA-SB5	DCF326P
FAA-SM0	DCF345K
FAA-SM1	DCF181K
FAA-SM1	DCF305P
FAA-SZ01	DCF374P
FAA-SZ02	DCF230P
FAA-SZ02	DCF375P
FAA-SZ03	DCF526P
FAA-SZ04	DCF330P
FAA-SZ05	DCF227P
FAA-SZ05	DCF526P
FAA-SZ07	DCF377P
FAA-SZ08	DCF466P
FAA-SZ09	DCF460P
FAA-SZ10	DCF376P
FAA-SZ13	DCF380P
FAA-TY1	DCF361P
FAA-TY10	DCF562P
FAA-TY12	DCF239K
FAA-TY13	DCF382P
FAA-TY15	DCF585P
FAA-TY1DX	DCF361P
FAA-TY2	DCF357P
FAA-TY20	DCF386P
FAA-TY20	DCF387K
FAA-TY3	DCF354P
FAA-TY5	DCF353P
FAA-TY5	DCF354P
FAA-TY7	DCF383P
FAA-TY7	DCF469P
FAA-TY8	DCF239K
FAA-TY8	DCF353P
FAA-TY8	DCF384K
FAA-TY9	DCF382P
FAA-TY9	DCF385K

JAPKO	DENSO
21DC02	DCF579P
21H011	DCF561P
21H012	DCF573P
21H013	DCF570P
21H28	DCF577P
21H29	DCF582P
21JE3	DCF584P
21K20	DCF569P
21K23	DCF582P
21MA15	DCF578P
21MA8	DCF563P
21NS13	DCF565P
21NS15	DCF574P
21NS21	DCF568P
21NS22	DCF588P
21SB0	DCF590P
21TY10	DCF562P
21TY13	DCF382P
21TY15	DCF585P
21TY20	DCF386P
21TY20	DCF387K
21TY7	DCF383P
21TY8	DCF384K
21TY9	DCF382P
21TY9	DCF385K
21W15	DCF564P

KAVO	DENSO
SC-9516	DCF590P
TC1003C	DCF384K
TC1010	DCF383P
TC1018	DCF382P

KNECHT	DENSO
6418503.76418503	DCF571P
6889331.76889331	DCF567P

KNECHT	DENSO
70329438	DCF560P
70346564	DCF563P
70347264	DCF562P
70371991	DCF577P
70384252	DCF561P
70511166	DCF573P
70518021	DCF564P
70519372	DCF566P
70521862	DCF568P
70562254	DCF581P
70569576	DCF572P
70570876	DCF583P
70572795	DCF576P
70585208	DCF582P
70591266	DCF574P
70591295	DCF571P
70591308	DCF569P
70591367	DCF587P
70602113	DCF589P
72347207	DCF584P
72347757	DCF586P
72347796	DCF580P
72347808	DCF579P
72351819	DCF575P
72389288	DCF570P
72416197	DCF588P
72435408	DCF578P
76419071	DCF561P
LA 348	DCF383P
LA 395	DCF382P
LA1139	DCF578P
LA1176	DCF588P
LA171	DCF567P
LA191/S	DCF560P
LA216	DCF561P
LA304	DCF562P
LA345	DCF590P
LA346/S	DCF563P
LA386	DCF571P
LA387	DCF566P
LA435	DCF561P
LA447	DCF577P
LA462	DCF573P
LA464	DCF582P
LA468/S	DCF568P
LA472	DCF564P
LA495/S	DCF570P
LA587	DCF569P
LA635	DCF574P
LA686	DCF586P
LA742	DCF581P
LA809	DCF576P
LA811	DCF583P
LA813	DCF572P
LA859	DCF589P
LA877	DCF587P
LA888	DCF575P
LA889	DCF584P
LA922	DCF580P
LA923	DCF579P
LA93	DCF571P
LAK 119	DCF389K
LAK 131	DCF384K
LAK 490	DCF385K

LUCAS FILTERS	DENSO
LFCP152	DCF384K
LFCP159S	DCF560P
LFCP177	DCF571P
LFCP180	DCF566P
LFCP182	DCF567P
LFCP183	DCF562P
LFCP187S	DCF568P

LUCAS FILTERS	DENSO
LFCP191	DCF382P
LFCP191	DCF385K
LFCP192	DCF564P
LFCP194	DCF582P
LFCP195S	DCF563P
LFCP196	DCF561P
LFCP202	DCF565P
LFCP208	DCF573P
LFCP213	DCF569P
LFCP217S	DCF570P
LFCP219	DCF577P
LFCP224	DCF576P
LFCP225	DCF575P
LFCP243	DCF383P
LFCP255	DCF578P
LFCP256	DCF574P
LFCP258	DCF588P
LFCP269	DCF589P
LFCP271	DCF581P
LFCP273	DCF580P
LFCP274	DCF583P
LFCP276	DCF584P
LFCP280	DCF585P

MAGNETI MARELLI	DENSO
154068874590	DCF384K
154072415030	DCF389K
154703512360	DCF383P
154703565170	DCF382P
154703866270	DCF385K
161013420160	DCF384K
350203061070	DCF096P
350203061160	DCF109P
350203061170	DCF287P
350203061220	DCF461P
350203061310	DCF536P
350203061450	DCF462P
350203061470	DCF402P
350203061510	DCF083P
350203061530	DCF474P
350203061600	DCF190P
350203061620	DCF482P
350203061660	DCF270P
350203061700	DCF540P
350203061710	DCF492P
350203061730	DCF512P
350203061740	DCF227P
350203061740	DCF526P
350203061790	DCF497P
350203061820	DCF061P
350203061830	DCF463P
350203061850	DCF532P
350203061870	DCF517P
350203061880	DCF469P
350203061890	DCF357P
350203061890	DCF383P
350203061900	DCF353P
350203061910	DCF499P
350203061920	DCF471P
350203061930	DCF510P
350203061940	DCF466P
350203061960	DCF540P
350203061980	DCF452P
350203061990	DCF465P
350203062010	DCF488P
350203062020	DCF242P
350203062030	DCF516P
350203062040	DCF562P
350203062050	DCF473P
350203062070	DCF449P
350203062080	DCF096P
350203062100	DCF144P
350203062110	DCF561P

Cabin Air Filter

Cross Reference Chart - OE

MAGNETI MARELLI	DENSO
350203062120	DCF486P
350203062130	DCF413P
350203062140	DCF230P
350203062140	DCF375P
350203062160	DCF466P
350203062170	DCF368P
350203062180	DCF454P
350203062190	DCF568P
350203062200	DCF571P
350203062240	DCF477P
350203062250	DCF480P
350203062260	DCF521P
350203062270	DCF475P
350203062290	DCF465P
350203062300	DCF486P
350203062320	DCF410P
350203062340	DCF366P
350203062350	DCF280P
350203062360	DCF284P
350203062370	DCF418P
350203062380	DCF411P
350203062400	DCF467P
350203062420	DCF483P
350203062430	DCF509P
350203062440	DCF382P
350203062450	DCF485P
350203062460	DCF371P
350203062470	DCF567P
350203062510	DCF460P
350203062520	DCF245P
350203062530	DCF263P
350203062530	DCF577P
350203062560	DCF564P
350203062590	DCF303P
350203062600	DCF403P
350203062610	DCF522P
350203062620	DCF479P
350203062630	DCF266P
350203062640	DCF560P
350203062700	DCF563P
350203062730	DCF243P
350203062750	DCF405P
350203062760	DCF582P
350203062800	DCF566P
350203063080	DCF196K
350203063130	DCF094K
350203063220	DCF225K
350203063230	DCF056K
350203063430	DCF125K
350203063450	DCF458K
350203063490	DCF345K
350203063520	DCF090K
350203063540	DCF052K
350203063700	DCF071K
350203063800	DCF223K
350203063820	DCF063K
350203063830	DCF054K
350203063840	DCF105K
350203063860	DCF221K
350203063870	DCF181K
350203063880	DCF453K
350203063890	DCF448K
350203063920	DCF106K
350203063930	DCF252K
350203063970	DCF569P
350203064000	DCF582P
350203064010	DCF573P
350203064020	DCF572P
350203064050	DCF376P
350203064060	DCF576P
350203064090	DCF580P
350203064100	DCF565P
350203064130	DCF574P

MAGNETI MARELLI	DENSO
350203064140	DCF583P
350203064180	DCF377P
350203064240	DCF268P
350203065010	DCF201K
350203065080	DCF450K
350203065100	DCF589P
350203065980	DCF120K
350203066300	DCF579P
350203066310	DCF575P
350203066330	DCF584P
350203066340	DCF570P
350203066360	DCF581P
350203066400	DCF574P
350203066460	DCF588P
350203066470	DCF585P
350203066490	DCF578P
350203066530	DCF590P
359002320180	DCF382P
600000038490	DCF384K
600000038520	DCF383P
600000038540	DCF382P
600000038540	DCF385K
600000038570	DCF385K
600000038580	DCF382P
600000038640	DCF382P
BCF101	DCF009P
BCF104	DCF541P
BCF105	DCF508P
BCF107	DCF096P
BCF111	DCF031P
BCF113	DCF500P
BCF116	DCF109P
BCF117	DCF287P
BCF119	DCF018P
BCF122	DCF461P
BCF131	DCF536P
BCF133	DCF514P
BCF139	DCF042P
BCF141	DCF537P
BCF142	DCF502P
BCF145	DCF462P
BCF146	DCF016P
BCF147	DCF402P
BCF150	DCF513P
BCF151	DCF083P
BCF152	DCF504P
BCF153	DCF474P
BCF160	DCF190P
BCF161	DCF476P
BCF162	DCF482P
BCF163	DCF493P
BCF166	DCF270P
BCF170	DCF540P
BCF171	DCF492P
BCF173	DCF512P
BCF174	DCF227P
BCF174	DCF526P
BCF179	DCF497P
BCF182	DCF061P
BCF183	DCF463P
BCF185	DCF532P
BCF187	DCF517P
BCF188	DCF469P
BCF189	DCF357P
BCF189	DCF383P
BCF190	DCF353P
BCF191	DCF499P
BCF192	DCF471P
BCF193	DCF510P
BCF194	DCF466P
BCF196	DCF540P
BCF198	DCF452P
BCF199	DCF465P

MAGNETI MARELLI	DENSO
BCF201	DCF488P
BCF202	DCF242P
BCF203	DCF516P
BCF204	DCF562P
BCF205	DCF473P
BCF207	DCF449P
BCF208	DCF096P
BCF210	DCF144P
BCF211	DCF561P
BCF212	DCF486P
BCF213	DCF413P
BCF214	DCF230P
BCF214	DCF375P
BCF216	DCF466P
BCF217	DCF368P
BCF218	DCF454P
BCF219	DCF568P
BCF220	DCF571P
BCF224	DCF477P
BCF225	DCF480P
BCF226	DCF521P
BCF227	DCF475P
BCF229	DCF465P
BCF230	DCF486P
BCF232	DCF410P
BCF234	DCF366P
BCF235	DCF280P
BCF236	DCF284P
BCF237	DCF418P
BCF238	DCF411P
BCF240	DCF467P
BCF242	DCF483P
BCF243	DCF509P
BCF244	DCF382P
BCF245	DCF485P
BCF246	DCF371P
BCF247	DCF567P
BCF251	DCF460P
BCF252	DCF245P
BCF253	DCF263P
BCF253	DCF577P
BCF256	DCF564P
BCF259	DCF303P
BCF260	DCF403P
BCF261	DCF522P
BCF262	DCF479P
BCF263	DCF266P
BCF264	DCF560P
BCF270	DCF563P
BCF273	DCF243P
BCF275	DCF405P
BCF276	DCF582P
BCF280	DCF566P
BCF289	DCF506P
BCF305	DCF050K
BCF308	DCF196K
BCF313	DCF094K
BCF321	DCF044K
BCF322	DCF225K
BCF323	DCF056K
BCF340	DCF002K
BCF343	DCF125K
BCF345	DCF458K
BCF347	DCF015K
BCF348	DCF048K
BCF349	DCF345K
BCF352	DCF090K
BCF354	DCF052K
BCF356	DCF035K
BCF370	DCF071K
BCF380	DCF223K
BCF382	DCF063K
BCF383	DCF054K

MAGNETI MARELLI	DENSO
BCF384	DCF105K
BCF386	DCF221K
BCF387	DCF181K
BCF388	DCF453K
BCF389	DCF448K
BCF392	DCF106K
BCF393	DCF252K
BCF397	DCF569P
BCF400	DCF582P
BCF401	DCF573P
BCF402	DCF572P
BCF405	DCF376P
BCF406	DCF576P
BCF409	DCF580P
BCF410	DCF565P
BCF413	DCF574P
BCF414	DCF583P
BCF418	DCF377P
BCF424	DCF268P
BCF501	DCF201K
BCF508	DCF450K
BCF510	DCF589P
BCF598	DCF120K
BCF630	DCF579P
BCF631	DCF575P
BCF633	DCF584P
BCF634	DCF570P
BCF636	DCF581P
BCF640	DCF574P
BCF646	DCF588P
BCF647	DCF585P
BCF649	DCF578P
BCF653	DCF590P

MAHLE	DENSO
70329440	DCF560P
70346566	DCF563P
70347265	DCF562P
70371992	DCF577P
70384261	DCF561P
70511167	DCF573P
70518022	DCF564P
70519373	DCF566P
70521863	DCF568P
70562253	DCF581P
70569573	DCF572P
70570877	DCF583P
70572794	DCF576P
70585210	DCF582P
70591267	DCF574P
70591297	DCF571P
70591309	DCF569P
70591368	DCF587P
70602115	DCF589P
72347221	DCF584P
72347758	DCF586P
72347797	DCF580P
72347810	DCF579P
72351820	DCF575P
72389289	DCF570P
72416198	DCF588P
72435409	DCF578P
76418511	DCF571P
76419089	DCF561P
76889349	DCF567P
LA 109	DCF382P
LA 395	DCF383P
LA 516	DCF382P
LA 655	DCF382P
LA102	DCF016P
LA1043	DCF377P
LA1049	DCF465P
LA1065	DCF096P

MAHLE	DENSO
LA1089	DCF402P
LA109	DCF330P
LA109	DCF357P
LA11	DCF541P
LA1139	DCF578P
LA117	DCF481P
LA1176	DCF588P
LA120	DCF462P
LA122	DCF512P
LA123	DCF536P
LA125	DCF295P
LA126	DCF042P
LA127	DCF405P
LA130	DCF190P
LA131	DCF353P
LA136	DCF492P
LA137	DCF193P
LA138	DCF470P
LA143	DCF526P
LA144	DCF504P
LA152	DCF507P
LA153	DCF513P
LA155	DCF466P
LA156/1	DCF144P
LA156/1	DCF145P
LA157	DCF469P
LA158	DCF480P
LA167	DCF532P
LA168/S	DCF361P
LA169	DCF478P
LA171	DCF061P
LA171	DCF567P
LA172	DCF255P
LA173/S	DCF064P
LA173/S	DCF475P
LA175	DCF413P
LA18	DCF287P
LA181	DCF449P
LA182	DCF477P
LA184	DCF540P
LA186/S	DCF361P
LA189	DCF510P
LA191/S	DCF560P
LA195/S	DCF266P
LA197	DCF403P
LA199	DCF354P
LA21	DCF031P
LA216	DCF561P
LA220	DCF465P
LA220	DCF471P
LA227	DCF414P
LA229	DCF521P
LA239	DCF522P
LA24	DCF508P
LA241	DCF499P
LA242	DCF517P
LA248	DCF096P
LA25	DCF096P
LA251	DCF305P
LA252	DCF452P
LA265	DCF255P
LA280	DCF516P
LA287	DCF141P
LA288	DCF286P
LA291	DCF076P
LA293	DCF465P
LA296/S	DCF303P
LA301	DCF486P
LA304	DCF562P
LA306	DCF488P
LA307	DCF511P
LA31	DCF461P
LA344	DCF473P

MAHLE	DENSO
LA345	DCF590P
LA346/S	DCF563P
LA347	DCF410P
LA348	DCF383P
LA356	DCF283P
LA356/S	DCF283P
LA360	DCF411P
LA361	DCF242P
LA362	DCF243P
LA365/S	DCF279P
LA366/S	DCF423P
LA37	DCF009P
LA37/1	DCF009P
LA371	DCF467P
LA376	DCF302P
LA379	DCF118K
LA382	DCF418P
LA384	DCF306P
LA386	DCF571P
LA387	DCF566P
LA395	DCF382P
LA396	DCF509P
LA40	DCF416P
LA408	DCF377P
LA411	DCF454P
LA421	DCF371P
LA422	DCF497P
LA424	DCF467P
LA428/S	DCF479P
LA435	DCF561P
LA438	DCF219P
LA439	DCF368P
LA44	DCF268P
LA440	DCF366P
LA441	DCF483P
LA443	DCF480P
LA447	DCF262P
LA447	DCF263P
LA447	DCF577P
LA449	DCF460P
LA45	DCF508P
LA451	DCF309P
LA457	DCF485P
LA462	DCF573P
LA464	DCF582P
LA468/S	DCF568P
LA47/S	DCF514P
LA471	DCF284P
LA472	DCF564P
LA476	DCF075P
LA484	DCF210P
LA484	DCF408P
LA495/S	DCF570P
LA51/S	DCF400P
LA52	DCF500P
LA522	DCF462P
LA54	DCF494P
LA54/1	DCF494P
LA56	DCF507P
LA57	DCF493P
LA586	DCF376P
LA587	DCF569P
LA60	DCF270P
LA62	DCF475P
LA624	DCF245P
LA63	DCF002K
LA635	DCF574P
LA649	DCF284P
LA65	DCF446P
LA657	DCF375P
LA686	DCF586P
LA74	DCF482P
LA742	DCF581P

MAHLE	DENSO
LA75	DCF476P
LA78	DCF474P
LA8	DCF018P
LA809	DCF576P
LA81	DCF035K
LA811	DCF583P
LA813	DCF572P
LA82	DCF109P
LA83	DCF537P
LA84	DCF109P
LA851	DCF280P
LA859	DCF589P
LA862/S	DCF159P
LA87	DCF502P
LA877	DCF587P
LA888	DCF575P
LA889	DCF584P
LA896/S	DCF268P
LA907	DCF268P
LA922	DCF580P
LA923	DCF579P
LA93	DCF463P
LA93	DCF571P
LA932/S	DCF187P
LA935/S	DCF285P
LA941/S	DCF268P
LA942	DCF410P
LA97	DCF083P
LA98	DCF412P
LAK1003	DCF300K
LAK102	DCF062K
LAK117	DCF223K
LAK120	DCF458K
LAK122	DCF512P
LAK1231	DCF365K
LAK124	DCF090K
LAK1241/S	DCF073K
LAK127	DCF346K
LAK129/1	DCF152K
LAK129/1	DCF153K
LAK131	DCF239K
LAK131	DCF384K
LAK135	DCF513P
LAK138	DCF071K
LAK141	DCF048K
LAK142	DCF039K
LAK143	DCF227P
LAK143	DCF526P
LAK152	DCF044K
LAK156	DCF252K
LAK158	DCF480P
LAK159	DCF067K
LAK169	DCF105K
LAK171	DCF063K
LAK173	DCF065K
LAK176	DCF059K
LAK181	DCF052K
LAK181/1	DCF053K
LAK182	DCF234K
LAK189	DCF199K
LAK196	DCF221K
LAK197	DCF419K
LAK220	DCF106K
LAK225/S	DCF231K
LAK226	DCF094K
LAK228	DCF094K
LAK229	DCF172K
LAK232	DCF211K
LAK234	DCF420K
LAK239	DCF122K
LAK246	DCF170K
LAK247	DCF080K
LAK248	DCF092K

MAHLE	DENSO
LAK248	DCF450K
LAK250	DCF118K
LAK251	DCF181K
LAK252	DCF453K
LAK278/S	DCF160K
LAK280	DCF127K
LAK292/S	DCF168K
LAK293	DCF236K
LAK295/S	DCF163K
LAK297	DCF448K
LAK307	DCF081K
LAK31	DCF225K
LAK32/1	DCF351K
LAK36	DCF196K
LAK364	DCF119K
LAK37	DCF068K
LAK371	DCF273K
LAK373	DCF201K
LAK410	DCF332K
LAK428/S	DCF073K
LAK436	DCF344K
LAK448	DCF230P
LAK45	DCF050K
LAK46	DCF056K
LAK463	DCF365K
LAK478	DCF053K
LAK485	DCF300K
LAK52	DCF094K
LAK54	DCF072K
LAK54	DCF343K
LAK54/1	DCF352K
LAK56	DCF044K
LAK57	DCF460K
LAK58	DCF056K
LAK62	DCF340K
LAK63	DCF002K
LAK70	DCF347K
LAK73/S	DCF015K
LAK74	DCF198K
LAK75	DCF200K
LAK8	DCF018P
LAK81	DCF495P
LAK93	DCF054K
LAK96	DCF345K
LAKG113/S	DCF457K
LAO 109	DCF382P
LAO109	DCF330P
LAO62	DCF475P

MANN FILTER	DENSO
CU 1009	DCF286P
CU 1719	DCF243P
CU 1738	DCF446P
CU 1827	DCF466P
CU 1828	DCF357P
CU 1830	DCF305P
CU 1910	DCF284P
CU 1912	DCF383P
CU 1915	DCF302P
CU 1919	DCF382P
CU 1919	DCF385K
CU 1936	DCF509P
CU 2012	DCF245P
CU 2026	DCF499P
CU 2027	DCF330P
CU 2028	DCF460P
CU 2035	DCF469P
CU 2043	DCF480P
CU 2047	DCF485P
CU 21001-2	DCF361P
CU 21002-2	DCF326P
CU 2106-2	DCF423P
CU 2131	DCF353P

Cabin Air Filter

Cross Reference Chart - OE

MANN FILTER	DENSO
CU 2138	DCF377P
CU 2141	DCF467P
CU 2149	DCF492P
CU 22 032	DCF386P
CU 22002-2	DCF374P
CU 2224-2	DCF550P
CU 2225	DCF018P
CU 2232	DCF506P
CU 2232/1	DCF506P
CU 2243	DCF488P
CU 2245	DCF540P
CU 2252	DCF467P
CU 2253	DCF109P
CU 23000-2	DCF303P
CU 2316	DCF413P
CU 2326	DCF227P
CU 2326	DCF526P
CU 2330	DCF242P
CU 2331	DCF263P
CU 2335	DCF504P
CU 2338	DCF412P
CU 2344	DCF086P
CU 2349	DCF193P
CU 2356	DCF366P
CU 24 017	DCF388P
CU 24001	DCF380P
CU 2416	DCF285P
CU 2422	DCF497P
CU 2423	DCF411P
CU 2430	DCF414P
CU 2435	DCF270P
CU 2436	DCF489P
CU 2440	DCF465P
CU 2454	DCF473P
CU 2506-2	DCF266P
CU 2513	DCF375P
CU 2521-2	DCF283P
CU 2530	DCF190P
CU 2532	DCF483P
CU 2542-2	DCF268P
CU 2544	DCF454P
CU 2545	DCF462P
CU 2559	DCF471P
CU 26000-2	DCF279P
CU 2622	DCF371P
CU 2628	DCF408P
CU 2640	DCF280P
CU 2645/1	DCF078P
CU 2647	DCF410P
CU 2672	DCF268P
CU 2680	DCF513P
CU 2709	DCF306P
CU 2734	DCF416P
CU 2736-2	DCF402P
CU 2745-2	DCF514P
CU 2747	DCF516P
CU 2750	DCF287P
CU 2757	DCF482P
CU 2839	DCF255P
CU 2842	DCF477P
CU 2855	DCF494P
CU 2882	DCF461P
CU 2897	DCF009P
CU 2939	DCF449P
CU 2940	DCF470P
CU 2945	DCF502P
CU 2949-2	DCF400P
CU 2951	DCF507P
CU 2951/1	DCF042P
CU 2952	DCF368P
CU 3020	DCF083P
CU 3023	DCF522P
CU 3037	DCF463P

MANN FILTER	DENSO
CU 3039-2	DCF479P
CU 3054	DCF476P
CU 3124-2	DCF064P
CU 3139-2	DCF403P
CU 3172/1	DCF145P
CU 3337	DCF481P
CU 3448	DCF493P
CU 3454	DCF418P
CU 3455	DCF031P
CU 3518	DCF405P
CU 3540	DCF521P
CU 3567	DCF474P
CU 3642-2	DCF262P
CU 3780	DCF495P
CU 3822-2	DCF159P
CU 3858	DCF537P
CU 3955	DCF508P
CU 4007/1	DCF142P
CU 4054	DCF452P
CU 4179	DCF532P
CU 4251	DCF541P
CU 4624	DCF061P
CU 5141	DCF517P
CU 5366	DCF475P
CU 5480	DCF500P
CU 6724	DCF016P
CU 8430	DCF096P
CU1 009	DCF286P
CU1 629	DCF565P
CU1 719	DCF243P
CU1 738	DCF446P
CU1 827	DCF466P
CU1 828	DCF357P
CU1 830	DCF305P
CU1 910	DCF284P
CU1 912	DCF383P
CU1 915	DCF302P
CU1 919	DCF382P
CU1 936	DCF509P
CU2 0006	DCF580P
CU2 0013	DCF585P
CU2 012	DCF245P
CU2 026	DCF499P
CU2 027	DCF330P
CU2 028	DCF460P
CU2 035	DCF469P
CU2 043	DCF480P
CU2 047	DCF485P
CU2 1000-2	DCF560P
CU2 1001-2	DCF361P
CU2 1002-2	DCF326P
CU2 1003	DCF573P
CU2 106-2	DCF423P
CU2 131	DCF353P
CU2 138	DCF377P
CU2 141	DCF467P
CU2 149	DCF492P
CU2 2001-2	DCF563P
CU2 2002-2	DCF374P
CU2 2011	DCF579P
CU2 2013	DCF589P
CU2 2022	DCF584P
CU2 2023	DCF590P
CU2 224-2	DCF550P
CU2 225	DCF018P
CU2 232	DCF506P
CU2 232/1	DCF506P
CU2 243	DCF488P
CU2 245	DCF540P
CU2 252	DCF467P
CU2 253	DCF109P
CU2 3000-2	DCF303P
CU2 3009	DCF572P

MANN FILTER	DENSO
CU23010	DCF569P
CU23011	DCF574P
CU2316	DCF413P
CU2317	DCF562P
CU2326	DCF227P
CU2326	DCF526P
CU2330	DCF242P
CU2331	DCF263P
CU2335	DCF504P
CU2338	DCF412P
CU2344	DCF086P
CU2349	DCF193P
CU2356	DCF366P
CU2358	DCF561P
CU24001	DCF380P
CU24004	DCF582P
CU24009	DCF578P
CU24013	DCF577P
CU2416	DCF285P
CU2418-2	DCF568P
CU2422	DCF497P
CU2423	DCF411P
CU2430	DCF414P
CU2435	DCF270P
CU2436	DCF489P
CU2440	DCF465P
CU2442	DCF564P
CU2450	DCF571P
CU2454	DCF473P
CU25001	DCF581P
CU25002	DCF587P
CU25003	DCF588P
CU2506-2	DCF266P
CU2513	DCF375P
CU2521-2	DCF283P
CU2530	DCF190P
CU2532	DCF483P
CU2542-2	DCF268P
CU2544	DCF454P
CU2545	DCF462P
CU2559	DCF471P
CU26000-2	DCF279P
CU26006	DCF583P
CU26009	DCF575P
CU26010	DCF576P
CU2622	DCF371P
CU2628	DCF408P
CU2640	DCF280P
CU2645/1	DCF078P
CU2647	DCF410P
CU2672	DCF268P
CU2680	DCF513P
CU27009	DCF586P
CU2709	DCF306P
CU2733	DCF566P
CU2734	DCF416P
CU2736-2	DCF402P
CU2745-2	DCF514P
CU2747	DCF516P
CU2750	DCF287P
CU2757	DCF482P
CU2839	DCF255P
CU2842	DCF477P
CU2855	DCF494P
CU2882	DCF461P
CU2897	DCF009P
CU29002-2	DCF570P
CU2939	DCF449P
CU2940	DCF470P
CU2945	DCF502P
CU2949-2	DCF400P
CU2951	DCF507P
CU2951/1	DCF042P

MANN FILTER	DENSO
CU2952	DCF368P
CU3020	DCF083P
CU3023	DCF522P
CU3037	DCF463P
CU3039-2	DCF479P
CU3054	DCF476P
CU3124-2	DCF064P
CU3139-2	DCF403P
CU3172/1	DCF145P
CU3337	DCF481P
CU3448	DCF493P
CU3454	DCF418P
CU3455	DCF031P
CU3518	DCF405P
CU3540	DCF521P
CU3567	DCF474P
CU3642-2	DCF262P
CU3780	DCF495P
CU3822-2	DCF159P
CU3858	DCF537P
CU3955	DCF508P
CU4007/1	DCF142P
CU4054	DCF452P
CU4179	DCF532P
CU4251	DCF541P
CU4436	DCF567P
CU4624	DCF061P
CU5141	DCF517P
CU5366	DCF475P
CU5480	DCF500P
CU6724	DCF016P
CU8430	DCF096P
CUK 18000-2	DCF162K
CUK 1820-2	DCF048K
CUK 1830	DCF181K
CUK 1919	DCF385K
CUK 20000-2	DCF161K
CUK 2032	DCF345K
CUK 2033-2	DCF457K
CUK 2131	DCF239K
CUK 2141	DCF344K
CUK 22 032	DCF387K
CUK 2226	DCF384K
CUK 2227	DCF120K
CUK 2230	DCF053K
CUK 2230/1	DCF336K
CUK 2231	DCF300K
CUK 2232	DCF448K
CUK 2241-2	DCF160K
CUK 2243	DCF201K
CUK 2252	DCF273K
CUK 2338	DCF341K
CUK 2339	DCF420K
CUK 2345	DCF389K
CUK 2422	DCF039K
CUK 2433	DCF105K
CUK 2436	DCF365K
CUK 2545	DCF458K
CUK 2559	DCF106K
CUK 2646-2	DCF163K
CUK 2722-2	DCF168K
CUK 2736-2	DCF015K
CUK 2757	DCF198K
CUK 2842	DCF234K
CUK 2855	DCF343K
CUK 2855/1	DCF352K
CUK 2862	DCF002K
CUK 2882	DCF225K
CUK 2939	DCF052K
CUK 2939/1	DCF053K
CUK 2940	DCF071K
CUK 2951	DCF044K
CUK 3023	DCF122K

Cabin Air Filter

Cross Reference Chart - OE

MANN FILTER	DENSO
CUK 3037	DCF054K
CUK 3054	DCF200K
CUK 3124-2	DCF065K
CUK 3137	DCF080K
CUK 3139-2	DCF419K
CUK 3142	DCF067K
CUK 3172	DCF252K
CUK 3192	DCF056K
CUK 3240	DCF211K
CUK 3241	DCF125K
CUK 3337	DCF223K
CUK 3360	DCF351K
CUK 3448	DCF460K
CUK 3461/1	DCF153K
CUK 35000-2	DCF231K
CUK 3518	DCF346K
CUK 3540	DCF172K
CUK 3621	DCF170K
CUK 3780	DCF035K
CUK 3840	DCF221K
CUK 3847	DCF332K
CUK 3955	DCF050K
CUK 4007	DCF164K
CUK 4054	DCF453K
CUK 4136	DCF059K
CUK 4624	DCF063K
CUK 5258	DCF347K
CUK 5366	DCF340K
CUK 5480	DCF094K
CUK 6724	DCF062K
CUK 8430	DCF092K
CUK 8430	DCF450K
CUK18000-2	DCF162K
CUK1820-2	DCF048K
CUK1830	DCF181K
CUK20000-2	DCF161K
CUK2032	DCF345K
CUK2033-2	DCF457K
CUK2131	DCF239K
CUK2141	DCF344K
CUK2227	DCF120K
CUK2230	DCF053K
CUK2230/1	DCF336K
CUK2231	DCF300K
CUK2232	DCF448K
CUK2241-2	DCF160K
CUK2243	DCF201K
CUK2252	DCF273K
CUK2338	DCF341K
CUK2339	DCF420K
CUK2422	DCF039K
CUK2433	DCF105K
CUK2436	DCF365K
CUK2545	DCF458K
CUK2559	DCF106K
CUK2646-2	DCF163K
CUK2722-2	DCF168K
CUK2736-2	DCF015K
CUK2757	DCF198K
CUK2842	DCF234K
CUK2855	DCF343K
CUK2855/1	DCF352K
CUK2862	DCF002K
CUK2882	DCF225K
CUK2939	DCF052K
CUK2939/1	DCF053K
CUK2940	DCF071K
CUK2951	DCF044K
CUK3023	DCF122K
CUK3037	DCF054K
CUK3054	DCF200K
CUK3124-2	DCF065K
CUK3137	DCF080K

MANN FILTER	DENSO
CUK3139-2	DCF419K
CUK3142	DCF067K
CUK3172	DCF252K
CUK3192	DCF056K
CUK3240	DCF211K
CUK3241	DCF125K
CUK3337	DCF223K
CUK3360	DCF351K
CUK3448	DCF460K
CUK3461/1	DCF153K
CUK35000-2	DCF231K
CUK3518	DCF346K
CUK3540	DCF172K
CUK3621	DCF170K
CUK3780	DCF035K
CUK3840	DCF221K
CUK3847	DCF332K
CUK3955	DCF050K
CUK4007	DCF164K
CUK4054	DCF453K
CUK4136	DCF059K
CUK4624	DCF063K
CUK5258	DCF347K
CUK5366	DCF340K
CUK5480	DCF094K
CUK6724	DCF062K
CUK8430	DCF092K
CUK8430	DCF450K

MAPCO	DENSO
65006	DCF536P
65007	DCF507P
65009	DCF083P
65011	DCF504P
65012	DCF083P
65012	DCF497P
65013	DCF580P
65014	DCF485P
65109	DCF502P
65111	DCF502P
65112	DCF416P
65113	DCF270P
65117	DCF492P
65118	DCF413P
65202	DCF461P
65203	DCF268P
65204	DCF508P
65205	DCF500P
65207	DCF446P
65217	DCF463P
65218	DCF400P
65219	DCF462P
65221	DCF571P
65309	DCF493P
65406	DCF018P
65410	DCF513P
65411	DCF540P
65415	DCF405P
65416	DCF562P
65417	DCF479P
65430	DCF560P
65431	DCF454P
65471	DCF284P
65473	DCF582P
65504	DCF512P
65505	DCF466P
65506	DCF561P
65508	DCF255P
65509	DCF473P
65525	DCF190P
65527	DCF190P
65530	DCF467P
65533	DCF418P

MAPCO	DENSO
65535	DCF306P
65536	DCF303P
65540	DCF480P
65544	DCF563P
65545	DCF377P
65550	DCF357P
65551	DCF353P
65554	DCF383P
65555	DCF361P
65557	DCF469P
65559	DCF353P
65560	DCF353P
65560	DCF354P
65561	DCF382P
65570	DCF075P
65571	DCF076P
65573	DCF242P
65575	DCF486P
65576	DCF410P
65577	DCF366P
65578	DCF210P
65578	DCF408P
65579	DCF266P
65582	DCF374P
65584	DCF509P
65600	DCF517P
65603	DCF096P
65603	DCF517P
65605	DCF474P
65607	DCF480P
65608	DCF471P
65609	DCF499P
65614	DCF402P
65615	DCF016P
65618	DCF096P
65620	DCF061P
65621	DCF567P
65701	DCF541P
65702	DCF031P
65709	DCF476P
65710	DCF482P
65711	DCF227P
65711	DCF526P
65712	DCF486P
65713	DCF486P
65715	DCF488P
65716	DCF510P
65717	DCF371P
65800	DCF522P
65801	DCF449P
65802/2	DCF159P
65806	DCF514P
65808	DCF412P
65809	DCF009P
65811	DCF477P
65814	DCF583P
65857	DCF144P
65860	DCF521P
65861	DCF568P
65884	DCF452P
67001	DCF044K
67101	DCF221K
67102	DCF332K
67202	DCF002K
67202	DCF225K
67205	DCF094K
67206	DCF196K
67208	DCF002K
67217	DCF054K
67219	DCF458K
67221	DCF200K
67231	DCF081K
67241	DCF576P

MAPCO	DENSO
67302	DCF073K
67309	DCF460K
67414	DCF071K
67419	DCF346K
67421	DCF211K
67552	DCF385K
67585	DCF053K
67606	DCF106K
67607	DCF105K
67608	DCF365K
67609	DCF589P
67614	DCF015K
67615	DCF062K
67618	DCF450K
67619	DCF419K
67622	DCF340K
67626	DCF581P
67636	DCF236K
67709	DCF198K
67710	DCF201K
67713	DCF223K
67715	DCF199K
67801	DCF052K
67801	DCF053K
67802	DCF122K
67803	DCF035K
67807	DCF152K
67808	DCF163K
67809	DCF068K
67811	DCF234K
67852	DCF072K
67852	DCF343K
67881	DCF252K
67883	DCF162K
67883	DCF252K
67884	DCF453K
67885	DCF161K
67886	DCF153K
67901	DCF181K

MECAFILTER	DENSO
CLR7120	DCF090K
EKR7002	DCF196K
EKR7004	DCF002K
EKR7004	DCF225K
EKR7005	DCF050K
EKR7009	DCF094K
EKR7019	DCF044K
EKR7023	DCF068K
EKR7027	DCF351K
EKR7038	DCF056K
EKR7040	DCF200K
EKR7049	DCF198K
EKR7068	DCF460K
EKR7073	DCF035K
EKR7074	DCF341K
EKR7076	DCF458K
EKR7081	DCF164K
EKR7092	DCF054K
EKR7097	DCF071K
EKR7098	DCF062K
EKR7104	DCF346K
EKR7106	DCF223K
EKR7108	DCF340K
EKR7117	DCF072K
EKR7118	DCF343K
EKR7123	DCF221K
EKR7127	DCF052K
EKR7128	DCF236K
EKR7129	DCF234K
EKR7130	DCF105K
EKR7131	DCF199K

Cabin Air Filter

Cross Reference Chart - OE

MECAFILTER	DENSO
EKR7132	DCF172K
EKR7135	DCF067K
EKR7136	DCF347K
EKR7137	DCF453K
EKR7142	DCF063K
EKR7145	DCF106K
EKR7146	DCF252K
EKR7148	DCF053K
EKR7149	DCF059K
EKR7151	DCF450K
EKR7159	DCF239K
EKR7159	DCF384K
EKR7162	DCF211K
EKR7163	DCF420K
EKR7165	DCF125K
EKR7166	DCF448K
EKR7172	DCF170K
EKR7187	DCF201K
EKR7193	DCF181K
EKR7212	DCF385K
EKR7218	DCF332K
EKR7225	DCF345K
EKR7228	DCF081K
EKR7235	DCF300K
EKR7245	DCF365K
EKR7280	DCF120K
ELR7000	DCF541P
ELR7001	DCF031P
ELR7004	DCF461P
ELR7005	DCF508P
ELR7009	DCF500P
ELR7017	DCF018P
ELR7018	DCF536P
ELR7019	DCF042P
ELR7019	DCF507P
ELR7023	DCF009P
ELR7040	DCF476P
ELR7044	DCF446P
ELR7045	DCF416P
ELR7047	DCF502P
ELR7048	DCF270P
ELR7049	DCF482P
ELR7051	DCF109P
ELR7052	DCF075P
ELR7053	DCF076P
ELR7055	DCF474P
ELR7061	DCF083P
ELR7068	DCF493P
ELR7075	DCF513P
ELR7076	DCF462P
ELR7077	DCF537P
ELR7079	DCF042P
ELR7081	DCF141P
ELR7092	DCF463P
ELR7093	DCF227P
ELR7093	DCF526P
ELR7095	DCF492P
ELR7096	DCF517P
ELR7098	DCF016P
ELR7099	DCF193P
ELR7100	DCF190P
ELR7103	DCF418P
ELR7104	DCF405P
ELR7105	DCF540P
ELR7106	DCF486P
ELR7108	DCF475P
ELR7117	DCF532P
ELR7119	DCF497P
ELR7120	DCF504P
ELR7122	DCF357P
ELR7124	DCF413P
ELR7127	DCF449P
ELR7128	DCF465P

MECAFILTER	DENSO
ELR7129	DCF477P
ELR7131	DCF510P
ELR7132	DCF521P
ELR7142	DCF061P
ELR7143	DCF499P
ELR7144	DCF466P
ELR7145	DCF471P
ELR7146	DCF144P
ELR7151	DCF096P
ELR7154	DCF354P
ELR7159	DCF353P
ELR7164	DCF469P
ELR7166	DCF506P
ELR7168	DCF480P
ELR7173	DCF561P
ELR7174	DCF516P
ELR7180	DCF366P
ELR7181	DCF410P
ELR7182	DCF210P
ELR7182	DCF408P
ELR7183	DCF287P
ELR7185	DCF454P
ELR7187	DCF488P
ELR7194	DCF309P
ELR7195	DCF473P
ELR7198	DCF243P
ELR7199	DCF242P
ELR7206	DCF486P
ELR7208	DCF230P
ELR7208	DCF375P
ELR7212	DCF382P
ELR7213	DCF562P
ELR7214	DCF383P
ELR7216	DCF255P
ELR7219	DCF509P
ELR7220	DCF571P
ELR7221	DCF466P
ELR7227	DCF467P
ELR7236	DCF566P
ELR7252	DCF245P
ELR7254	DCF284P
ELR7260	DCF263P
ELR7261	DCF483P
ELR7263	DCF564P
ELR7264	DCF460P
ELR7267	DCF377P
ELR7272	DCF565P
ELR7273	DCF485P
ELR7274	DCF567P
ELR7279	DCF302P
ELR7285	DCF589P
ELR7288	DCF371P
ELR7291	DCF575P
ELR7292	DCF587P
ELR7295	DCF579P
ELR7299	DCF576P
ELR7304	DCF581P
ELR7308	DCF580P
ELR7309	DCF583P
ELR7311	DCF582P
ELR7312	DCF569P
ELR7313	DCF584P
ELR7318	DCF573P
ELR7319	DCF577P
ELR7328	DCF578P
ELR7332	DCF574P
ELR7338	DCF588P
ELR7343	DCF585P
ELR7346	DCF388P
JKR7015	DCF015K
JKR7086	DCF161K
JKR7090	DCF048K
JKR7121	DCF065K

MECAFILTER	DENSO
JKR7133	DCF162K
JKR7158	DCF122K
JKR7161	DCF419K
JKR7201	DCF163K
JKR7234	DCF073K
JLR7015	DCF402P
JLR7039	DCF550P
JLR7080	DCF159P
JLR7087	DCF514P
JLR7091	DCF400P
JLR7121	DCF064P
JLR7152	DCF512P
JLR7158	DCF522P
JLR7160	DCF187P
JLR7161	DCF403P
JLR7205	DCF563P
JLR7209	DCF374P
JLR7210	DCF361P
JLR7217	DCF560P
JLR7229	DCF266P
JLR7234	DCF479P
JLR7243	DCF568P
JLR7253	DCF268P
JLR7301	DCF570P
JLR7329	DCF303P

MEYLE	DENSO
012 319 0001	DCF009P
012 319 0005/S	DCF159P
012 319 0006	DCF144P
012 319 0007	DCF145P
012 319 0008	DCF141P
012 319 0009	DCF142P
012 319 0011/S	DCF514P
012 319 0013	DCF521P
012 319 0014	DCF537P
012 319 0016	DCF412P
012 319 0029	DCF452P
012 320 0001	DCF068K
012 320 0003	DCF152K
012 320 0004	DCF153K
012 320 0006	DCF252K
012 320 0008	DCF164K
012 320 0010	DCF035K
012 320 0012/S	DCF161K
012 320 0013	DCF172K
012 320 0016	DCF412P
012 320 0017	DCF170K
012 320 0018	DCF345K
012 320 0019	DCF181K
012 320 0021/S	DCF162K
012 320 0022/S	DCF160K
012 320 0028/S	DCF163K
012 320 0029	DCF453K
012 320 0038	DCF081K
014 320 0000/S	DCF168K
11-12 319 0001	DCF493P
11-12 319 0010	DCF479P
11-12 319 0014	DCF454P
11-12 320 0000	DCF071K
11-12 320 0001	DCF460K
11-12 320 0004	DCF351K
11-12 320 0006	DCF347K
11-12 320 0010	DCF073K
11-12 320 0012	DCF332K
11-12 320 0014	DCF454P
11-123190008/S	DCF560P
11-123190009	DCF562P
112 319 0001	DCF461P
112 319 0002	DCF508P
112 319 0003	DCF462P
112 319 0004	DCF463P
112 319 0006/S	DCF400P

MEYLE	DENSO
112 319 0008	DCF500P
112 319 0009	DCF446P
112 319 0011	DCF449P
112 319 0012	DCF477P
112 319 0015/S	DCF522P
112 320 0001	DCF225K
112 320 0002	DCF050K
112 320 0003	DCF458K
112 320 0004	DCF054K
112 320 0008	DCF094K
112 320 0010	DCF056K
112 320 0011	DCF052K
112 320 0012	DCF234K
112 320 0015/S	DCF122K
112 320 0016	DCF059K
112 320 0018/S	DCF231K
112 320 1001	DCF002K
1123190020	DCF571P
1123190021	DCF583P
1123190023	DCF576P
1123190025	DCF575P
1123200019	DCF053K
123190040	DCF587P
15-12 319 0000	DCF506P
15-12 320 0000	DCF448K
15-12 320 0000/S	DCF048K
16-12 319 0001	DCF502P
16-12 319 0006	DCF492P
16-12 319 0010	DCF413P
16-12 319 0012	DCF416P
16-12 320 0001	DCF502P
16-12 320 0004	DCF221K
16-123190019/S	DCF568P
16-123190022	DCF565P
16-123190023	DCF579P
16-123190027	DCF586P
18-12 320 0000	DCF118K
212 319 0001	DCF042P
212 319 0001	DCF507P
212 319 0004	DCF536P
212 319 0006	DCF504P
212 319 0007	DCF083P
212 319 0014	DCF450K
212 320 0005	DCF090K
212 320 0012	DCF485P
2123190012	DCF485P
2123190016	DCF580P
2123190017	DCF584P
214 319 0000	DCF499P
28-12 319 0002	DCF280P
28-12 319 0003/S	DCF283P
28-12 319 0008/S	DCF279P
28-123190005	DCF569P
28-123190009	DCF582P
29-12 319 0000	DCF242P
29-12 319 0001	DCF076P
29-12 319 0001	DCF078P
29-12 319 0003	DCF075P
29-12 319 0005	DCF245P
29-12 319 0007	DCF243P
30-12 319 0001	DCF357P
30-12 319 0002/S	DCF361P
30-12 319 0003	DCF469P
30-12 319 0005	DCF353P
30-12 319 0005	DCF384K
30-12 319 0006	DCF382P
30-12 319 0013	DCF383P
30-12 320 0005	DCF239K
30-12 320 0005	DCF384K
30-12 320 0006	DCF382P
30-12 320 0006	DCF385K
30-12 324 0006	DCF382P
30-12 324 0006	DCF385K

Cabin Air Filter

Cross Reference Chart - OE

MEYLE	DENSO
30-123190016	DCF585P
31-12 319 0001	DCF255P
31-12 319 0004/S	DCF512P
31-12 319 0005	DCF109P
31-12 319 0006	DCF466P
31-12 319 0009	DCF473P
31-12 320 0006	DCF466P
31-12 320 0009	DCF473P
31-123190008	DCF561P
31-123190010	DCF573P
312 319 0002	DCF016P
312 319 0004/S	DCF402P
312 319 0005/S	DCF262P
312 319 0007/S	DCF403P
312 319 0012/S	DCF064P
312 319 0012/S	DCF475P
312 319 0013	DCF475P
312 319 0015	DCF096P
312 320 0002	DCF062K
312 320 0004/S	DCF015K
312 320 0006	DCF420K
312 320 0007/S	DCF419K
312 320 0009	DCF063K
312 320 0012/S	DCF065K
312 320 0013	DCF340K
312 320 0014	DCF063K
312 320 0015	DCF450K
3123190009	DCF567P
3123190021	DCF581P
32-12 319 0000/S	DCF302P
32-12 319 0000/S	DCF303P
32-12 319 0002	DCF467P
32-12 319 0003	DCF300K
32-12 319 0004	DCF306P
32-12 319 0005	DCF309P
32-12 319 0006	DCF053K
32-12 320 0001	DCF053K
32-12 320 0002	DCF344K
32-12 320 0003	DCF300K
32-12 320 0004	DCF336K
33-12 319 0002	DCF230P
33-12 319 0002	DCF375P
33-12 319 0003/S	DCF374P
33-12 319 0004	DCF377P
33-12 319 0005	DCF376P
33-12 319 0007	DCF330P
33-12 320 0002	DCF230P
33-12 320 0002	DCF375P
33-12 320 0003/S	DCF374P
33-12 320 0004	DCF377P
34-12 319 0004/S	DCF326P
34-123190001	DCF590P
35-12 319 0000	DCF480P
35-12 319 0003	DCF295P
35-12 320 0001/S	DCF457K
35-123190008/S	DCF563P
35-123190011	DCF578P
36-12 319 0000	DCF467P
36-12 319 0005	DCF509P
36-12 319 0006	DCF467P
36-12 319 0007/S	DCF187P
36-12 320 0000	DCF188K
36-12 320 0005	DCF509P
36-123190010	DCF574P
36-123190012	DCF588P
37-12 319 0000	DCF210P
37-12 319 0000	DCF408P
37-12 319 0001	DCF366P
37-12 319 0002	DCF410P
37-12 319 0003/S	DCF266P
37-12 319 0007	DCF263P
37-12 319 0008	DCF284P
37-12 319 0009	DCF483P

MEYLE	DENSO
37-12 319 0010	DCF486P
37-12 319 0014/S	DCF268P
37-12 320 0007	DCF263P
37-12 320 0009	DCF483P
37-12 320 0010	DCF486P
37-123190006/S	DCF570P
37-123190015	DCF582P
40-12 319 0000	DCF018P
40-12 319 0001	DCF540P
40-12 319 0004	DCF532P
40-12 319 0006	DCF513P
40-12 320 0002	DCF346K
40-12 320 0003	DCF211K
40-12 320 0004	DCF072K
44-12 319 0002	DCF067K
44-12 320 0002	DCF067K
512 320 0000	DCF072K
512 320 0000	DCF343K
512 320 0003	DCF352K
53-12 319 0001	DCF286P
53-12 319 0002	DCF516P
53-12 320 0002	DCF127K
612 319 0001	DCF541P
612 319 0002	DCF482P
612 319 0003	DCF476P
612 319 0004	DCF031P
612 319 0005	DCF486P
612 319 0010	DCF227P
612 319 0010	DCF526P
612 319 0012	DCF510P
612 319 0015	DCF418P
612 319 0016	DCF488P
612 319 0017	DCF371P
612 319 0018	DCF460P
612 320 0002	DCF198K
612 320 0003	DCF200K
612 320 0005	DCF223K
612 320 0012	DCF199K
612 320 0015	DCF526P
612 320 0016	DCF201K
6123190013	DCF564P
712 319 0002	DCF517P
712 319 0003	DCF096P
712 319 0004	DCF474P
712 319 0006	DCF471P
712 319 0008	DCF190P
712 319 0010	DCF465P
712 320 0005	DCF105K
712 320 0006	DCF106K
712 320 0010	DCF236K
712 320 0011	DCF365K
7123190012	DCF589P
MCF0286	DCF590P

MISFAT	DENSO
HB178	DCF562P
HB181	DCF560P
HB194	DCF571P
HB195C	DCF384K
HB198	DCF382P
HB198C	DCF385K
HB207	DCF564P
HB224	DCF565P
HB231	DCF568P
HB238	DCF567P
HB245	DCF589P
HB249	DCF383P
HB252	DCF575P
HB255	DCF587P
HB265	DCF581P
HB269	DCF578P
HB294	DCF573P
HB295	DCF569P

MISFAT	DENSO
HB296	DCF577P
HB302	DCF574P
HB303	DCF588P
HB306	DCF388P
HB332C	DCF387K

MULLER FILTER	DENSO
FC001	DCF357P
FC103	DCF507P
FC103R	DCF042P
FC110	DCF462P
FC110	DCF576P
FC111	DCF461P
FC115x2	DCF522P
FC116	DCF508P
FC117	DCF463P
FC118	DCF449P
FC120	DCF018P
FC122	DCF513P
FC123	DCF540P
FC126	DCF532P
FC128x2	DCF479P
FC129	DCF454P
FC131	DCF061P
FC133	DCF096P
FC134x2	DCF064P
FC134x2	DCF475P
FC137	DCF286P
FC141	DCF504P
FC142	DCF083P
FC144	DCF083P
FC144	DCF497P
FC145	DCF536P
FC147	DCF499P
FC147	DCF580P
FC148	DCF488P
FC149	DCF572P
FC150	DCF096P
FC150	DCF517P
FC152	DCF474P
FC153	DCF500P
FC154	DCF517P
FC159	DCF009P
FC162R	DCF467P
FC165	DCF412P
FC166	DCF305P
FC170	DCF227P
FC170	DCF526P
FC171	DCF476P
FC172	DCF482P
FC173	DCF541P
FC174	DCF031P
FC176	DCF486P
FC178	DCF510P
FC180	DCF493P
FC186	DCF562P
FC188x2	DCF560P
FC190	DCF502P
FC192	DCF416P
FC196	DCF492P
FC199	DCF270P
FC202	DCF353P
FC202	DCF384K
FC203	DCF586P
FC204	DCF469P
FC205	DCF382P
FC205	DCF385K
FC208	DCF485P
FC216	DCF268P
FC217	DCF446P
FC218	DCF477P
FC219x2	DCF400P
FC222	DCF405P

MULLER FILTER	DENSO
FC229	DCF255P
FC231	DCF190P
FC236	DCF016P
FC237x2	DCF402P
FC238x2	DCF403P
FC252	DCF465P
FC253	DCF471P
FC257	DCF480P
FC258	DCF452P
FC259	DCF144P
FC260x2	DCF514P
FC261	DCF480P
FC262	DCF537P
FC263	DCF521P
FC265x2	DCF563P
FC268	DCF302P
FC271	DCF585P
FC275	DCF588P
FC281	DCF230P
FC281	DCF375P
FC282x2	DCF374P
FC291	DCF353P
FC291	DCF354P
FC295	DCF413P
FC296	DCF502P
FC297x2	DCF568P
FC305	DCF371P
FC317	DCF571P
FC321	DCF075P
FC322	DCF076P
FC323	DCF242P
FC330	DCF389K
FC333	DCF467P
FC336	DCF516P
FC340	DCF284P
FC341	DCF280P
FC343	DCF486P
FC344x2	DCF268P
FC345	DCF410P
FC347	DCF366P
FC348x2	DCF266P
FC351	DCF109P
FC352x2	DCF512P
FC354	DCF466P
FC355	DCF466P
FC356	DCF561P
FC359	DCF564P
FC360	DCF460P
FC361	DCF210P
FC361	DCF408P
FC362x2	DCF283P
FC363	DCF467P
FC365	DCF590P
FC366	DCF263P
FC366	DCF577P
FC367	DCF483P
FC372x2	DCF279P
FC375	DCF411P
FC377x2	DCF187P
FC378	DCF509P
FC380	DCF326P
FC381	DCF330P
FC384x2	DCF361P
FC385x2	DCF285P
FC386	DCF566P
FC388	DCF567P
FC389x2	DCF303P
FC390	DCF418P
FC394x2	DCF423P
FC396	DCF306P
FC398x2	DCF570P
FC400	DCF582P
FC405x2	DCF159P

Cabin Air Filter

Cross Reference Chart - OE

MULLER FILTER	DENSO
FC408	DCF565P
FC411	DCF376P
FC412	DCF377P
FC414	DCF383P
FC415	DCF573P
FC416	DCF569P
FC427	DCF584P
FC429	DCF380P
FC434	DCF589P
FC435	DCF471P
FC436	DCF578P
FC438	DCF587P
FC440	DCF581P
FC455	DCF473P
FC457	DCF243P
FC466	DCF574P
FC472	DCF386P
FC472	DCF387K
FC480	DCF245P
FC485	DCF575P
FC486	DCF576P
FC489	DCF388P
FC511	DCF579P
FK001	DCF239K
FK102x2	DCF048K
FK103	DCF044K
FK110	DCF458K
FK111	DCF002K
FK111	DCF225K
FK112	DCF002K
FK115x2	DCF122K
FK116	DCF050K
FK117	DCF054K
FK118	DCF052K
FK118R	DCF053K
FK128x2	DCF073K
FK131	DCF063K
FK133	DCF450K
FK136	DCF340K
FK143	DCF090K
FK144	DCF450K
FK148	DCF201K
FK155	DCF105K
FK156	DCF094K
FK159	DCF068K
FK160	DCF035K
FK161	DCF152K
FK163	DCF345K
FK165	DCF341K
FK166	DCF181K
FK167x2	DCF163K
FK168	DCF170K
FK176	DCF223K
FK180	DCF460K
FK182	DCF351K
FK183	DCF071K
FK185	DCF211K
FK218	DCF234K
FK220	DCF059K
FK236	DCF062K
FK237x2	DCF015K
FK238x2	DCF419K
FK252	DCF236K
FK253	DCF106K
FK258	DCF453K
FK259	DCF252K
FK263	DCF172K
FK264	DCF081K
FK266	DCF300K
FK288	DCF382P
FK288	DCF385K
FK312	DCF072K
FK312	DCF343K

MULLER FILTER	DENSO
FK376x2	DCF168K
FK383x2	DCF231K
FK392	DCF080K
FK445	DCF053K
FK456	DCF118K
FK458	DCF120K
FK472	DCF386P
FK472	DCF387K

NIPPARTS	DENSO
J1340301	DCF283P
J1340301	DCF285P
J1340302	DCF280P
J1340304	DCF279P
J1340305	DCF284P
J1340307	DCF283P
J1340308	DCF483P
J1340500	DCF410P
J1340501	DCF408P
J1340503	DCF366P
J1340504	DCF266P
J1340507	DCF486P
J1340508	DCF268P
J1340902	DCF076P
J1340903	DCF075P
J1340906	DCF242P
J1340910	DCF243P
J1340911	DCF371P
J1341003	DCF190P
J1341011	DCF368P
J1341014	DCF418P
J1341016	DCF389K
J1341016	DCF467P
J1341017	DCF502P
J1341018	DCF509P
J1342000	DCF361P
J1342001	DCF357P
J1342005	DCF354P
J1342010	DCF354P
J1342012	DCF383P
J1342016	DCF239K
J1342016	DCF384K
J1342017	DCF469P
J1342018	DCF239K
J1342018	DCF353P
J1342018	DCF384K
J1342023	DCF383P
J1342024	DCF562P
J1342027	DCF382P
J1342028	DCF382P
J1343001	DCF295P
J1343005	DCF457K
J1343010	DCF480P
J1343017	DCF563P
J1344001	DCF255P
J1344004	DCF109P
J1344007	DCF466P
J1344012	DCF512P
J1344013	DCF473P
J1344014	DCF561P
J1345001	DCF303P
J1345002	DCF309P
J1345003	DCF306P
J1345006	DCF053K
J1345007	DCF423P
J1345008	DCF300K
J1345009	DCF181K
J1345009	DCF305P
J1347001	DCF326P
J1348000	DCF374P
J1348001	DCF526P
J1348002	DCF330P
J1348003	DCF375P

NIPPARTS	DENSO
J1348004	DCF466P
J1348006	DCF377P
N1340310	DCF569P
N1340511	DCF263P
N1340511	DCF577P
N1340512	DCF582P
N1340513	DCF570P
N1340912	DCF245P
N1340913	DCF564P
N1341020	DCF376P
N1341023	DCF565P
N1341025	DCF574P
N1341029	DCF568P
N1341035	DCF588P
N1342037	DCF332K
N1342038	DCF585P
N1342042	DCF386P
N1343019	DCF480P
N1343020	DCF563P
N1343023	DCF578P
N1344015	DCF573P
N1345010	DCF344K
N1345010	DCF467P
N1345011	DCF336K
N1348007	DCF460P
N1348009	DCF380P
N1348012	DCF590P
N1348013	DCF381P

OMNICRAFT	DENSO
2135484	DCF561P
2135488	DCF562P
2135490	DCF382P
2135494	DCF565P
2135498	DCF566P
2135500	DCF567P
2135510	DCF571P
2135518	DCF576P
2135520	DCF577P
2135522	DCF580P
2135524	DCF581P
2135526	DCF582P
2135528	DCF583P
2135545	DCF560P
2135551	DCF563P
2135557	DCF568P
2144614	DCF564P
2144622	DCF575P
2144630	DCF579P
2144686	DCF570P
2144690	DCF573P
2144704	DCF574P
2144710	DCF569P
2144728	DCF572P
2144744	DCF584P
2144754	DCF578P

OPEN PARTS	DENSO
CAF2005.01	DCF382P
CAF2005.11	DCF382P
CAF2005.11	DCF385K
CAF2006.01	DCF562P
CAF2058.02	DCF560P
CAF2100.01	DCF567P
CAF2102.11	DCF384K
CAF2126.01	DCF566P
CAF2130.01	DCF561P
CAF2178.02	DCF563P
CAF2191.01	DCF382P
CAF2201.01	DCF571P
CAF2205.01	DCF564P
CAF2222.02	DCF568P
CAF2237.01	DCF565P

OPEN PARTS	DENSO
CAF2241.01	DCF383P
CAF2242.01	DCF573P
CAF2245.01	DCF569P
CAF2247.02	DCF563P
CAF2250.02	DCF570P
CAF2256.01	DCF580P
CAF2261.01	DCF586P
CAF2267.01	DCF589P
CAF2269.01	DCF582P
CAF2270.01	DCF581P
CAF2271.01	DCF587P
CAF2272.01	DCF583P
CAF2273.01	DCF576P
CAF2276.01	DCF575P
CAF2284.01	DCF584P
CAF2285.01	DCF574P
CAF2287.01	DCF578P
CAF2288.01	DCF588P
CAF2295.01	DCF585P
CAF2297.01	DCF579P
CAF2302.01	DCF577P

PARTS-MALL	DENSO
PM1-009	DCF199K
PM1-009	DCF510P
PM1-016	DCF476P
PM1-C09	DCF199K
PM1-C09	DCF510P
PM2-026	DCF474P
PM2-028	DCF105K
PM2-029	DCF471P
PM2-030	DCF106K
PM2-031	DCF236K
PM2-032	DCF365K
PM2-C15	DCF517P
PM2-C26	DCF474P
PM2-C32	DCF365K
PM7-001	DCF340K
PM7-002	DCF127K
PMA-001	DCF410P
PMA-002	DCF408P
PMA-004	DCF366P
PMA-011	DCF486P
PMA-012	DCF266P
PMA-020	DCF263P
PMA-021	DCF268P
PMA-022	DCF582P
PMA-024	DCF577P
PMA-040	DCF570P
PMA-C01	DCF410P
PMA-C02	DCF408P
PMA-C04	DCF366P
PMA-C11	DCF486P
PMA-C12	DCF266P
PMA-C20	DCF263P
PMA-C21	DCF268P
PMA-C22	DCF582P
PMA-C24	DCF577P
PMA-C40	DCF570P
PMA-P01	DCF410P
PMA-P02	DCF408P
PMA-P04	DCF366P
PMA-P11	DCF486P
PMA-P12	DCF266P
PMA-P20	DCF263P
PMA-P21	DCF268P
PMA-P22	DCF582P
PMA-P24	DCF577P
PMB-001	DCF280P
PMB-004	DCF279P
PMB-007	DCF283P
PMB-007	DCF285P
PMB-010	DCF283P

Cabin Air Filter

Cross Reference Chart - OE

PARTS-MALL	DENSO
PMB-011	DCF410P
PMB-012	DCF410P
PMB-015	DCF483P
PMB-016	DCF284P
PMB-C01	DCF280P
PMB-C04	DCF279P
PMB-C07	DCF283P
PMB-C07	DCF285P
PMB-C10	DCF283P
PMB-C11	DCF410P
PMB-C12	DCF410P
PMB-C15	DCF483P
PMB-C16	DCF284P
PMB-P01	DCF280P
PMB-P04	DCF279P
PMB-P07	DCF283P
PMB-P07	DCF285P
PMB-P10	DCF283P
PMB-P11	DCF410P
PMB-P12	DCF410P
PMB-P16	DCF284P
PMC-001	DCF076P
PMC-002	DCF075P
PMC-003	DCF243P
PMC-006	DCF242P
PMC-009	DCF245P
PMC-012	DCF371P
PMC-C01	DCF076P
PMC-C02	DCF075P
PMC-C03	DCF243P
PMC-C06	DCF242P
PMC-C12	DCF371P
PMC-P01	DCF076P
PMC-P02	DCF075P
PMC-P03	DCF243P
PMC-P06	DCF242P
PMC-P12	DCF371P
PME-009	DCF579P
PME-C09	DCF579P
PMF-003	DCF357P
PMF-004	DCF239K
PMF-018	DCF469P
PMF-077	DCF382P
PMF-077	DCF385K
PMF-078	DCF383P
PMF-079	DCF562P
PMF-081	DCF382P
PMF-081(E)	DCF382P
PMF-083	DCF239K
PMF-088	DCF389K
PMF-C77	DCF385K
PMF-C81	DCF382P
PMF-C88	DCF389K
PMG-007	DCF300K
PMG-012	DCF309P
PMG-014	DCF181K
PMG-016	DCF467P
PMH-009	DCF480P
PMH-022	DCF295P
PMJ-007	DCF109P
PMJ-012	DCF466P
PMJ-032	DCF512P
PMJ-034	DCF255P
PMJ-037	DCF573P
PMJ-038	DCF473P
PMJ-039	DCF561P
PMJ-C34	DCF255P
PMM-004	DCF375P
PMM-005	DCF374P
PMM-015	DCF330P
PMM-016	DCF377P
PMP-013	DCF223K
PMP-013	DCF486P

PARTS-MALL	DENSO
PMP-028	DCF461P
PMP-028(E)	DCF461P
PMP-C11	DCF223K
PMP-C11	DCF486P
PMR-001	DCF009P
PMR-001	DCF068K
PMR-001(E)	DCF068K
PMR-007(E)	DCF144P
PMR-011	DCF341K
PMR-011	DCF412P
PMR-011(E)	DCF341K
PMR-011(E)	DCF412P
PMR-019	DCF152K
PMR-020	DCF035K
PMR-025	DCF144P
PMR-025	DCF252K
PMR-026	DCF163K
PMR-026(E)	DCF163K
PMR-027	DCF168K
PMR-027(E)	DCF168K
PMR-029	DCF170K
PMR-030	DCF453K
PMR-030(E)	DCF453K
PMR-033	DCF514P
PMR-033(E)	DCF514P
PMR-035	DCF521P
PMR-036	DCF081K
PMR-038	DCF537P
PMR-039	DCF161K
PMR-C16	DCF068K
PMR-C20	DCF035K
PMR-C30	DCF453K
PMR-C38	DCF537P
PMT-004	DCF052K
PMT-004	DCF449P
PMT-004(E)	DCF052K
PMT-004(E)	DCF449P
PMT-015	DCF122K
PMT-015(E)	DCF122K
PMT-021	DCF002K
PMT-021	DCF225K
PMT-022	DCF002K
PMT-022(E)	DCF002K
PMT-023	DCF268P
PMT-025	DCF458K
PMT-026	DCF462P
PMT-028	DCF477P
PMT-028(E)	DCF477P
PMT-029	DCF094K
PMT-030(E)	DCF059K
PMT-C07	DCF002K
PMT-C07	DCF225K
PMT-C10	DCF056K
PMV-004	DCF015K
PMV-004	DCF402P
PMV-008	DCF016P
PMV-008(E)	DCF016P
PMV-019	DCF420K
PMV-023	DCF403P
PMV-023	DCF419K
PMV-023(E)	DCF403P
PMV-023(E)	DCF419K
PMV-025	DCF096P
PMV-025	DCF450K
PMV-025(E)	DCF096P
PMV-025(E)	DCF450K
PMV-026	DCF475P
PMV-026(E)	DCF475P
PMV-027	DCF402P
PMV-027(E)	DCF402P
PMV-028	DCF015K
PMV-029	DCF065K
PMV-029(E)	DCF065K

PARTS-MALL	DENSO
PMV-030	DCF567P
PMV-030(E)	DCF567P
PMV-033	DCF262P
PMV-033(E)	DCF262P
PMV-C33	DCF262P
PMW-013	DCF190P
PMW-020	DCF187P
PMW-046	DCF502P
PMW-047	DCF467P
PMW-048	DCF509P
PMW-049	DCF509P
PMW-050	DCF565P
PMW-053	DCF568P
PMW-055	DCF574P
PMW-C13	DCF190P
PMW-C53	DCF568P
PMW-C55	DCF574P
PMX-002D	DCF067K
PMX-002L	DCF493P
PMX-002L(E)	DCF493P
PMX-003G	DCF536P
PMX-004T	DCF508P
PMX-006G	DCF532P
PMX-008U	DCF072K
PMX-008U	DCF343K
PMX-009Z	DCF071K
PMX-010Z	DCF018P
PMX-010Z	DCF540P
PMX-013T	DCF463P
PMX-013T(E)	DCF463P
PMX-015T	DCF054K
PMX-020T	DCF287P
PMX-021T	DCF231K
PMX-023T	DCF234K
PMX-086Y	DCF565P
PMX-088Z	DCF201K
PMX-088Z	DCF488P
PMX-090L	DCF071K
PMX-091Z	DCF479P
PMX-095X	DCF351K
PMX-096Z	DCF211K
PMX-098L	DCF560P
PMX-098L(E)	DCF560P
PMX-098X	DCF118K
PMX-101X	DCF119K
PMX-105G	DCF083P
PMX-105G	DCF450K
PMX-105G	DCF497P
PMX-106T	DCF400P
PMX-107T	DCF056K
PMX-107T(E)	DCF056K
PMX-108Z	DCF332K
PMX-C008U	DCF072K
PMX-C008U	DCF343K
PMX-C02L	DCF493P
PMX-C06G	DCF532P
PMX-C09T	DCF268P
PMX-C101X	DCF119K
PMX-C105G	DCF083P
PMX-C105G	DCF450K
PMX-C105G	DCF497P
PMX-C106T	DCF400P
PMX-C108Z	DCF332K
PMX-C10Z	DCF540P
PMX-C111L	DCF536P
PMX-C21T	DCF231K
PMY-006	DCF080K
PMY-006(E)	DCF080K

PURFLUX	DENSO
AH101	DCF018P
AH103	DCF096P
AH103	DCF517P

PURFLUX	DENSO
AH104	DCF042P
AH104	DCF461P
AH105	DCF031P
AH106	DCF541P
AH119	DCF508P
AH125	DCF287P
AH127	DCF109P
AH133	DCF416P
AH136	DCF268P
AH137	DCF514P
AH138	DCF009P
AH140	DCF493P
AH143	DCF502P
AH144	DCF270P
AH148	DCF302P
AH151	DCF361P
AH157	DCF550P
AH158	DCF537P
AH160	DCF357P
AH167	DCF474P
AH171	DCF482P
AH173	DCF494P
AH174	DCF086P
AH175	DCF227P
AH175	DCF526P
AH179	DCF470P
AH182	DCF446P
AH184	DCF463P
AH185	DCF492P
AH186	DCF418P
AH187	DCF016P
AH188	DCF345K
AH189	DCF383P
AH189	DCF469P
AH191	DCF462P
AH191	DCF576P
AH192	DCF061P
AH193	DCF540P
AH194	DCF153K
AH198	DCF481P
AH199	DCF413P
AH201	DCF504P
AH205	DCF532P
AH206	DCF510P
AH209	DCF477P
AH210	DCF353P
AH212	DCF471P
AH214	DCF255P
AH220-2	DCF512P
AH221	DCF561P
AH223	DCF562P
AH225	DCF190P
AH230	DCF410P
AH231	DCF536P
AH233	DCF499P
AH234	DCF414P
AH238	DCF465P
AH244	DCF488P
AH245-2	DCF560P
AH246	DCF096P
AH248	DCF486P
AH251-2	DCF563P
AH255	DCF383P
AH256	DCF382P
AH257	DCF366P
AH259	DCF382P
AH261-2	DCF479P
AH262	DCF467P
AH263	DCF454P
AH265	DCF485P
AH266	DCF473P
AH267	DCF566P
AH269	DCF571P

Cabin Air Filter

Cross Reference Chart - OE

PURFLUX	DENSO
AH271	DCF480P
AH273-2	DCF568P
AH280	DCF521P
AH284	DCF586P
AH286	DCF564P
AH291	DCF376P
AH297	DCF412P
AH298	DCF467P
AH300	DCF567P
AH301	DCF284P
AH303	DCF466P
AH306	DCF565P
AH3102	DCF570P
AH330	DCF572P
AH333	DCF353P
AH333	DCF354P
AH334	DCF408P
AH339	DCF573P
AH340	DCF509P
AH341	DCF574P
AH350	DCF377P
AH351	DCF423P
AH355-2	DCF303P
AH359	DCF582P
AH360	DCF263P
AH360	DCF577P
AH370	DCF583P
AH371	DCF580P
AH373	DCF581P
AH375-2	DCF266P
AH376	DCF589P
AH378	DCF449P
AH382	DCF295P
AH395	DCF471P
AH396	DCF584P
AH405	DCF579P
AH409	DCF587P
AH426	DCF578P
AH482	DCF588P
AH484	DCF386P
AH484	DCF590P
AH487	DCF374P
AH489-2	DCF187P
AH495	DCF585P
AH530	DCF388P
AH537	DCF577P
AHC102	DCF351K
AHC104	DCF002K
AHC104	DCF225K
AHC107	DCF044K
AHC119	DCF050K
AHC126	DCF035K
AHC128	DCF196K
AHC129	DCF094K
AHC138	DCF068K
AHC140	DCF460K
AHC147	DCF056K
AHC154	DCF090K
AHC166	DCF513P
AHC173	DCF072K
AHC173	DCF343K
AHC177	DCF048K
AHC178	DCF002K
AHC179	DCF071K
AHC181	DCF347K
AHC183	DCF346K
AHC184	DCF054K
AHC187	DCF062K
AHC190	DCF039K
AHC190	DCF450K
AHC190	DCF497P
AHC191	DCF458K
AHC192	DCF063K

PURFLUX	DENSO
AHC195	DCF105K
AHC198	DCF223K
AHC200	DCF125K
AHC203	DCF221K
AHC205	DCF072K
AHC209	DCF234K
AHC211	DCF252K
AHC212	DCF106K
AHC213	DCF211K
AHC215	DCF162K
AHC219	DCF419K
AHC237	DCF452P
AHC237	DCF453K
AHC238	DCF236K
AHC2392	DCF015K
AHC241-2	DCF163K
AHC246	DCF450K
AHC247-2	DCF122K
AHC256	DCF385K
AHC258	DCF332K
AHC261-2	DCF073K
AHC262	DCF344K
AHC268	DCF081K
AHC278	DCF181K
AHC282	DCF365K
AHC294	DCF161K
AHC299	DCF340K
AHC304	DCF352K
AHC342	DCF170K
AHC374	DCF300K
AHC378	DCF052K
AHC378	DCF053K
AHC379	DCF152K
AHC407-2	DCF160K
AHC418	DCF053K
AHC421	DCF067K
AHC484	DCF387K

SAKURA AUTOMOTIVE	DENSO
CA-1001	DCF302P
CA-1001	DCF303P
CA-1002	DCF305P
CA-10080	DCF306P
CA-10970	DCF423P
CA-10980	DCF309P
CA-1101	DCF353P
CA-1102	DCF353P
CA-1102	DCF354P
CA-1103	DCF353P
CA-1105	DCF383P
CA-1106	DCF469P
CA-11070	DCF361P
CA-1110	DCF383P
CA-1113	DCF353P
CA-1114	DCF382P
CA-11290	DCF562P
CA-11350	DCF585P
CA-11380	DCF386P
CA-1401	DCF375P
CA-1402	DCF466P
CA-14030	DCF460P
CA-14050	DCF377P
CA-14060	DCF227P
CA-14060	DCF526P
CA-14070	DCF330P
CA-14990	DCF380P
CA-1601	DCF512P
CA-1603	DCF255P
CA-1604	DCF109P
CA-1605	DCF466P
CA-1606	DCF561P
CA-16130	DCF573P
CA-16160	DCF473P

SAKURA AUTOMOTIVE	DENSO
CA-1704	DCF295P
CA-1705	DCF480P
CA-1707	DCF280P
CA-1708	DCF563P
CA-17090	DCF480P
CA-17100	DCF563P
CA-17160	DCF578P
CA-1804	DCF190P
CA-1807	DCF590P
CA-1808	DCF502P
CA-1810	DCF509P
CA-18120	DCF467P
CA-18170	DCF376P
CA-18200	DCF565P
CA-18230	DCF187P
CA-18240	DCF326P
CA-18250	DCF574P
CA-18330	DCF418P
CA-18360	DCF588P
CA-18970	DCF467P
CA-1902	DCF009P
CA-1903	DCF096P
CA-1905	DCF474P
CA-1910	DCF474P
CA-19160	DCF465P
CA-19190	DCF471P
CA-19240	DCF517P
CA-19260	DCF589P
CA-19960	DCF471P
CA-19970	DCF500P
CA-21010	DCF405P
CA-21030	DCF540P
CA-21040	DCF493P
CA-21080-S	DCF560P
CA-21970	DCF479P
CA-22040	DCF485P
CA-22050	DCF504P
CA-23020	DCF482P
CA-24980	DCF302P
CA-25020	DCF502P
CA-25070	DCF413P
CA-25090	DCF579P
CA-25950	DCF586P
CA-25960	DCF492P
CA-26040	DCF514P
CA-26050	DCF144P
CA-26160	DCF452P
CA-2801	DCF366P
CA-2802	DCF410P
CA-2805	DCF266P
CA-28051	DCF266P
CA-2807	DCF486P
CA-2808	DCF284P
CA-28130	DCF483P
CA-28140	DCF569P
CA-28150	DCF582P
CA-28160	DCF263P
CA-28160	DCF577P
CA-28170	DCF268P
CA-28190	DCF570P
CA-28200	DCF408P
CA-28260	DCF263P
CA-28260	DCF577P
CA-28390	DCF388P
CA-29010	DCF279P
CA-29020	DCF279P
CA-29030	DCF283P
CA-2911	DCF075P
CA-2912	DCF076P
CA-2990	DCF285P
CA-3001	DCF402P
CA-30020	DCF449P
CA-30050	DCF403P

SAKURA AUTOMOTIVE	DENSO
CA-30060	DCF475P
CA-30070	DCF016P
CA-30080	DCF064P
CA-30080	DCF475P
CA-30090	DCF096P
CA-30110	DCF567P
CA-30900	DCF061P
CA-30970	DCF581P
CA-3101	DCF463P
CA-3102	DCF461P
CA-3104	DCF508P
CA-31050	DCF446P
CA-31060	DCF477P
CA-31070	DCF571P
CA-31080	DCF522P
CA-31100	DCF583P
CA-31110	DCF575P
CA-31920	DCF268P
CA-31940	DCF576P
CA-31950	DCF400P
CA-32040	DCF193P
CA-32050	DCF541P
CA-32060	DCF488P
CA-32990	DCF510P
CA-3300	DCF357P
CA-37010	DCF566P
CA-37960	DCF411P
CA-37980	DCF516P
CA-37990	DCF286P
CA-49010	DCF462P
CA-53860	DCF412P
CA-53870	DCF587P
CA-53990	DCF159P
CA-6507	DCF031P
CA-6511	DCF374P
CA-6515	DCF476P
CA-6516	DCF486P
CA-65180	DCF371P
CA-65210	DCF564P
CA-65250	DCF245P
CA-8904	DCF242P
CAC-1002	DCF181K
CAC-1006	DCF300K
CAC-10070	DCF053K
CAC-10100	DCF336K
CAC-1103	DCF239K
CAC-1113	DCF239K
CAC-1113	DCF384K
CAC-1114	DCF385K
CAC-11380	DCF387K
CAC-1703	DCF457K
CAC-1705	DCF120K
CAC-1801	DCF273K
CAC-1801	DCF389K
CAC-18120	DCF344K
CAC-19160	DCF236K
CAC-19180	DCF105K
CAC-19190	DCF106K
CAC-19230	DCF365K
CAC-19970	DCF094K
CAC-21010	DCF346K
CAC-21050	DCF211K
CAC-21060	DCF071K
CAC-21970	DCF073K
CAC-22020	DCF048K
CAC-23020	DCF198K
CAC-24070	DCF072K
CAC-24070	DCF343K
CAC-24080	DCF352K
CAC-26050	DCF252K
CAC-26070	DCF168K
CAC-26080	DCF081K
CAC-26100	DCF170K

Cabin Air Filter

Cross Reference Chart - OE

SAKURA AUTOMOTIVE	DENSO
CAC-26120-S	DCF163K
CAC-26130	DCF152K
CAC-26160	DCF453K
CAC-3001	DCF015K
CAC-30020	DCF052K
CAC-30021	DCF053K
CAC-30050	DCF419K
CAC-30060	DCF340K
CAC-30070	DCF062K
CAC-30080	DCF065K
CAC-30090	DCF450K
CAC-30100	DCF420K
CAC-30900	DCF063K
CAC-3101	DCF054K
CAC-3102	DCF225K
CAC-3103	DCF002K
CAC-3104	DCF050K
CAC-31060	DCF234K
CAC-31080	DCF122K
CAC-31990	DCF059K
CAC-32060	DCF201K
CAC-32990	DCF199K
CAC-37980	DCF127K
CAC-49011	DCF458K
CAC-49020	DCF351K
CAC-53860	DCF341K
CAC-53890	DCF035K
CAC-6515	DCF200K
CAC-6516	DCF223K
CAC-66010	DCF080K

SIVENTO	DENSO
G106	DCF044K
G111	DCF090K
G227	DCF002K
G340	DCF059K
G417	DCF072K
G417	DCF343K
G437	DCF386P
G437	DCF387K
G505	DCF239K
G507	DCF345K
G612	DCF072K
G612	DCF343K
G626	DCF341K
G630	DCF053K
G634	DCF090K
G661	DCF067K
G681	DCF347K
G689	DCF239K
G708	DCF420K
G720	DCF201K
G729	DCF163K
G730	DCF168K
G731	DCF170K
G733	DCF382P
G744	DCF080K
G757	DCF119K
G762	DCF300K
P104	DCF446P
P105	DCF536P
P106	DCF507P
P110	DCF083P
P200	DCF402P
P204	DCF031P
P205	DCF541P
P208	DCF461P
P211	DCF096P
P211	DCF517P
P212	DCF268P
P214	DCF508P
P215	DCF009P
P216	DCF514P

SIVENTO	DENSO
P220	DCF500P
P221	DCF476P
P224	DCF482P
P225	DCF550P
P226	DCF474P
P228	DCF463P
P229	DCF016P
P230	DCF537P
P240	DCF141P
P312	DCF569P
P313	DCF572P
P314	DCF330P
P317	DCF565P
P319	DCF574P
P324	DCF471P
P325	DCF576P
P326	DCF589P
P329	DCF380P
P330	DCF580P
P337	DCF581P
P339	DCF587P
P343	DCF583P
P344	DCF578P
P347	DCF584P
P348	DCF579P
P360	DCF585P
P362	DCF590P
P363	DCF588P
P387	DCF582P
P405	DCF502P
P406	DCF018P
P409	DCF416P
P410	DCF270P
P415	DCF493P
P418	DCF513P
P432	DCF361P
P433	DCF361P
P437	DCF386P
P502	DCF075P
P503	DCF076P
P505	DCF357P
P506	DCF353P
P506	DCF354P
P602	DCF286P
P604	DCF190P
P608	DCF486P
P609	DCF227P
P609	DCF526P
P613	DCF462P
P614	DCF475P
P626	DCF412P
P627	DCF255P
P629	DCF517P
P631	DCF411P
P632	DCF492P
P634	DCF504P
P636	DCF512P
P637	DCF466P
P639	DCF540P
P640	DCF410P
P641	DCF144P
P646	DCF210P
P646	DCF408P
P647	DCF366P
P651	DCF266P
P655	DCF480P
P657	DCF532P
P658	DCF242P
P660	DCF061P
P662	DCF446P
P664	DCF486P
P665	DCF510P
P669	DCF413P

SIVENTO	DENSO
P672	DCF243P
P676	DCF280P
P677	DCF279P
P678	DCF283P
P680	DCF374P
P682	DCF561P
P683	DCF449P
P685	DCF499P
P686	DCF405P
P688	DCF403P
P689	DCF353P
P691	DCF064P
P691	DCF475P
P692	DCF268P
P693	DCF486P
P694	DCF471P
P695	DCF465P
P699	DCF284P
P701	DCF096P
P703	DCF305P
P704	DCF452P
P707	DCF522P
P713	DCF303P
P714	DCF279P
P717	DCF562P
P719	DCF563P
P720	DCF488P
P721	DCF377P
P722	DCF466P
P723	DCF582P
P725	DCF473P
P733	DCF382P
P734	DCF560P
P735	DCF467P
P736	DCF263P
P738	DCF353P
P741	DCF230P
P741	DCF375P
P742	DCF566P
P745	DCF454P
P746	DCF245P
P750	DCF509P
P751	DCF187P
P753	DCF423P
P754	DCF285P
P756	DCF483P
P759	DCF466P
P761	DCF371P
P763	DCF467P
P765	DCF567P
P773	DCF284P
P774	DCF467P
P775	DCF479P
P776	DCF582P
P780	DCF460P
P782	DCF306P
P784	DCF485P
P786	DCF568P
P789	DCF570P
P794	DCF573P
P797	DCF376P
P798	DCF564P
P913	DCF507P
P922	DCF521P
P923	DCF418P

SOFIMA	DENSO
S 3147 C	DCF382P
S 3184 C	DCF383P
S 4266 CA	DCF385K
S3120C	DCF563P
S3123C	DCF561P
S3132C	DCF562P

SOFIMA	DENSO
S3143C	DCF560P
S3149C	DCF569P
S3153C	DCF571P
S3156C	DCF567P
S3160C	DCF573P
S3163C	DCF570P
S3164C	DCF568P
S3190C	DCF576P
S3191C	DCF582P
S3206C	DCF566P
S3208C	DCF577P
S3209C	DCF572P
S3210C	DCF580P
S3211C	DCF584P
S3215C	DCF574P
S3223C	DCF565P
S3224C	DCF581P
S3233C	DCF583P
S3254C	DCF564P
S3256C	DCF579P
S3276C	DCF586P
S3320C	DCF587P
S3321C	DCF579P
S3330C	DCF578P

SWAG	DENSO
81 92 7465	DCF382P
81 93 0242	DCF382P

TOPRAN	DENSO
600 038	DCF382P
600 044	DCF385K

UFI	DENSO
53.001.00	DCF031P
53.004.00	DCF268P
53.005.00	DCF514P
53.006.00	DCF461P
53.007.00	DCF009P
53.013.00	DCF508P
53.015.00	DCF541P
53.016.00	DCF096P
53.017.00	DCF500P
53.021.00	DCF018P
53.023.00	DCF507P
53.030.00	DCF482P
53.031.00	DCF462P
53.032.00	DCF463P
53.033.00	DCF083P
53.034.00	DCF474P
53.039.00	DCF540P
53.040.00	DCF513P
53.042.00	DCF536P
53.043.00	DCF504P
53.044.00	DCF493P
53.045.00	DCF486P
53.047.00	DCF476P
53.049.00	DCF287P
53.050.00	DCF357P
53.052.00	DCF190P
53.059.00	DCF537P
53.060.00	DCF502P
53.065.00	DCF255P
53.067.00	DCF446P
53.068.00	DCF550P
53.069.00	DCF532P
53.075.00	DCF227P
53.075.00	DCF526P
53.077.00	DCF410P
53.084.00	DCF270P
53.086.00	DCF492P
53.088.00	DCF499P
53.090.00	DCF405P

Cabin Air Filter

Cross Reference Chart - OE

UFI	DENSO
53.093.00	DCF480P
53.095.00	DCF144P
53.098.00	DCF510P
53.100.00	DCF412P
53.101.00	DCF061P
53.102.00	DCF471P
53.103.00	DCF353P
53.105.00	DCF411P
53.107.00	DCF413P
53.108.00	DCF512P
53.109.00	DCF466P
53.110.00	DCF521P
53.112.00	DCF486P
53.116.00	DCF284P
53.118.00	DCF366P
53.119.00	DCF266P
53.120.00	DCF563P
53.121.00	DCF268P
53.123.00	DCF561P
53.124.00	DCF488P
53.125.00	DCF469P
53.126.00	DCF243P
53.128.00	DCF309P
53.129.00	DCF465P
53.130.00	DCF454P
53.131.00	DCF418P
53.132.00	DCF562P
53.134.00	DCF076P
53.135.00	DCF330P
53.138.00	DCF075P
53.141.00	DCF242P
53.143.00	DCF560P
53.146.00	DCF509P
53.147.00	DCF382P
53.148.00	DCF449P
53.149.00	DCF569P
53.151.00	DCF371P
53.152.00	DCF483P
53.153.00	DCF571P
53.156.00	DCF567P
53.157.00	DCF485P
53.158.00	DCF016P
53.159.00	DCF473P
53.160.00	DCF573P
53.162.00	DCF517P
53.163.00	DCF570P
53.164.00	DCF568P
53.183.00	DCF460P
53.184.00	DCF383P
53.186.00	DCF376P
53.189.00	DCF477P
53.190.00	DCF576P
53.191.00	DCF582P
53.197.00	DCF361P
53.201.00	DCF374P
53.206.00	DCF566P
53.208.00	DCF263P
53.208.00	DCF577P
53.209.00	DCF572P
53.210.00	DCF580P
53.211.00	DCF584P
53.213.00	DCF230P
53.213.00	DCF375P
53.215.00	DCF574P
53.222.00	DCF377P
53.223.00	DCF565P
53.224.00	DCF581P
53.226.00	DCF522P
53.228.00	DCF403P
53.231.00	DCF516P
53.232.00	DCF109P
53.233.00	DCF583P
53.245.00	DCF145P

UFI	DENSO
53.247.00	DCF452P
53.248.00	DCF353P
53.248.00	DCF354P
53.249.00	DCF590P
53.252.00	DCF042P
53.254.00	DCF564P
53.256.00	DCF579P
53.258.00	DCF187P
53.260.00	DCF467P
53.274.00	DCF423P
53.276.00	DCF586P
53.292.00	DCF502P
53.320.00	DCF587P
53.321.00	DCF579P
53.330.00	DCF578P
5321800	DCF467P
5323400	DCF402P
5323600	DCF096P
54.100.00	DCF223K
54.101.00	DCF054K
54.102.00	DCF035K
54.103.00	DCF450K
54.107.00	DCF044K
54.109.00	DCF002K
54.111.00	DCF071K
54.113.00	DCF345K
54.114.00	DCF458K
54.115.00	DCF105K
54.118.00	DCF094K
54.124.00	DCF052K
54.125.00	DCF346K
54.126.00	DCF072K
54.126.00	DCF343K
54.127.00	DCF419K
54.128.00	DCF340K
54.130.00	DCF161K
54.131.00	DCF152K
54.132.00	DCF162K
54.133.00	DCF252K
54.134.00	DCF199K
54.136.00	DCF106K
54.137.00	DCF063K
54.140.00	DCF118K
54.142.00	DCF211K
54.143.00	DCF200K
54.144.00	DCF181K
54.145.00	DCF172K
54.146.00	DCF453K
54.147.00	DCF053K
54.148.00	DCF234K
54.149.00	DCF170K
54.151.00	DCF347K
54.154.00	DCF450K
54.155.00	DCF127K
54.156.00	DCF072K
54.158.00	DCF236K
54.160.00	DCF332K
54.161.00	DCF081K
54.162.00	DCF201K
54.165.00	DCF056K
54.167.00	DCF344K
54.170.00	DCF365K
54.172.00	DCF073K
54.174.00	DCF221K
54.194.00	DCF460K
54.195.00	DCF050K
54.199.00	DCF576P
54.215.00	DCF163K
54.220.00	DCF300K
54.230.00	DCF198K
54.240.00	DCF065K
54.246.00	DCF153K
54.247.00	DCF341K

UFI	DENSO
54.262.00	DCF090K
54.263.00	DCF002K
54.263.00	DCF225K
54.266.00	DCF385K
54.270.00	DCF068K
54.275.00	DCF120K

UNIPART	DENSO
UGCGFE2901	DCF508P
UGCGFE2902	DCF096P
UGCGFE2904	DCF031P
UGCGFE2907	DCF002K
UGCGFE2907	DCF225K
UGCGFE2907	DCF461P
UGCGFE2912	DCF094K
UGCGFE2912	DCF500P
UGCGFE2922	DCF109P
UGCGFE2924	DCF493P
UGCGFE2940	DCF018P
UGCGFE2943	DCF068K
UGCGFE2947	DCF476P
UGCGFE2951	DCF474P
UGCGFE2955	DCF517P
UGCGFE2963	DCF502P
UGCGFE2966	DCF048K
UGCGFE2967	DCF513P
UGCGFE2972	DCF090K
UGCGFE2972	DCF504P
UGCGFE2976	DCF227P
UGCGFE2976	DCF526P
UGCGFE2978	DCF458K
UGCGFE2979	DCF462P
UGCGFE2982	DCF357P
UGCGFE2984	DCF492P
UGCGFE2996	DCF413P
UGCGFE2999	DCF532P
UGCGFE3003	DCF002K
UGCGFE3004	DCF083P
UGCGFE3004	DCF450K
UGCGFE3004	DCF497P
UGCGFE3007	DCF463P
UGCGFE3009	DCF015K
UGCGFE3009	DCF402P
UGCGFE3013	DCF016P
UGCGFE3013	DCF062K
UGCGFE3015	DCF416P
UGCGFE3016	DCF482P
UGCGFE3017	DCF486P
UGCGFE3019	DCF517P
UGCGFE3024	DCF512P
UGCGFE3025	DCF471P
UGCGFE3026	DCF105K
UGCGFE3027	DCF105K
UGCGFE3028	DCF071K
UGCGFE3036	DCF446P
UGCGFE3047	DCF061P
UGCGFE3056	DCF469P
UGCGFE3060	DCF353P
UGCGFE3062	DCF234K
UGCGFE3062	DCF477P
UGCGFE3065	DCF072K
UGCGFE3065	DCF343K
UGCGFE3065	DCF352K
UGCGFE3087	DCF418P
UGCGFE3088	DCF052K
UGCGFE3088	DCF449P
UGCGFE3089	DCF052K
UGCGFE3090	DCF467P
UGCGFE3091	DCF510P
UGCGFE3092	DCF499P
UGCGFE3109	DCF223K
UGCGFE3111	DCF211K
UGCGFE3117	DCF255P

UNIPART	DENSO
UGCGFE3117	DCF473P
UGCGFE3117	DCF561P
UGCGFE3119	DCF411P
UGCGFE3120	DCF236K
UGCGFE3120	DCF465P
UGCGFE3121	DCF452P
UGCGFE3121	DCF453K
UGCGFE3122	DCF562P
UGCGFE3244	DCF560P
UGCGFE3245	DCF563P
UGCGFE3246	DCF201K
UGCGFE3246	DCF488P
UGCGFE3248	DCF450K
UGCGFE3250	DCF122K
UGCGFE3252	DCF403P
UGCGFE3252	DCF419K
UGCGFE3254	DCF466P
UGCGFE3256	DCF382P
UGCGFE3261	DCF096P
UGCGFE3263	DCF242P
UGCGFE3279	DCF509P
UGCGFE3281	DCF284P
UGCGFE3282	DCF266P
UGCGFE3287	DCF564P
UGCGFE3288	DCF566P
UGCGFE3290	DCF081K
UGCGFE3294	DCF467P
UGCGFE3296	DCF161K
UGCGFE3301	DCF106K
UGCGFE3315	DCF181K
UGCGFE3318	DCF480P
UGCGFE3330	DCF568P
UGCGFE3332	DCF127K
UGCGFE3332	DCF516P
UGCGFE3337	DCF073K
UGCGFE3337	DCF479P
UGCGFE3349	DCF454P
UGCGFE3350	DCF466P
UGCGFE3350	DCF573P
UGCGFE3361	DCF460P
UGCGFE3365	DCF475P
UGCGFE3381	DCF567P
UGCGFE3385	DCF521P
UGCGFE3392	DCF144P
UGCGFE3392	DCF252K
UGCGFE4242	DCF460P

VALEO	DENSO
560110	DCF382P
661027S	DCF346K
698146	DCF018P
698159/885	DCF461P
698163	DCF287P
698164	DCF508P
698165	DCF541P
698166	DCF031P
698169	DCF009P
698169	DCF514P
698177	DCF416P
698196	DCF109P
698197	DCF507P
698246	DCF015K
698247	DCF500P
698255	DCF502P
698279	DCF270P
698454	DCF083P
698475	DCF495P
698487	DCF474P
698488	DCF493P
698489	DCF016P
698535	DCF090K
698540	DCF405P
698594	DCF492P

Cabin Air Filter

Cross Reference Chart - OE

VALEO	DENSO
698606	DCF463P
698662	DCF476P
698663	DCF482P
698664	DCF470P
698680	DCF513P
698681	DCF357P
698682	DCF056K
698683	DCF054K
698685	DCF462P
698686	DCF225K
698687	DCF044K
698689	DCF042P
698691	DCF086P
698692	DCF039K
698692	DCF497P
698693	DCF105K
698694	DCF478P
698694	DCF480P
698696	DCF094K
698697	DCF068K
698702	DCF144P
698703	DCF164K
698704	DCF141P
698704	DCF142P
698704	DCF145P
698707	DCF190P
698708	DCF198K
698709	DCF200K
698711	DCF223K
698711	DCF481P
698712	DCF550P
698713	DCF347K
698714	DCF071K
698719	DCF540P
698724	DCF061P
698725	DCF063K
698730	DCF413P
698735	DCF512P
698737	DCF221K
698738	DCF532P
698739	DCF458K
698740	DCF162K
698741	DCF252K
698742	DCF153K
698742	DCF161K
698743	DCF152K
698744	DCF035K
698746	DCF196K
698747	DCF048K
698749	DCF460K
698750	DCF062K
698751	DCF125K
698768	DCF234K
698771	DCF494P
698773	DCF227P
698773	DCF526P
698774	DCF345K
698775	DCF475P
698776	DCF340K
698777	DCF412P
698778	DCF341K
698779	DCF517P
698790	DCF400P
698792	DCF059K
698793	DCF231K
698794	DCF446P
698795	DCF469P
698796	DCF353P
698800	DCF449P
698801	DCF052K
698802	DCF181K
698817	DCF411P
698838	DCF262P

VALEO	DENSO
698840	DCF537P
698856	DCF064P
698857	DCF065K
698858	DCF536P
698859	DCF076P
698860	DCF075P
698862	DCF420K
698863	DCF403P
698864	DCF419K
698865	DCF067K
698866	DCF499P
698867	DCF504P
698868	DCF561P
698870	DCF480P
698871	DCF521P
698872	DCF172K
698873	DCF188K
698876	DCF510P
698877	DCF199K
698882	DCF471P
698883	DCF106K
698884	DCF211K
698886	DCF466P
698887	DCF280P
698888	DCF410P
698890	DCF457K
698892	DCF563P
698894	DCF374P
701021	DCF382P
701021	DCF385K
708163	DCF268P
708716/686	DCF002K
708730	DCF413P
708736	DCF414P
708748	DCF351K
708749	DCF460K
715500	DCF522P
715502	DCF096P
715503	DCF092K
715503	DCF450K
715505	DCF118K
715506	DCF452P
715507	DCF453K
715508	DCF170K
715509	DCF053K
715510	DCF465P
715512	DCF072K
715512	DCF343K
715513	DCF418P
715515	DCF562P
715516	DCF408P
715517	DCF366P
715518	DCF516P
715519	DCF127K
715521	DCF486P
715522	DCF279P
715523	DCF283P
715524	DCF284P
715525	DCF266P
715526	DCF243P
715528	DCF306P
715532	DCF506P
715533	DCF448K
715535	DCF242P
715537	DCF120K
715540	DCF473P
715542	DCF353P
715542	DCF354P
715543	DCF303P
715544	DCF163K
715545	DCF423P
715546	DCF300K
715547	DCF309P

VALEO	DENSO
715548	DCF303P
715550	DCF382P
7155501	DCF122K
715552	DCF488P
715553	DCF201K
715554	DCF479P
715555	DCF073K
715556	DCF560P
715559	DCF509P
715560	DCF273K
715561	DCF187P
715563	DCF326P
715564	DCF375P
715570	DCF352K
715572	DCF361P
715573	DCF255P
715578	DCF050K
715579	DCF571P
715581	DCF477P
715585	DCF567P
715588	DCF245P
715592	DCF263P
715592	DCF577P
715597	DCF566P
715598	DCF286P
715599	DCF295P
715602	DCF081K
715603	DCF305P
715609	DCF377P
715611	DCF069K
715614	DCF332K
715616	DCF485P
715618	DCF285P
715619	DCF239K
715619	DCF384K
715620	DCF382P
715620	DCF385K
715621	DCF160K
715622	DCF336K
715623	DCF344K
715628	DCF236K
715631	DCF467P
715636	DCF454P
715638	DCF483P
715640	DCF119K
715643	DCF168K
715644	DCF460P
715645	DCF193P
715648	DCF080K
715649	DCF568P
715651	DCF467P
715654	DCF371P
715661	DCF365K
715662	DCF570P
715665	DCF053K
715684	DCF159P
715685	DCF402P
715688	DCF302P
715689	DCF383P
715692	DCF573P
715694	DCF376P
715698	DCF330P
715706	DCF574P
715721	DCF565P
715730	DCF385K
715737	DCF576P
715740	DCF582P
715741	DCF569P
715742	DCF589P
715743	DCF380P
715744	DCF583P
715746	DCF579P
715751	DCF587P

VALEO	DENSO
715755	DCF580P
715806	DCF575P
715809	DCF584P
715813	DCF578P
715815	DCF581P
715816	DCF577P
716026	DCF172K
716031	DCF044K
716042	DCF446P
716043	DCF477P

VEMO	DENSO
V10-30-0003	DCF575P
V10-30-1002	DCF234K
V10-30-1002	DCF477P
V10-30-1003-1	DCF449P
V10-30-1004	DCF571P
V10-30-1010-1	DCF508P
V10-30-1013	DCF461P
V10-30-1014	DCF463P
V10-30-1016	DCF268P
V10-30-1017	DCF287P
V10-30-1031	DCF400P
V10-30-1049-1	DCF446P
V10-30-2525-1	DCF094K
V10-30-2525-1	DCF500P
V10-30-2526-1	DCF462P
V10-30-2527	DCF522P
V10-30-2529	DCF576P
V10-30-2529-1	DCF576P
V10-30-2530	DCF583P
V10-30-5001	DCF400P
V10-30-5002	DCF522P
V10-31-1001-1	DCF052K
V10-31-1010	DCF050K
V10-31-1025-1	DCF056K
V10-31-1032-1	DCF059K
V10-31-1033	DCF234K
V10-31-1040-1	DCF002K
V10-31-1040-1	DCF225K
V10-31-1041-1	DCF054K
V10-31-1042-1	DCF094K
V10-31-1042-1	DCF500P
V10-31-1043	DCF458K
V10-31-2527-1	DCF122K
V10-31-2529	DCF576P
V10-31-5002	DCF122K
V20-30-1006-1	DCF064P
V20-30-1006-1	DCF475P
V20-30-1007	DCF420K
V20-30-1008-1	DCF061P
V20-30-1009-1	DCF403P
V20-30-1010	DCF096P
V20-30-1012	DCF567P
V20-30-1035	DCF262P
V20-30-1040-1	DCF402P
V20-30-1045-1	DCF016P
V20-30-1046-1	DCF475P
V20-30-1048	DCF581P
V20-30-5003	DCF403P
V20-30-5007	DCF262P
V20-30-5008	DCF402P
V20-31-1006-1	DCF065K
V20-31-1007-1	DCF420K
V20-31-1008-1	DCF063K
V20-31-1009-1	DCF419K
V20-31-1010	DCF450K
V20-31-1038-1	DCF015K
V20-31-1038-1	DCF402P
V20-31-1039-1	DCF340K
V20-31-1043-1	DCF062K
V20-31-1044	DCF015K
V20-31-1044	DCF402P

Cabin Air Filter

Cross Reference Chart - OE

VEMO	DENSO
V20-31-1051	DCF065K
V20-31-5001	DCF065K
V20-31-5002	DCF419K
V20-31-5006	DCF015K
V20-31-5006	DCF402P
V22-30-1001	DCF536P
V22-30-1002	DCF513P
V22-30-1003	DCF540P
V22-30-1005	DCF532P
V22-30-1008	DCF454P
V22-30-1009	DCF562P
V22-30-1010	DCF479P
V22-30-1013	DCF485P
V22-30-2020	DCF018P
V22-30-5001	DCF479P
V22-31-1002	DCF536P
V22-31-1003	DCF071K
V22-31-1005	DCF072K
V22-31-1006	DCF332K
V22-31-1007	DCF346K
V22-31-1008	DCF513P
V22-31-1010	DCF073K
V22-31-1012	DCF562P
V22-31-1013	DCF454P
V22-31-1015	DCF073K
V22-31-5001	DCF073K
V24-30-1003	DCF048K
V24-30-1006	DCF448K
V24-30-1006	DCF506P
V24-30-1101	DCF042P
V24-30-1101	DCF044K
V24-30-1101	DCF507P
V24-30-1106	DCF090K
V24-30-1106	DCF504P
V24-30-1107	DCF499P
V24-30-1110	DCF083P
V24-30-1110	DCF450K
V24-30-1110	DCF497P
V24-30-1115	DCF580P
V24-30-1116	DCF584P
V24-30-5001	DCF048K
V24-31-1001	DCF048K
V24-31-1003	DCF083P
V24-31-1003	DCF450K
V24-31-1003	DCF497P
V24-31-1005	DCF090K
V24-31-1006	DCF448K
V24-31-1101	DCF044K
V24-31-1101	DCF507P
V24-31-1107	DCF499P
V24-31-5001	DCF048K
V25-30-1002	DCF474P
V25-30-1003-1	DCF471P
V25-30-1071	DCF096P
V25-30-1075-1	DCF517P
V25-30-1076	DCF465P
V25-30-1080	DCF589P
V25-31-1001-1	DCF105K
V25-31-1075-1	DCF106K
V25-31-1076	DCF236K
V25-31-1077	DCF365K
V26-30-1001	DCF109P
V26-30-1004	DCF512P
V26-30-1005	DCF466P
V26-30-1006	DCF255P
V26-30-1008	DCF561P
V26-30-1009	DCF473P
V26-30-1011	DCF573P
V26-30-5001	DCF512P
V30-30-1001-1	DCF159P
V30-30-1002-1	DCF141P
V30-30-1004	DCF345K
V30-30-1004-1	DCF345K

VEMO	DENSO
V30-30-1005	DCF142P
V30-30-1006-1	DCF009P
V30-30-1007	DCF514P
V30-30-1008	DCF144P
V30-30-1009	DCF145P
V30-30-1025	DCF537P
V30-30-1036	DCF341K
V30-30-1036	DCF412P
V30-30-1042-1	DCF521P
V30-30-1046	DCF452P
V30-30-5001	DCF159P
V30-30-5002	DCF514P
V30-31-1001-1	DCF537P
V30-31-1002-1	DCF162K
V30-31-1003-1	DCF164K
V30-31-1005	DCF153K
V30-31-1008	DCF144P
V30-31-1008	DCF252K
V30-31-1012	DCF160K
V30-31-1016	DCF152K
V30-31-1023-1	DCF068K
V30-31-1025-1	DCF341K
V30-31-1026	DCF035K
V30-31-1040	DCF345K
V30-31-1043	DCF161K
V30-31-1045-1	DCF170K
V30-31-1046	DCF172K
V30-31-1047	DCF181K
V30-31-1047	DCF305P
V30-31-1048	DCF453K
V30-31-1049	DCF163K
V30-31-1050	DCF168K
V30-31-1053	DCF081K
V30-31-1058	DCF587P
V30-31-5001	DCF162K
V30-31-5002	DCF514P
V30-31-5004	DCF160K
V30-31-5005	DCF161K
V30-31-5007	DCF163K
V30-31-5008	DCF168K
V32-30-0001	DCF480P
V32-30-0003	DCF563P
V32-30-0008	DCF480P
V32-31-0012	DCF457K
V32-31-5001	DCF457K
V33-31-0001	DCF067K
V33-31-0002	DCF080K
V37-30-0001	DCF303P
V37-30-0003	DCF309P
V37-30-0004	DCF467P
V37-30-0006	DCF344K
V37-31-0001	DCF300K
V37-31-0002	DCF053K
V37-31-0006	DCF344K
V38-30-1001	DCF368P
V38-30-1004	DCF190P
V38-30-1008	DCF509P
V38-30-1009	DCF376P
V38-30-1015	DCF588P
V38-31-0002	DCF273K
V38-31-0003	DCF509P
V38-31-0004	DCF574P
V40-30-1002	DCF486P
V40-30-1004	DCF201K
V40-30-1004	DCF488P
V40-30-1005	DCF371P
V40-30-1006	DCF564P
V40-30-1100	DCF541P
V40-30-1101-1	DCF031P
V40-30-1104-1	DCF476P
V40-30-1106	DCF482P
V40-30-1109	DCF550P
V40-30-1110	DCF510P

VEMO	DENSO
V40-30-1112	DCF460P
V40-30-5001	DCF550P
V40-31-1004	DCF201K
V40-31-1005	DCF564P
V40-31-1111-1	DCF196K
V40-31-1112	DCF223K
V40-31-1113-1	DCF199K
V40-31-1117-1	DCF198K
V40-31-1118-1	DCF200K
V40-31-1121	DCF371P
V42-30-1205-1	DCF493P
V42-30-1206	DCF560P
V42-30-1212	DCF479P
V42-30-5002	DCF479P
V42-31-1003	DCF347K
V42-31-1004	DCF460K
V42-31-1005	DCF211K
V45-31-1116	DCF351K
V46-30-1001	DCF502P
V46-30-1002	DCF270P
V46-30-1003	DCF416P
V46-30-1007	DCF502P
V46-30-1008	DCF413P
V46-30-1009	DCF492P
V46-30-1011	DCF568P
V46-30-1066	DCF418P
V46-30-1070	DCF565P
V46-30-1075	DCF586P
V46-30-5001	DCF568P
V46-31-1002	DCF502P
V46-31-1008	DCF221K
V46-31-1075	DCF418P
V48-30-0001	DCF411P
V48-30-0002	DCF516P
V48-30-0003	DCF286P
V48-31-0001	DCF127K
V51-30-0001	DCF075P
V51-30-0002	DCF242P
V51-30-0003	DCF243P
V51-30-0005	DCF076P
V51-30-0006	DCF245P
V52-30-0001	DCF266P
V52-30-0002	DCF366P
V52-30-0003	DCF410P
V52-30-0005	DCF486P
V52-30-0008	DCF263P
V52-30-0008	DCF577P
V52-30-0009	DCF210P
V52-30-0009	DCF408P
V52-30-0010	DCF570P
V52-30-0011	DCF577P
V52-30-5001	DCF266P
V52-30-5002	DCF570P
V53-30-0001	DCF284P
V53-30-0002	DCF279P
V53-30-0004	DCF283P
V53-30-0005	DCF483P
V53-30-0008	DCF280P
V53-30-0009	DCF569P
V53-30-5001	DCF279P
V53-30-5002	DCF283P
V53-31-0005	DCF483P
V63-30-0001	DCF590P
V63-30-0004	DCF326P
V64-30-0001	DCF377P
V64-30-0003	DCF374P
V64-30-0004	DCF330P
V64-30-0005	DCF230P
V64-30-0005	DCF375P
V70-30-0001	DCF357P
V70-30-0002-1	DCF353P
V70-30-0003	DCF469P
V70-30-0005	DCF361P

VEMO	DENSO
V70-30-0007	DCF353P
V70-30-0007	DCF354P
V70-30-0009	DCF382P
V70-30-0011	DCF383P
V70-31-0002	DCF239K
V70-31-0002	DCF353P
V70-31-0002	DCF384K
V70-31-0011	DCF383P
V70-31-1013	DCF382P
V70-31-1013	DCF385K
V95-30-1217	DCF566P
V95-31-1213	DCF072K
V95-31-1213	DCF343K
V95-31-1215	DCF352K

WILMINK GROUP	DENSO
WG1014684	DCF382P
WG1018806	DCF384K
WG1019083	DCF382P
WG1019088	DCF383P
WG1171651	DCF382P
WG1171651	DCF385K
WG1215356	DCF383P
WG1215570	DCF384K
WG1215682	DCF385K
WG1226899	DCF383P
WG1233547	DCF382P
WG1233548	DCF382P
WG1234064	DCF383P
WG1234065	DCF383P
WG1368668	DCF382P
WG1368668	DCF385K
WG1371780	DCF385K
WG1431967	DCF382P
WG1431995	DCF382P
WG1724300	DCF389K
WG1735470	DCF384K
WG1735533	DCF383P
WG1735534	DCF382P
WG1735534	DCF385K
WG1735537	DCF384K
WG1735599	DCF389K
WG1746919	DCF383P
WG1747028	DCF383P
WG1747164	DCF387K
WG1747225	DCF382P
WG1747225	DCF385K
WG1747372	DCF389K
WG1750634	DCF386P
WG1750635	DCF387K
WG1787510	DCF385K
WG1793572	DCF382P
WG1793572	DCF385K
WG1793711	DCF384K
WG1793712	DCF382P
WG1793712	DCF385K
WG1793775	DCF383P
WG1793816	DCF385K

WIX FILTERS	DENSO
WP2002	DCF570P
WP2010	DCF565P
WP2012	DCF569P
WP2018	DCF572P
WP2026	DCF574P
WP2030	DCF371P
WP2038	DCF573P
WP2046	DCF263P
WP2046	DCF577P
WP2059	DCF336K
WP2064	DCF582P
WP2070	DCF383P
WP2080	DCF581P

Cabin Air Filter

Cross Reference Chart - OE

WIX FILTERS	DENSO
WP2086	DCF576P
WP2088	DCF575P
WP2090	DCF580P
WP2092	DCF583P
WP2096	DCF471P
WP2108	DCF578P
WP2110	DCF579P
WP2114	DCF584P
WP2124	DCF588P
WP2132	DCF585P
WP2134	DCF587P
WP2138	DCF586P
WP2144	DCF590P
WP2146	DCF589P
WP2158	DCF386P
WP2159	DCF387K
WP2160	DCF388P
WP6800	DCF541P
WP6802	DCF193P
WP6803	DCF196K
WP6804	DCF031P
WP6808	DCF508P
WP6809	DCF050K
WP6809	DCF508P
WP6812	DCF461P
WP6813	DCF002K
WP6816	DCF517P
WP6822	DCF075P
WP6826	DCF076P
WP6828	DCF476P
WP6829	DCF200K
WP6834	DCF109P
WP6841	DCF351K
WP6848	DCF500P
WP6849	DCF094K
WP6849	DCF500P
WP6865	DCF056K
WP6870	DCF042P
WP6870	DCF507P
WP6871	DCF507P
WP6876	DCF086P
WP6888	DCF550P
WP6895	DCF002K
WP6912	DCF536P
WP6914	DCF495P
WP6918	DCF482P
WP6922	DCF502P
WP6926	DCF493P
WP6927	DCF460K
WP6928	DCF502P
WP6932	DCF270P
WP6934	DCF514P
WP6936	DCF474P
WP6942	DCF400P
WP6955	DCF015K
WP6955	DCF402P
WP6966	DCF416P
WP6976	DCF403P
WP6977	DCF419K
WP6980	DCF190P
WP6984	DCF537P
WP6998	DCF463P
WP6999	DCF054K
WP9001	DCF090K
WP9002	DCF016P
WP9003	DCF062K
WP9009	DCF345K
WP9024	DCF227P
WP9024	DCF526P
WP9026	DCF239K
WP9027	DCF239K
WP9027	DCF384K
WP9034	DCF481P

WIX FILTERS	DENSO
WP9035	DCF223K
WP9036	DCF462P
WP9092	DCF042P
WP9100	DCF494P
WP9101	DCF072K
WP9106	DCF492P
WP9110	DCF478P
WP9111	DCF105K
WP9112	DCF470P
WP9113	DCF071K
WP9114	DCF513P
WP9116	DCF039K
WP9116	DCF497P
WP9117	DCF039K
WP9125	DCF048K
WP9130	DCF504P
WP9136	DCF469P
WP9140	DCF061P
WP9141	DCF063K
WP9142	DCF540P
WP9147	DCF052K
WP9160	DCF286P
WP9162	DCF517P
WP9164	DCF471P
WP9165	DCF106K
WP9166	DCF477P
WP9167	DCF234K
WP9168	DCF064P
WP9169	DCF065K
WP9170	DCF410P
WP9171	DCF347K
WP9173	DCF059K
WP9174	DCF413P
WP9177	DCF221K
WP9178	DCF510P
WP9183	DCF211K
WP9186	DCF480P
WP9188	DCF522P
WP9189	DCF122K
WP9192	DCF239K
WP9199	DCF161K
WP9200	DCF366P
WP9204	DCF361P
WP9206	DCF512P
WP9208	DCF532P
WP9209	DCF072K
WP9210	DCF499P
WP9212	DCF414P
WP9214	DCF507P
WP9215	DCF044K
WP9220	DCF303P
WP9222	DCF521P
WP9224	DCF561P
WP9226	DCF255P
WP9230	DCF465P
WP9231	DCF236K
WP9232	DCF096P
WP9233	DCF092K
WP9234	DCF280P
WP9238	DCF243P
WP9240	DCF306P
WP9244	DCF266P
WP9246	DCF418P
WP9250	DCF201K
WP9250	DCF488P
WP9252	DCF473P
WP9254	DCF242P
WP9256	DCF560P
WP9260	DCF506P
WP9268	DCF279P
WP9271	DCF345K
WP9276	DCF562P
WP9278	DCF283P

WIX FILTERS	DENSO
WP9282	DCF563P
WP9284	DCF230P
WP9286	DCF210P
WP9288	DCF302P
WP9290	DCF382P
WP9291	DCF385K
WP9293	DCF181K
WP9296	DCF411P
WP9302	DCF486P
WP9308	DCF566P
WP9311	DCF332K
WP9313	DCF300K
WP9314	DCF466P
WP9317	DCF352K
WP9318	DCF479P
WP9319	DCF073K
WP9320	DCF485P
WP9322	DCF467P
WP9324	DCF483P
WP9326	DCF475P
WP9327	DCF340K
WP9328	DCF571P
WP9330	DCF511P
WP9331	DCF081K
WP9336	DCF568P
WP9342	DCF516P
WP9344	DCF284P
WP9348	DCF460P
WP9350	DCF509P
WP9356	DCF564P
WP9359	DCF053K
WP9360	DCF489P
WP9361	DCF365K
WP9362	DCF567P
WP9368	DCF454P
WP9373	DCF053K
WP9378	DCF245P
WP9394	DCF285P
WP9396	DCF227P
WP9396	DCF526P

ZAFFO	DENSO
ASF2656	DCF590P
F5656	DCF590P
WFZ1656	DCF590P
Z014	DCF044K
Z050	DCF081K
Z329	DCF002K
Z329	DCF225K
Z330	DCF068K
Z338	DCF164K
Z348	DCF050K
Z350	DCF044K
Z357	DCF094K
Z359 Couple	DCF015K
Z374	DCF056K
Z376	DCF198K
Z385	DCF200K
Z390	DCF002K
Z394	DCF035K
Z397	DCF460K
Z398	DCF054K
Z403	DCF062K
Z408	DCF345K
Z409	DCF341K
Z411	DCF389K
Z412	DCF351K
Z416	DCF152K
Z416	DCF161K
Z420	DCF343K
Z421	DCF223K
Z422	DCF340K
Z423	DCF458K

ZAFFO	DENSO
Z424	DCF458K
Z426 Couple	DCF048K
Z431	DCF196K
Z436	DCF090K
Z438	DCF067K
Z439 Couple	DCF457K
Z443	DCF239K
Z446	DCF071K
Z451	DCF450K
Z457	DCF383P
Z459	DCF252K
Z461	DCF125K
Z464	DCF072K
Z466	DCF223K
Z468	DCF105K
Z473	DCF052K
Z474	DCF273K
Z474	DCF344K
Z476	DCF234K
Z477	DCF199K
Z481	DCF221K
Z486	DCF347K
Z488	DCF063K
Z489	DCF346K
Z491	DCF106K
Z494	DCF172K
Z495 Couple	DCF170K
Z496 Couple	DCF122K
Z499	DCF420K
Z501 Couple	DCF419K
Z508	DCF453K
Z509	DCF135K
Z510	DCF236K
Z511	DCF239K
Z512	DCF211K
Z513	DCF181K
Z515	DCF450K
Z517	DCF448K
Z518 Couple	DCF231K
Z519	DCF127K
Z520 Couple	DCF168K
Z521 Couple	DCF163K
Z526	DCF201K
Z528	DCF382P
Z528	DCF385K
Z538	DCF080K
Z543	DCF300K
Z549	DCF120K
Z554 Couple	DCF073K
Z555	DCF332K
Z556	DCF053K
Z565	DCF119K
Z583	DCF365K
ZF014	DCF507P
ZF016	DCF537P
ZF318	DCF541P
ZF319	DCF031P
ZF328	DCF517P
ZF329	DCF461P
ZF330	DCF009P
ZF332	DCF268P
ZF332	DCF287P
ZF341	DCF018P
ZF348	DCF508P
ZF350	DCF042P
ZF350	DCF507P
ZF355 Couple	DCF514P
ZF357	DCF500P
ZF359 Couple	DCF402P
ZF368	DCF416P
ZF371	DCF536P
ZF376	DCF482P
ZF380	DCF270P

Cabin Air Filter

Cross Reference Chart - OE

ZAFFO	DENSO
ZF381	DCF502P
ZF383	DCF109P
ZF385	DCF476P
ZF386	DCF474P
ZF387	DCF083P
ZF388	DCF075P
ZF389	DCF076P
ZF391 Couple	DCF187P
ZF396	DCF190P
ZF397	DCF493P
ZF399	DCF400P
ZF403	DCF016P
ZF404 Couple	DCF262P
ZF409	DCF412P
ZF411	DCF389K
ZF413	DCF227P
ZF413	DCF526P
ZF414	DCF357P
ZF419	DCF513P
ZF421	DCF486P
ZF422	DCF475P
ZF424	DCF462P
ZF424	DCF576P
ZF427 Couple	DCF550P
ZF428	DCF463P
ZF429	DCF492P
ZF433	DCF517P
ZF436	DCF504P
ZF437	DCF540P
ZF444	DCF255P
ZF447	DCF366P
ZF448	DCF410P
ZF450	DCF361P
ZF451	DCF497P
ZF453 Couple	DCF303P
ZF454	DCF446P
ZF456 Couple	DCF512P
ZF457	DCF383P
ZF457	DCF469P
ZF458 Couple	DCF064P
ZF459	DCF144P
ZF462	DCF210P
ZF462	DCF408P
ZF464	DCF532P
ZF467 Couple	DCF266P
ZF470	DCF413P
ZF472	DCF466P
ZF473	DCF449P
ZF474	DCF467P
ZF475	DCF469P
ZF476	DCF477P
ZF477	DCF510P
ZF478	DCF480P
ZF483 Couple	DCF279P
ZF485 Couple	DCF283P
ZF487	DCF499P
ZF487	DCF580P
ZF488	DCF061P
ZF489	DCF405P
ZF491	DCF471P
ZF494	DCF521P
ZF496 Couple	DCF522P
ZF497	DCF255P
ZF497	DCF561P
ZF501 Couple	DCF403P
ZF502	DCF563P
ZF503	DCF242P
ZF505	DCF284P
ZF506	DCF243P
ZF507	DCF486P
ZF508	DCF452P
ZF510	DCF465P
ZF511	DCF353P

ZAFFO	DENSO
ZF513	DCF305P
ZF515	DCF096P
ZF516	DCF562P
ZF517	DCF506P
ZF519	DCF516P
ZF522 Couple	DCF268P
ZF526	DCF488P
ZF528	DCF382P
ZF528	DCF385K
ZF529	DCF377P
ZF530	DCF330P
ZF532	DCF245P
ZF540	DCF560P
ZF541	DCF473P
ZF542	DCF454P
ZF544	DCF566P
ZF546	DCF483P
ZF547	DCF374P
ZF548	DCF567P
ZF554 Couple	DCF479P
ZF557	DCF371P
ZF558	DCF230P
ZF558	DCF375P
ZF561 Couple	DCF423P
ZF562	DCF263P
ZF564	DCF571P
ZF566	DCF509P
ZF572	DCF485P
ZF573	DCF460P
ZF577	DCF564P
ZF581 Couple	DCF568P
ZF584 COUPLE	DCF570P
ZF587	DCF582P
ZF588	DCF376P
ZF591	DCF586P
ZF594	DCF565P
ZF596	DCF573P
ZF600	DCF574P
ZF603	DCF569P
ZF617	DCF418P
ZF620	DCF380P
ZF621	DCF581P
ZF622	DCF471P
ZF624	DCF583P
ZF626	DCF580P
ZF629	DCF579P
ZF630	DCF589P
ZF631	DCF587P
ZF633	DCF575P
ZF637	DCF584P
ZF641	DCF578P
ZF646	DCF576P
ZF648	DCF577P
ZF649	DCF588P
ZF653	DCF585P
ZF656	DCF590P

DENSO Photo Guide



Cabin Air Filter

Photo Guide

DCF002K

Length: 282mm Width: 206mm Height: 30mm

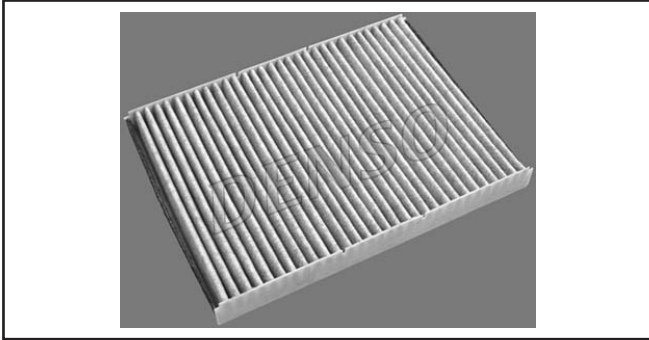

DCF018P

Length: 215mm Width: 210mm Height: 19mm

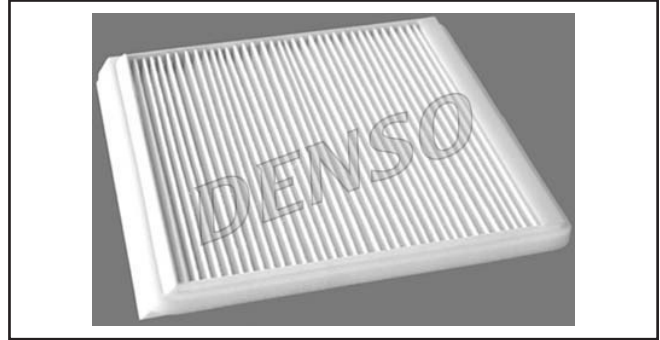

DCF009P

Length: 275mm Width: 219mm Height: 54mm

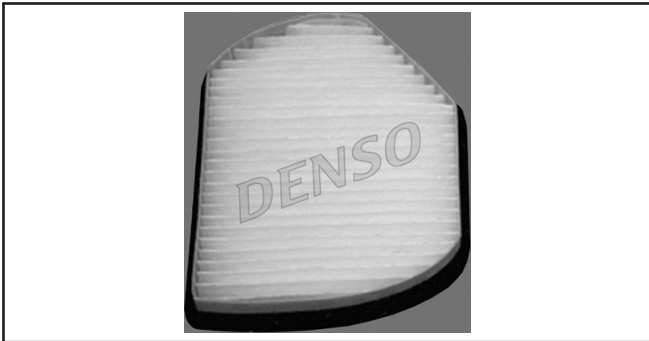

DCF031P

Length: 340mm Width: 198mm Height: 17mm

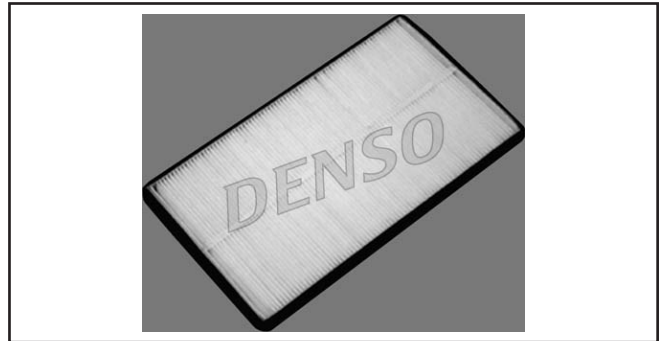

DCF015K

Length: 266mm Width: 201mm Height: 30mm

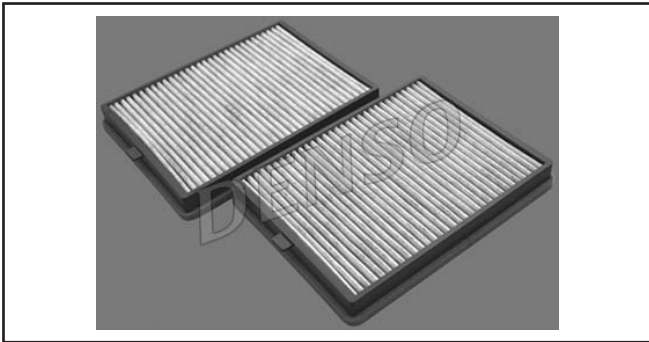

DCF035K

Length: 364mm Width: 252mm Height: 31mm

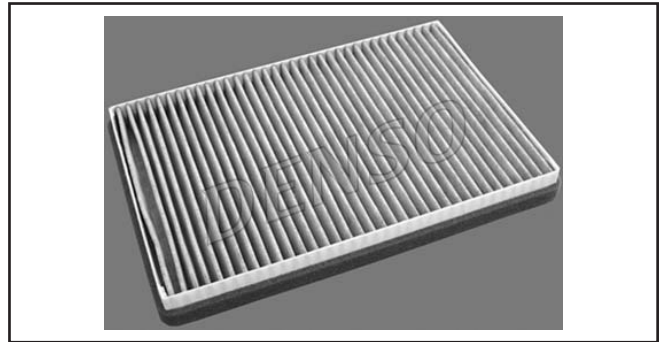

DCF016P

Length: 670mm Width: 125mm Height: 25mm

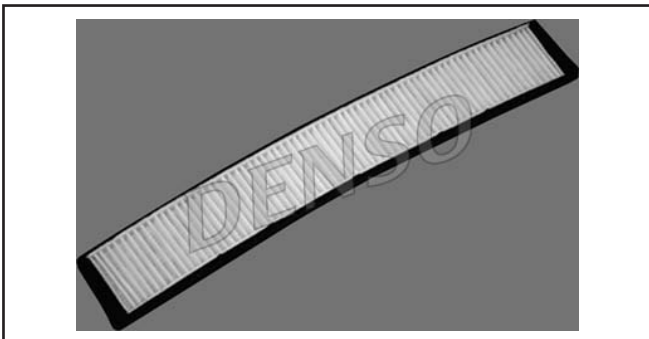

DCF042P

Length: 240mm Width: 170mm Height: 17mm

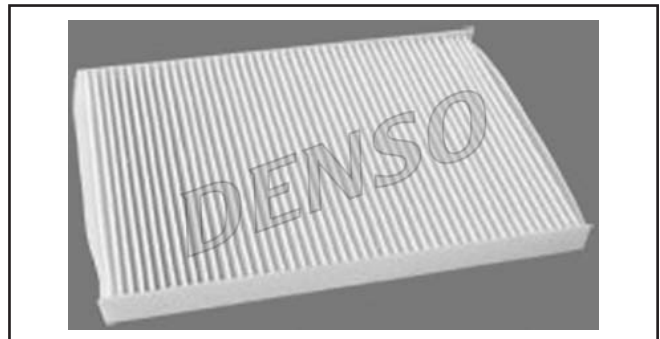

Cabin Air Filter | Photo Guide

DCF044K

Length: 290mm Width: 160mm Height: 30mm

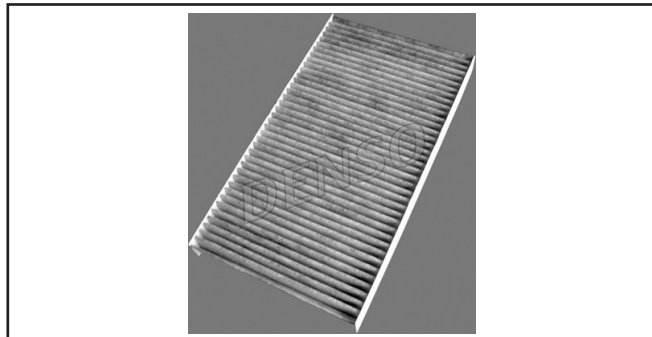

DCF053K

Length: 214mm Width: 241,5mm Height: 67,5mm

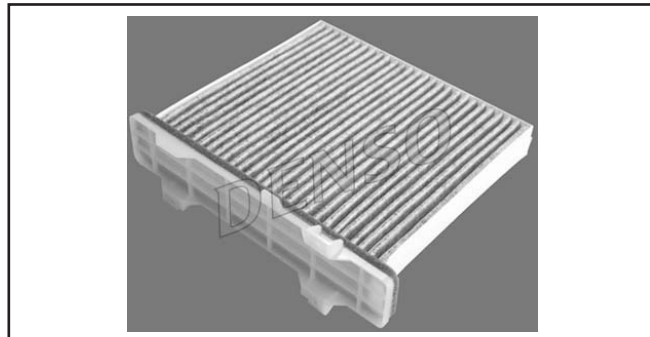

DCF048K

Length: 174mm Width: 138mm Height: 30mm

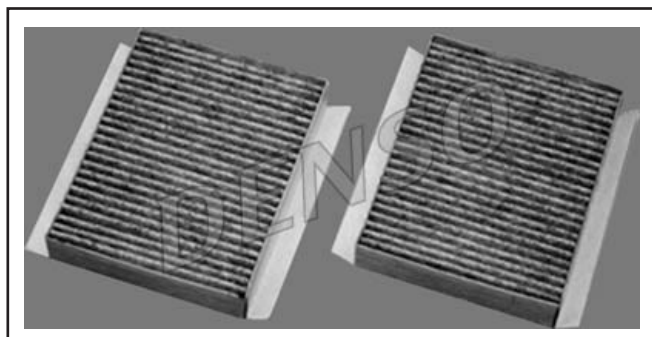

DCF054K

Length: 300mm Width: 204mm Height: 30mm

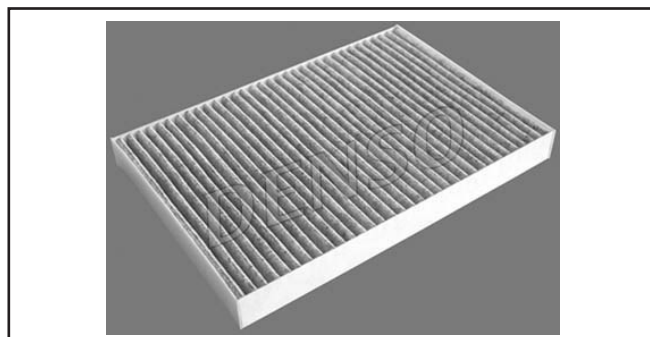

DCF050K

Length: 382mm Width: 142mm Height: 25mm

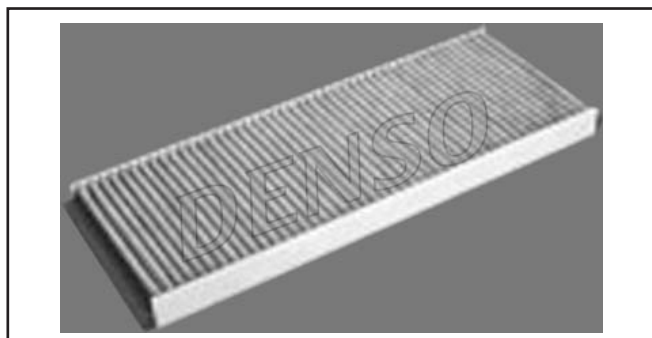

DCF056K

Length: 310mm Width: 195mm Height: 30mm

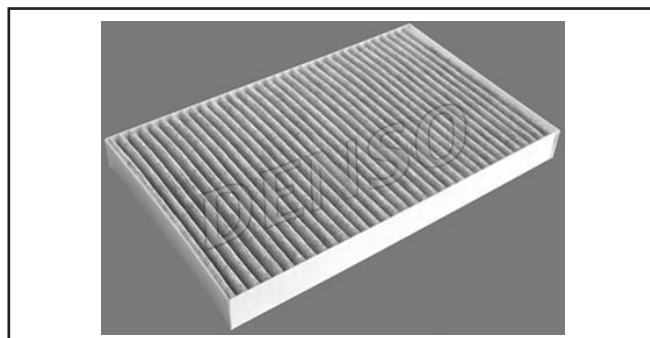

DCF052K

Length: 269mm Width: 207mm Height: 33mm

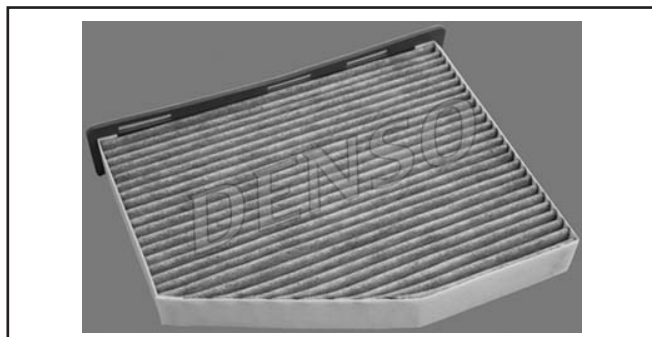

DCF059K

Length: 405mm Width: 212mm Height: 58mm

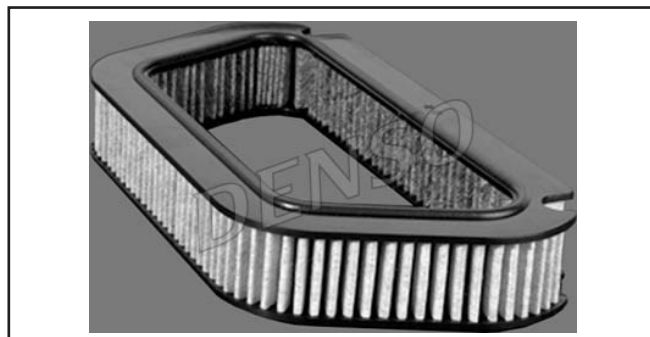

Cabin Air Filter

Photo Guide

DCF061P

Length: 468mm Width: 120mm Height: 30mm

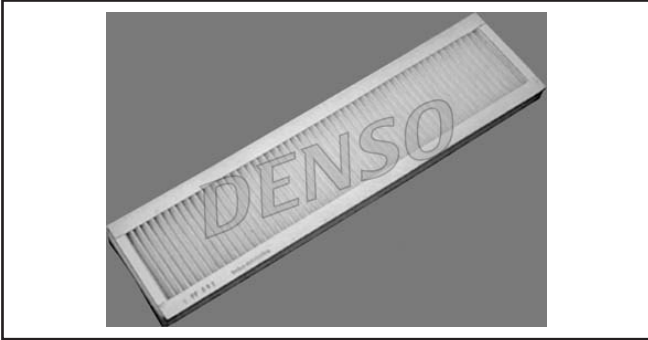

DCF065K

Length: 314mm Width: 164mm Height: 30mm

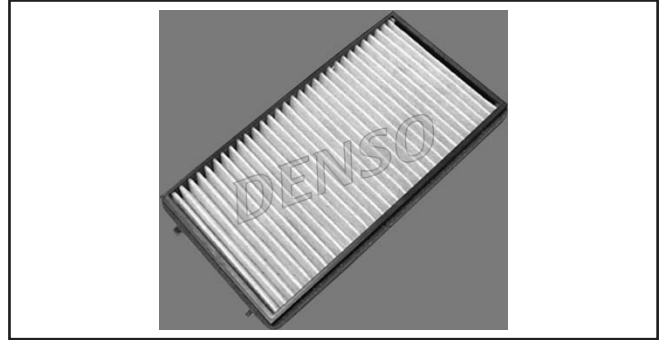

DCF062K

Length: 660mm Width: 95mm Height: 20mm

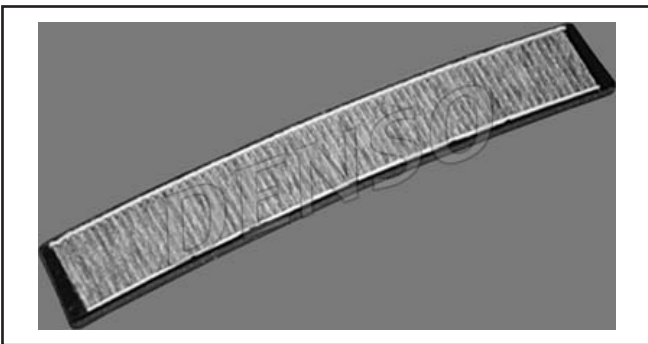

DCF067K

Length: 310mm Width: 236mm Height: 23mm

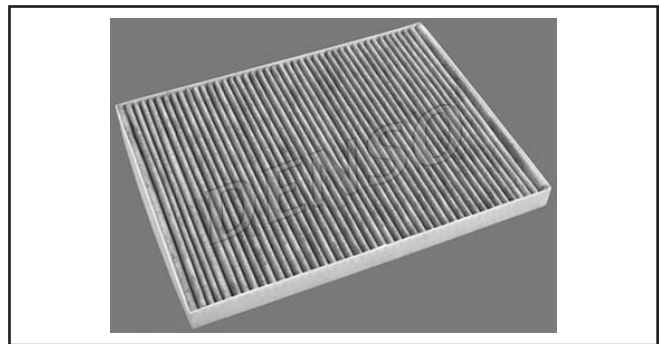

DCF063K

Length: 468mm Width: 120mm Height: 30mm

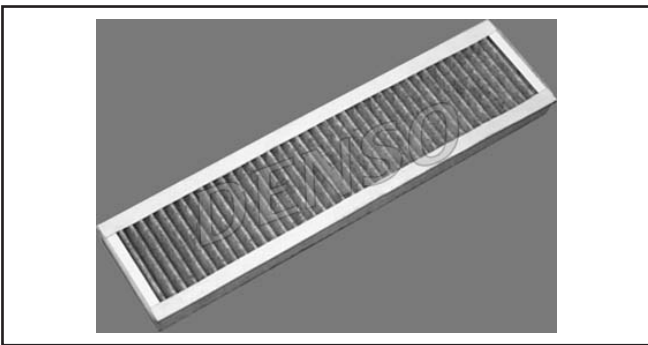

DCF068K

Length: 263mm Width: 205mm Height: 48mm

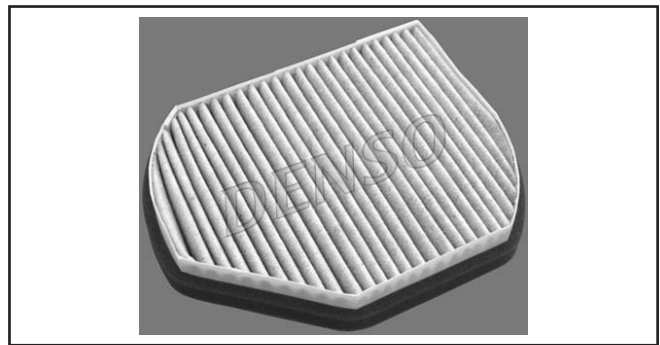

DCF064P

Length: 314mm Width: 164mm Height: 30mm

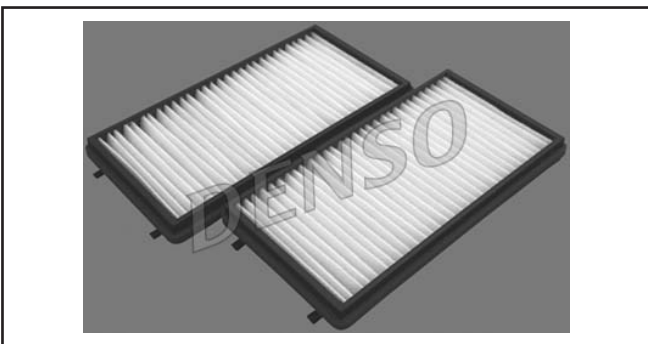

DCF069K

Length: 301mm Width: 208mm Height: 23mm

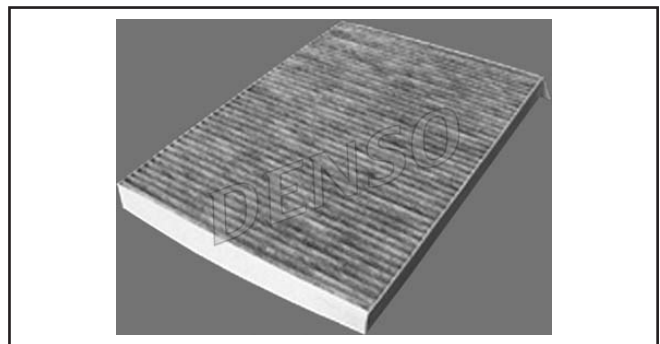

Cabin Air Filter

Photo Guide

DCF071K

Length: 285mm Width: 175mm Height: 36mm

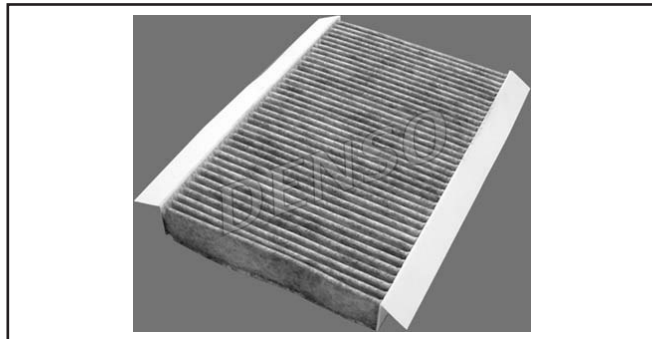

DCF076P

Length: 260mm Width: 200mm Height: 25mm



DCF072K

Length: 405mm Width: 164mm Height: 32mm

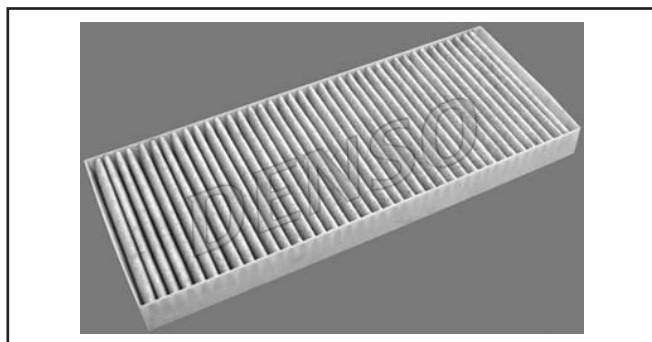

DCF078P

Length: 260mm Width: 200mm Height: 25mm

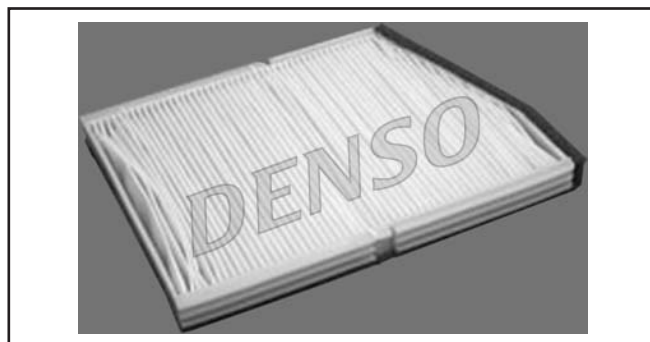

DCF073K

Length: 292mm Width: 96mm Height: 30mm

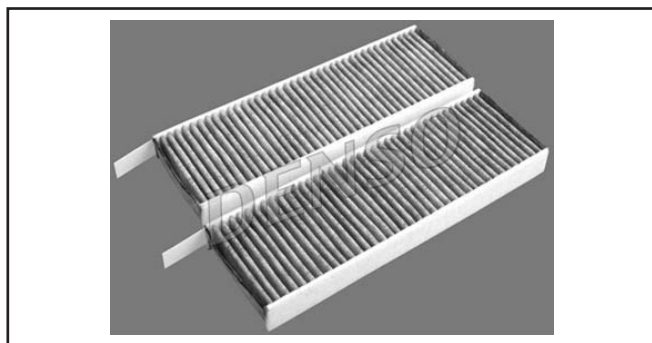

DCF080K

Length: 309mm Width: 213mm Height: 30mm

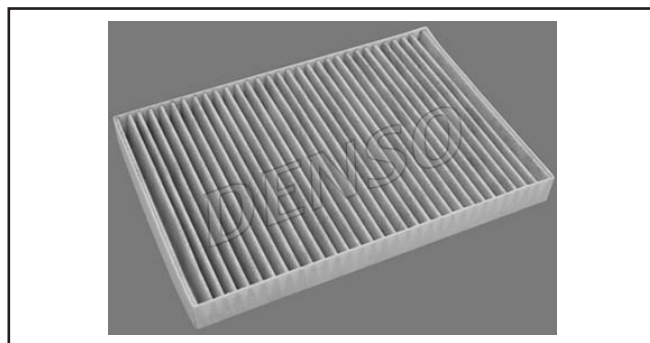

DCF075P

Length: 215mm Width: 187mm Height: 25mm



DCF081K

Length: 352mm Width: 234mm Height: 35mm

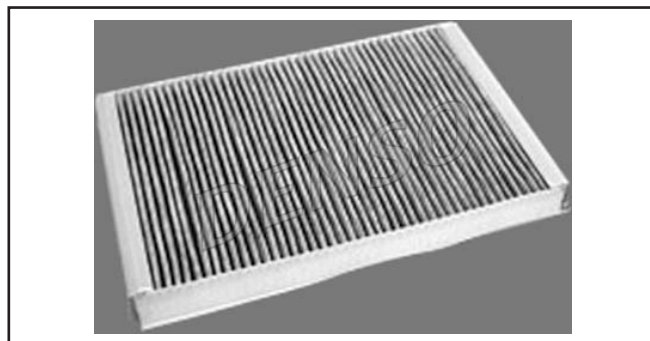

Cabin Air Filter

Photo Guide

DCF083P

Length: 270mm Width: 160mm Height: 35mm

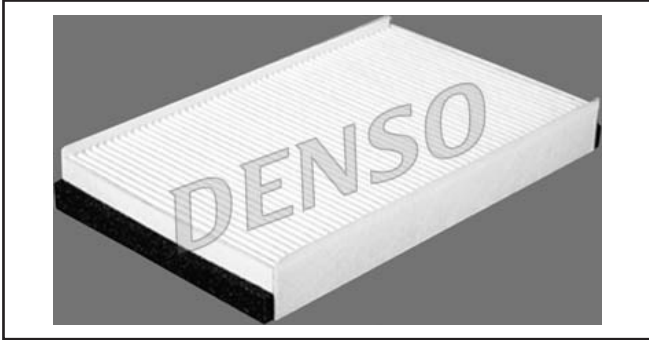

DCF096P

Length: 832mm Width: 122mm Height: 20mm

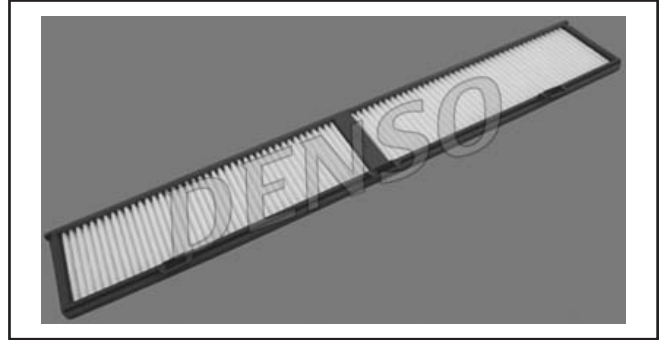

DCF086P

Length: 234mm Width: 213mm Height: 12mm

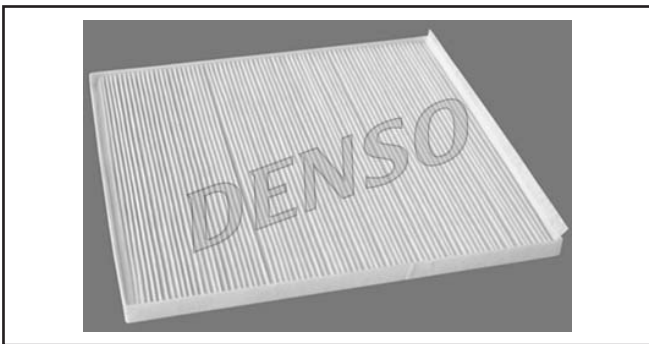

DCF105K

Length: 240mm Width: 189mm Height: 35mm

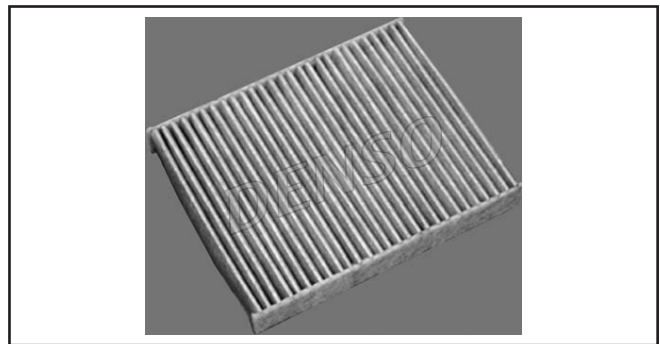

DCF090K

Length: 222mm Width: 207mm Height: 30mm

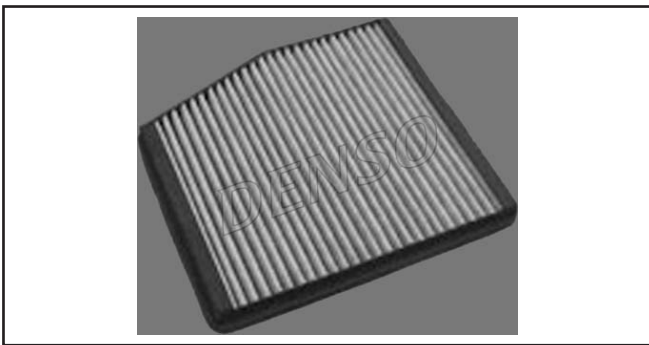

DCF106K

Length: 240mm Width: 209mm Height: 35mm

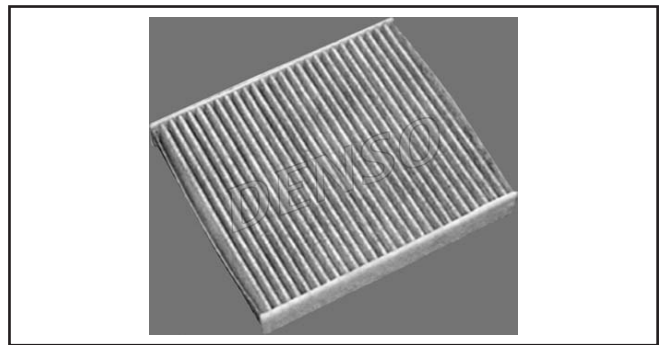

DCF094K

Length: 536mm Width: 111mm Height: 30mm

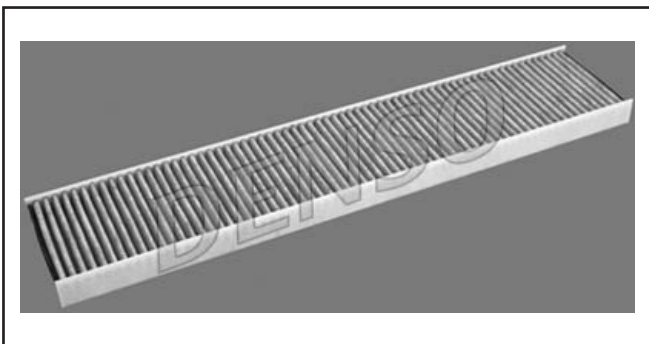

DCF109P

Length: 212mm Width: 211mm Height: 30mm



Cabin Air Filter

Photo Guide

DCF118K

Length: 245mm Width: 182mm Height: 43mm



DCF125K

Length: 320mm Width: 190mm Height: 30mm

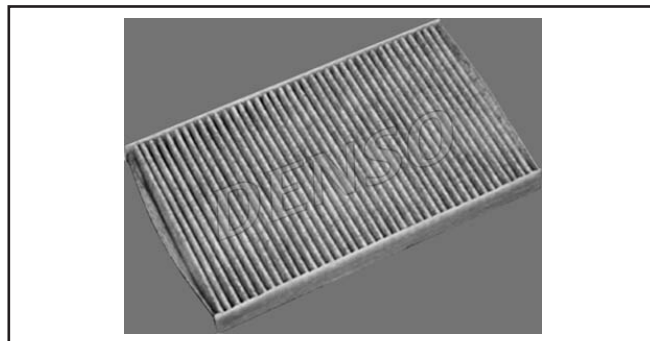

DCF119K

Length: 250mm Width: 182mm Height: 45mm

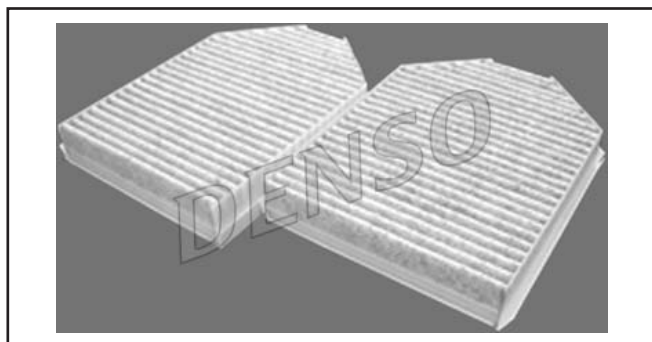

DCF127K

Length: 269mm Width: 157mm Height: 30mm

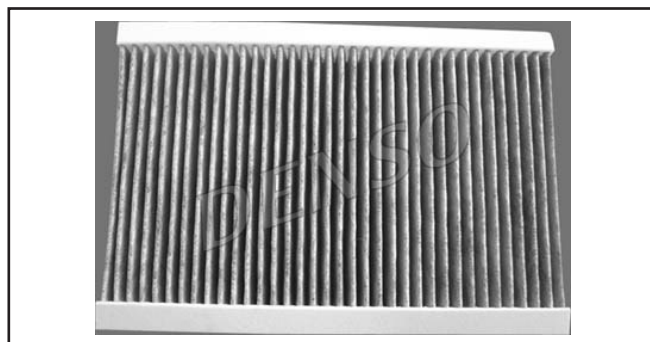

DCF120K

Length: 217mm Width: 195mm Height: 25mm

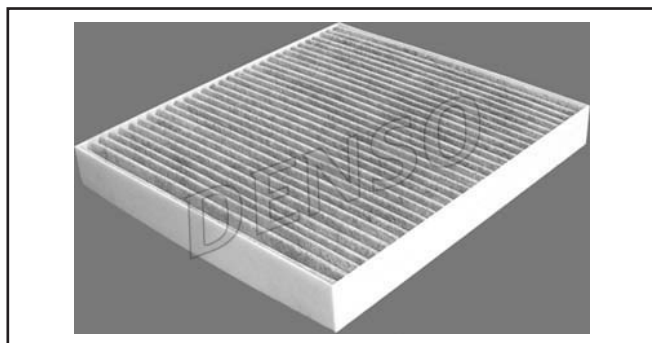

DCF135K

Length: 250mm Width: 215mm Height: 40mm



DCF122K

Length: 297mm Width: 99mm Height: 30mm

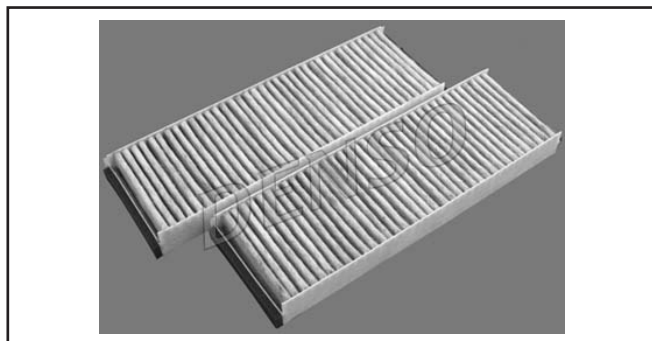

DCF141P

Length: 391mm Width: 257mm Height: 43mm



Cabin Air Filter

Photo Guide

DCF142P

Length: 391mm Width: 257mm Height: 43mm



DCF153K

Length: 332mm Width: 189mm Height: 25mm



DCF144P

Length: 310mm Width: 255mm Height: 35mm

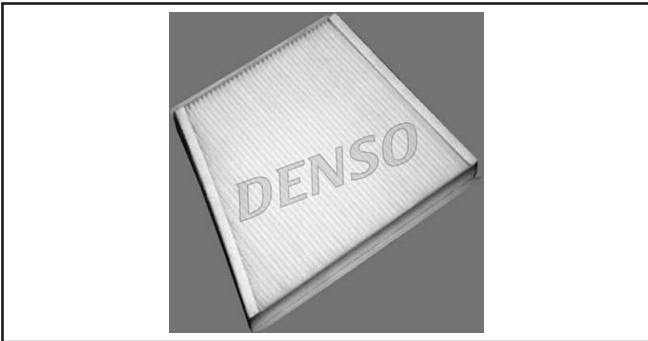

DCF159P

Length: 374mm Width: 76mm Height: 31mm



DCF145P

Length: 310mm Width: 255mm Height: 35mm



DCF160K

Length: 213mm Width: 189mm Height: 40mm



DCF152K

Length: 332mm Width: 189mm Height: 25mm

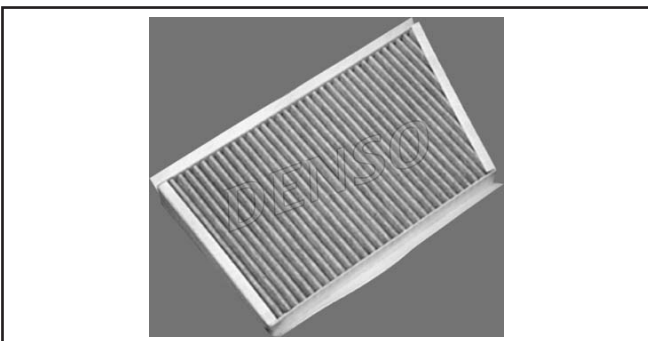

DCF161K

Length: 184mm Width: 136mm Height: 40mm



Cabin Air Filter

Photo Guide

DCF162K

Length: 201mm Width: 175mm Height: 40mm

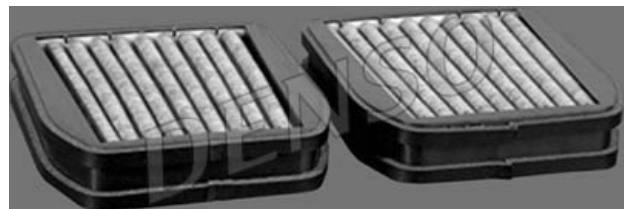

DCF170K

Length: 360mm Width: 178mm Height: 35mm

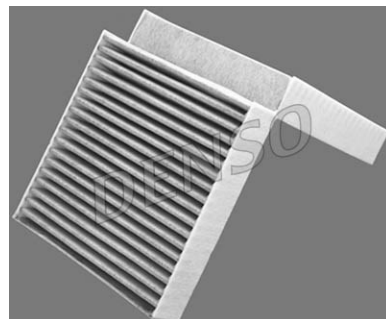

DCF163K

Length: 254mm Width: 134mm Height: 40mm

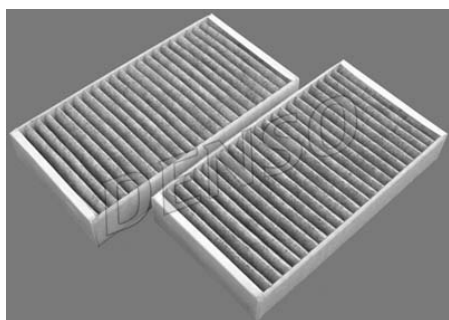

DCF172K

Length: 347mm Width: 203mm Height: 33mm

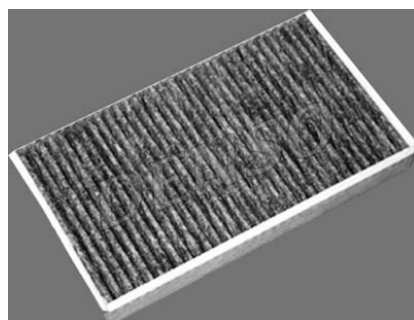

DCF164K

Length: 396mm Width: 257mm Height: 43mm

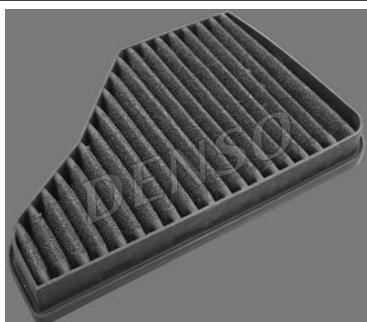

DCF181K

Length: 203mm Width: 178mm Height: 40mm

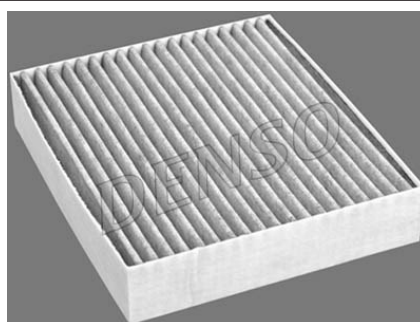

DCF168K

Length: 262mm Width: 184mm Height: 30mm

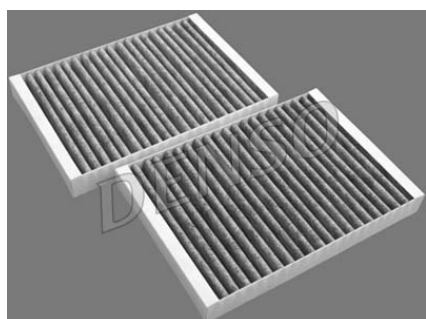

DCF187P

Length: 270mm Width: 220mm Height: 24mm



Cabin Air Filter

Photo Guide

DCF188K

Length: 244mm Width: 84mm Height: 27mm

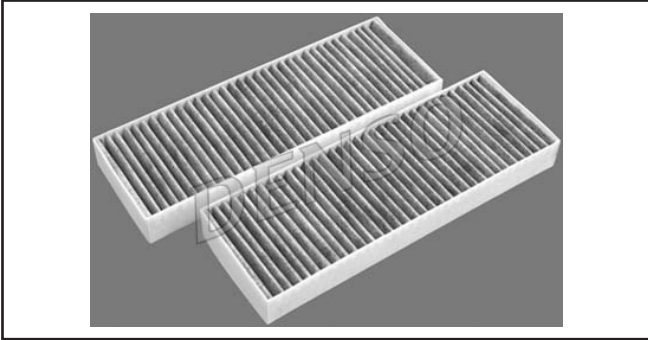

DCF198K

Length: 258mm Width: 231mm Height: 30mm

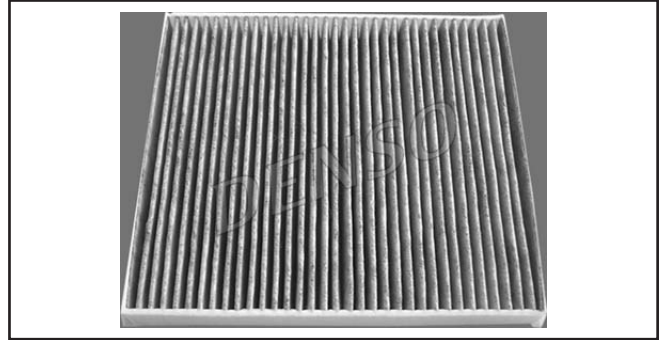

DCF190P

Length: 262mm Width: 210mm Height: 20mm

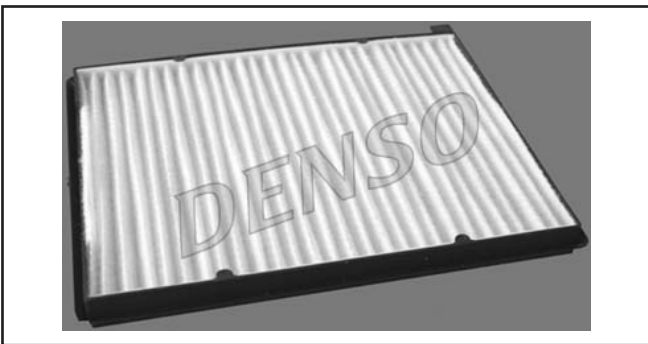

DCF199K

Length: 329mm Width: 210mm Height: 32mm



DCF193P

Length: 225mm Width: 206mm Height: 25mm



DCF200K

Length: 292mm Width: 198mm Height: 30mm

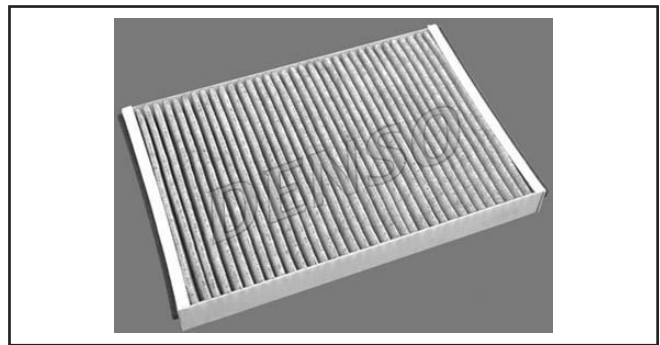

DCF196K

Length: 290mm Width: 226mm Height: 17mm

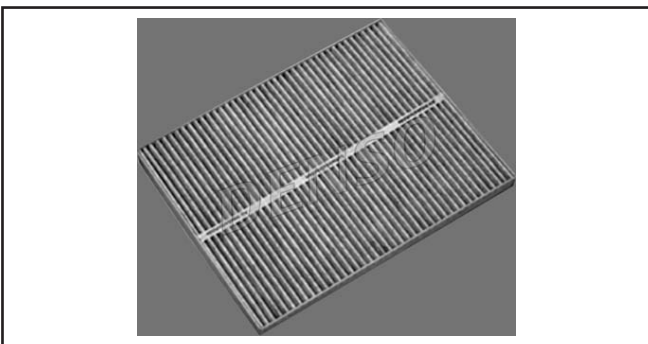

DCF201K

Length: 265mm Width: 215mm Height: 21mm

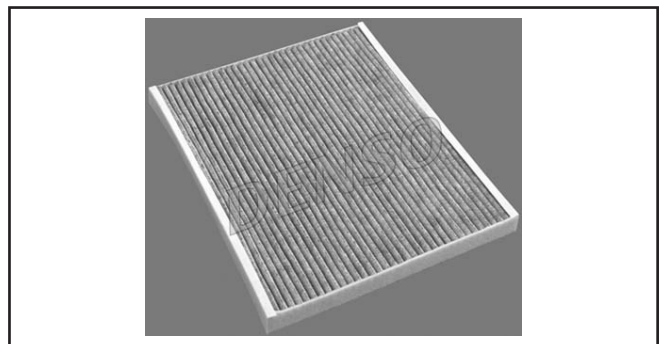

Cabin Air Filter

Photo Guide

DCF210P

Length: 405mm Width: 164mm Height: 32mm



DCF223K

Length: 331mm Width: 163mm Height: 30mm

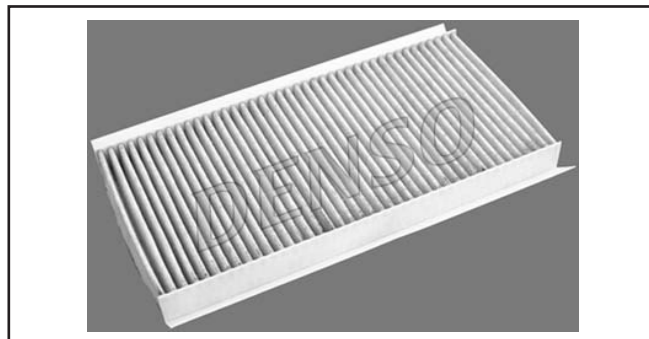

DCF211K

Length: 315mm Width: 150mm Height: 40mm

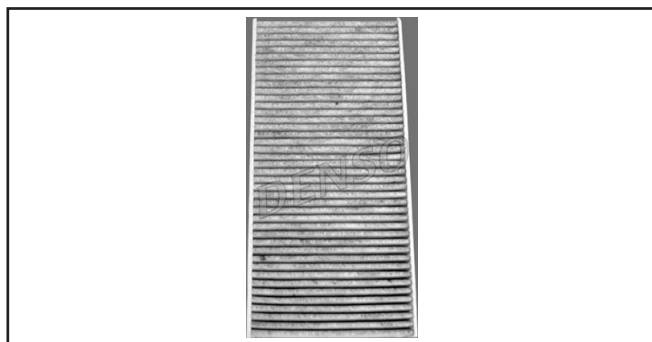

DCF225K

Length: 279mm Width: 207mm Height: 25mm

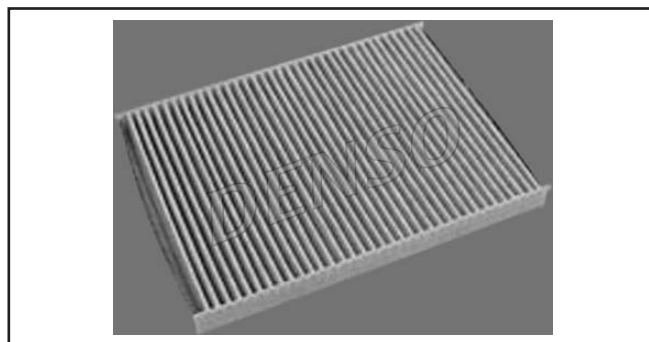

DCF219P

Length: 390mm Width: 120mm Height: 30mm



DCF227P

Length: 230mm Width: 192mm Height: 17mm



DCF221K

Length: 374mm Width: 142mm Height: 50mm

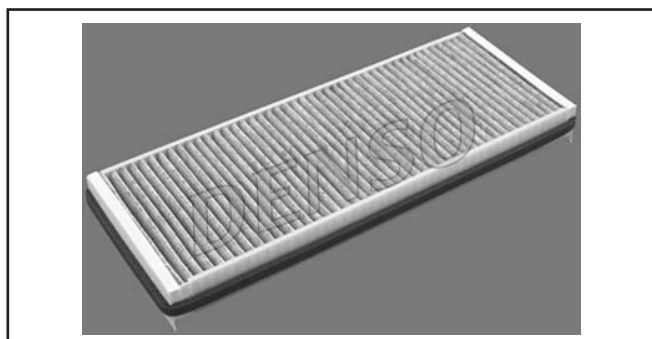

DCF230P

Length: 270mm Width: 200mm Height: 37mm

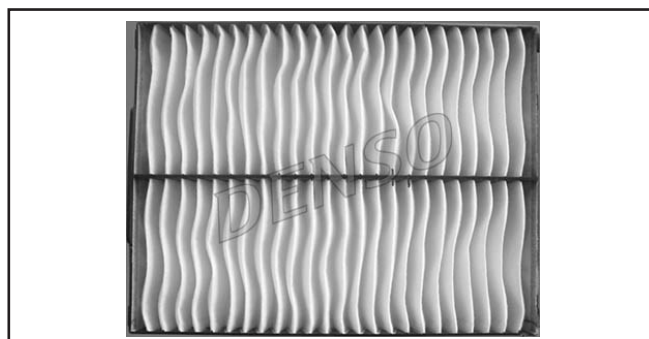

Cabin Air Filter

Photo Guide

DCF231K

Length: 172mm Width: 221mm Height: 30mm

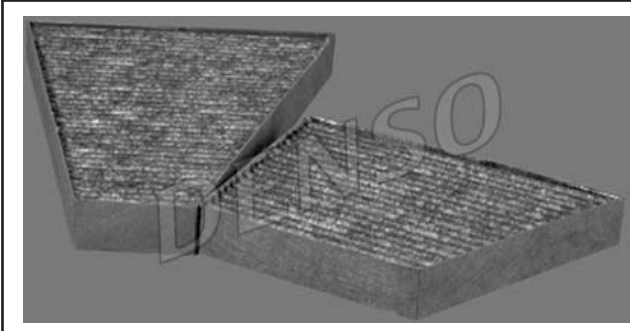

DCF242P

Length: 249mm Width: 204mm Height: 19mm

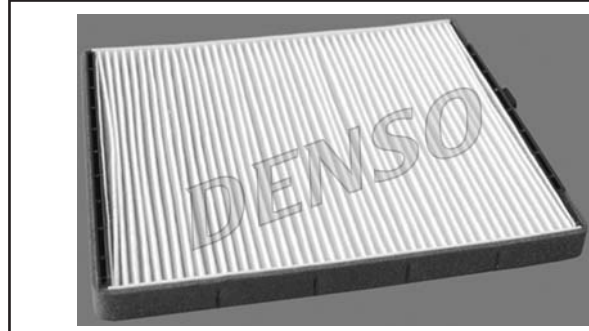

DCF234K

Length: 278mm Width: 219mm Height: 34mm

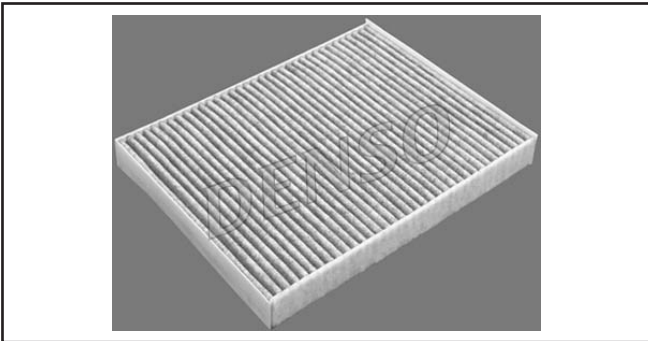

DCF243P

Length: 211mm Width: 232mm Height: 25mm

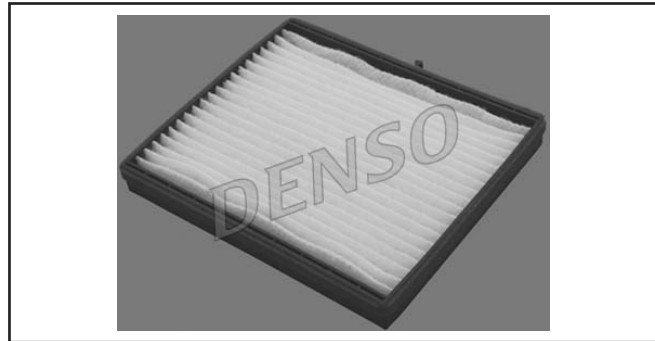

DCF236K

Length: 232,5mm Width: 209mm Height: 35mm

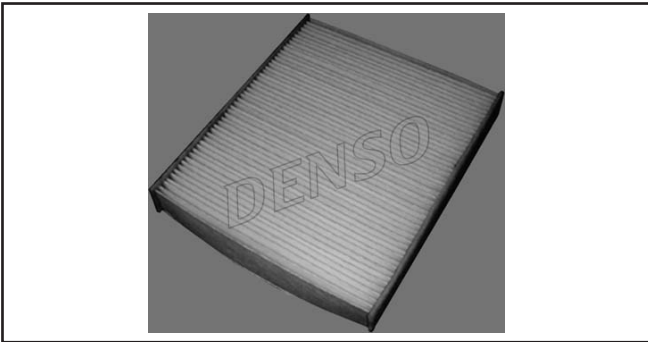

DCF245P

Length: 210mm Width: 199mm Height: 10mm

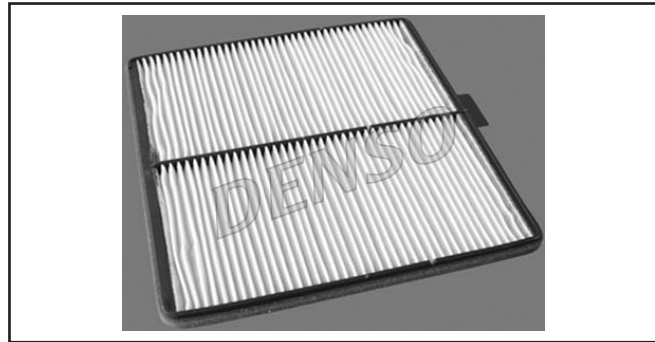

DCF239K

Length: 216mm Width: 216mm Height: 17mm

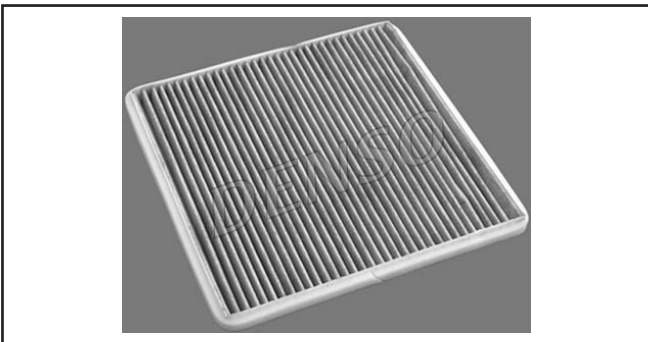

DCF252K

Length: 310mm Width: 257mm Height: 34mm

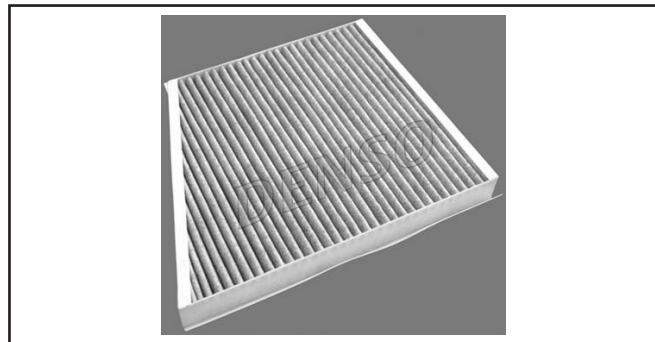

Cabin Air Filter

Photo Guide

DCF255P

Length: 296mm Width: 212mm Height: 25mm

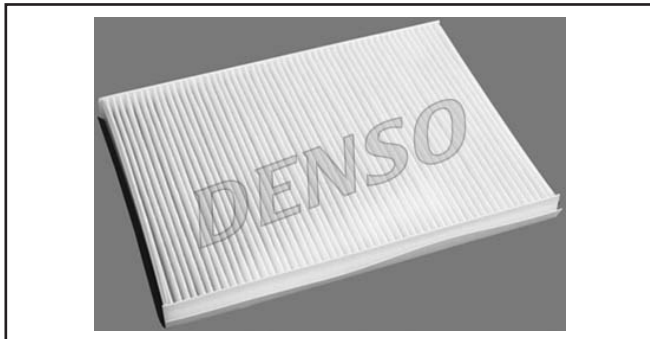

DCF268P

Length: 265mm Width: 191mm Height: 31mm

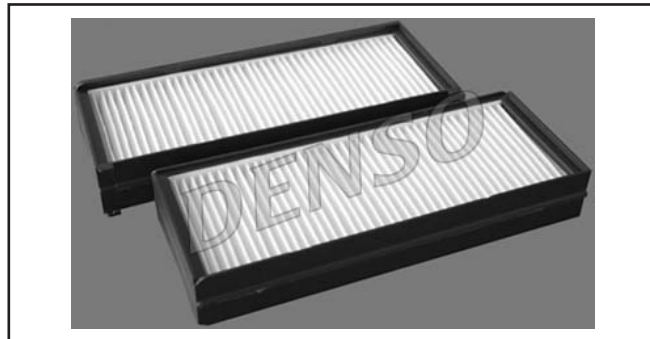

DCF262P

Length: 368mm Width: 175mm Height: 31mm

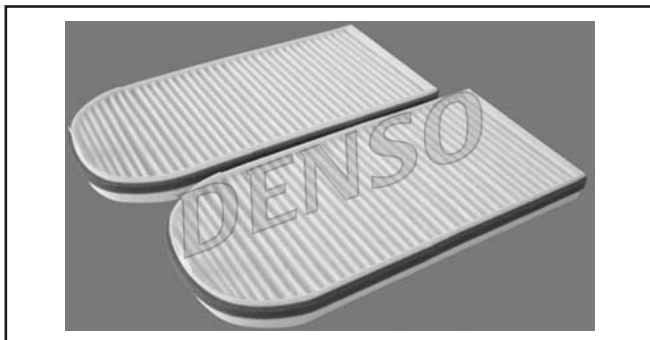

DCF270P

Length: 234,5mm Width: 222mm Height: 19mm

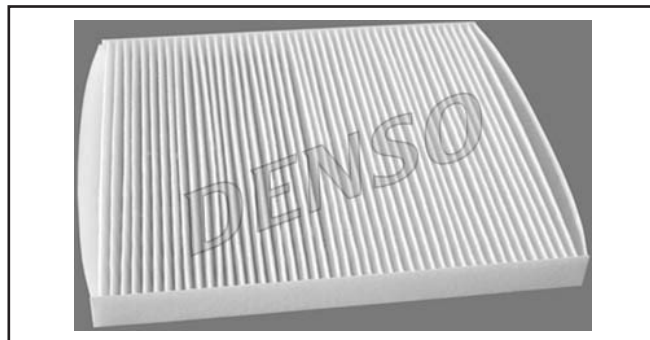

DCF263P

Length: 246mm Width: 172mm Height: 20mm

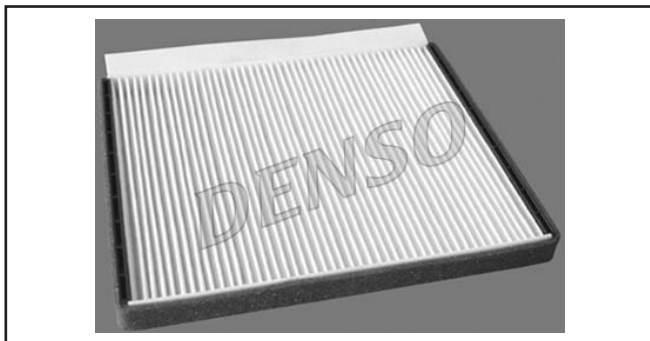

DCF273K

Length: 216mm Width: 200mm Height: 30mm

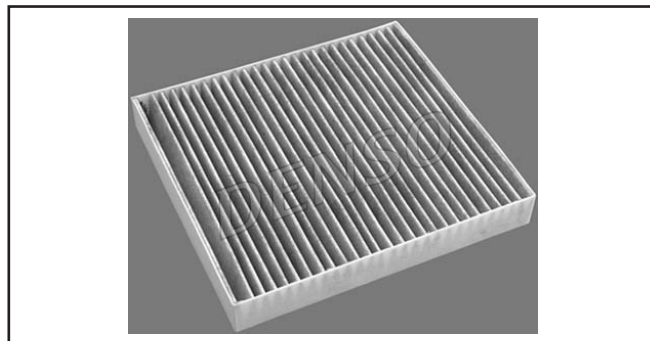

DCF266P

Length: 250mm Width: 100mm Height: 12mm

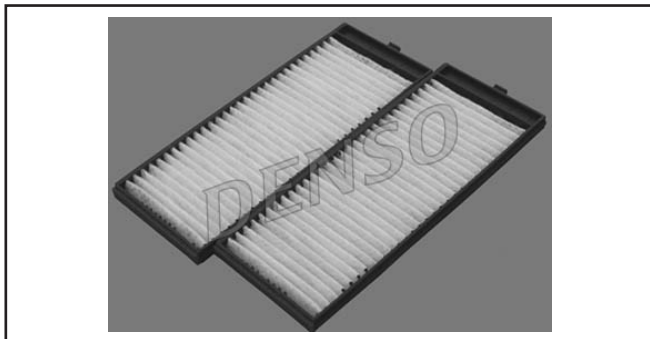

DCF279P

Length: 260mm Width: 113mm Height: 20mm

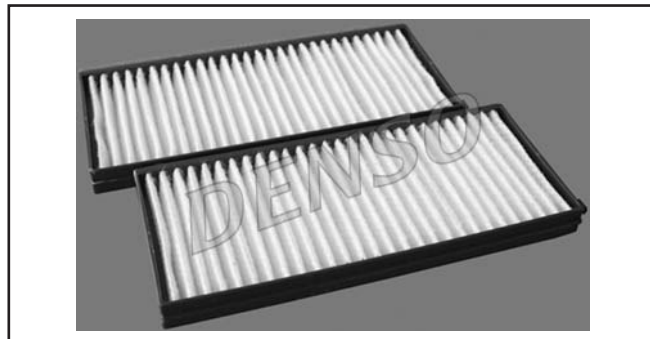

Cabin Air Filter

Photo Guide

DCF280P

Length: 266mm Width: 225mm Height: 21mm

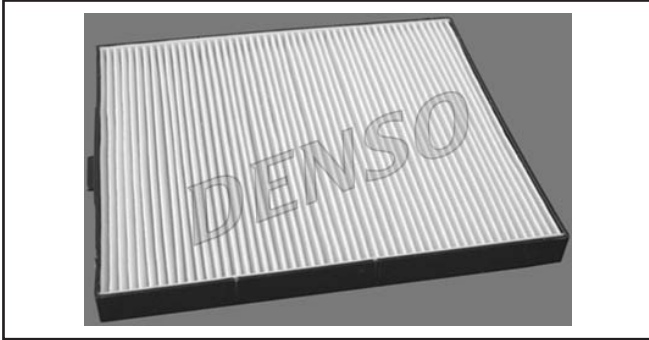

DCF286P

Length: 217mm Width: 195,8mm Height: 24,9mm

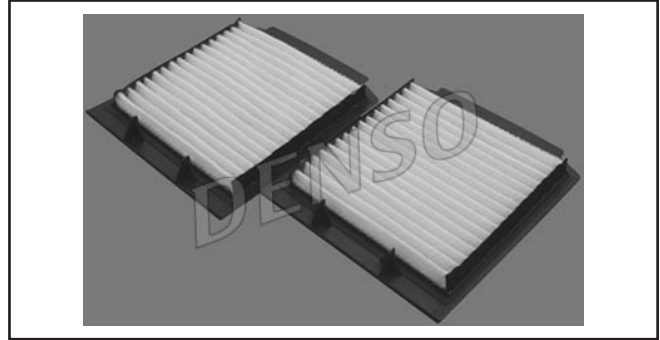

DCF283P

Length: 235mm Width: 106mm Height: 25mm

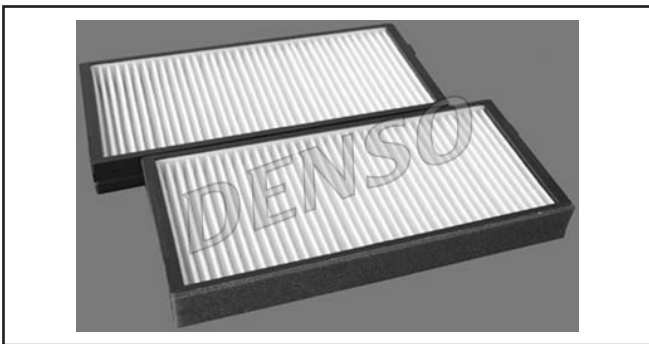

DCF287P

Length: 194mm Width: 262mm Height: 68mm

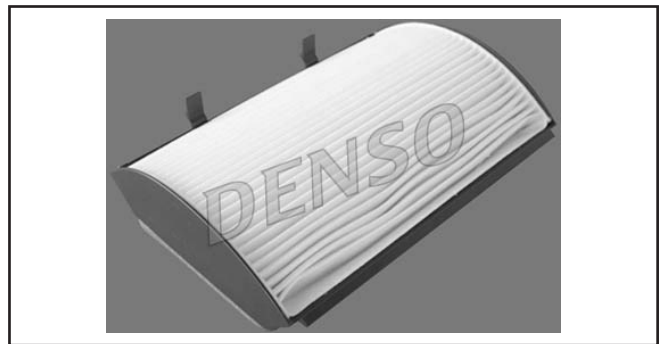

DCF284P

Length: 185mm Width: 181mm Height: 15mm

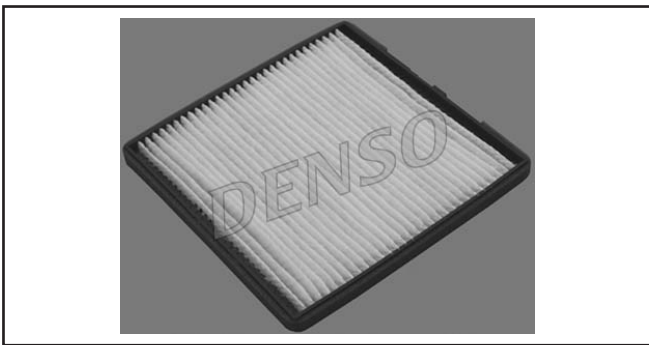

DCF295P

Length: 242mm Width: 190mm Height: 53mm

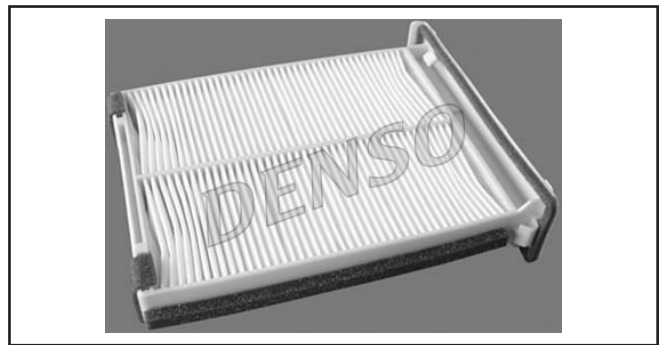

DCF285P

Length: 241mm Width: 105mm Height: 20mm

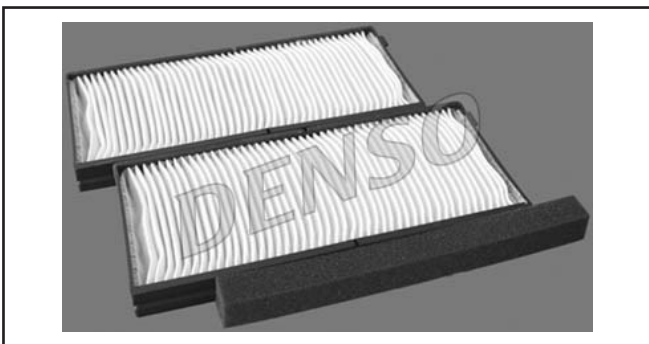

DCF300K

Length: 228mm Width: 227mm Height: 74mm

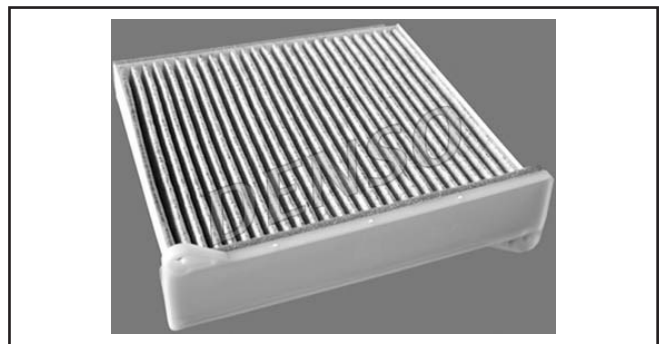

Cabin Air Filter

Photo Guide

DCF302P

Length: 202mm Width: 180mm Height: 51mm



DCF309P

Length: 224mm Width: 207mm Height: 35mm

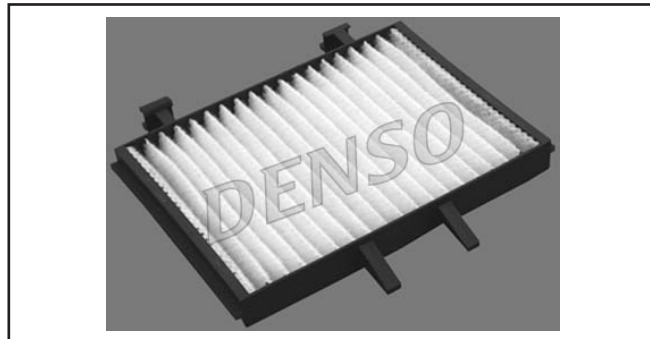

DCF303P

Length: 227mm Width: 107mm Height: 37mm

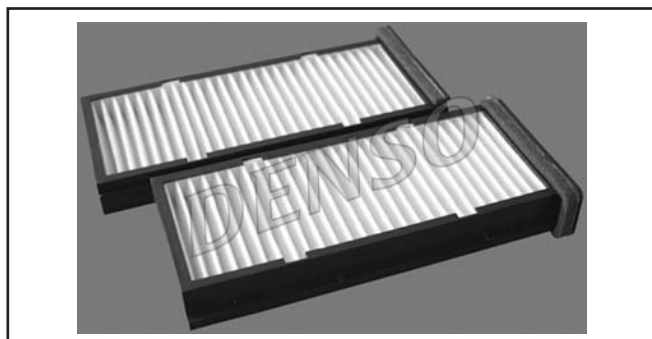

DCF326P

Length: 217mm Width: 112mm Height: 40mm

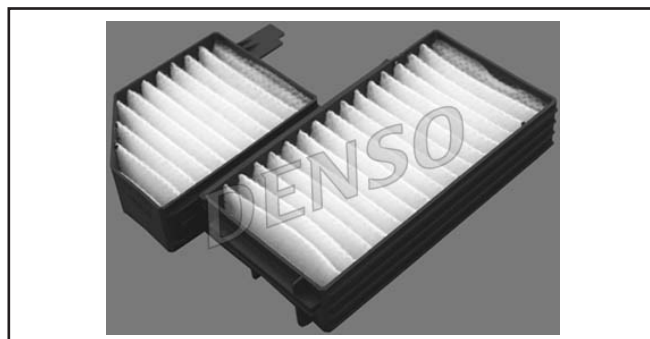

DCF305P

Length: 178mm Width: 203mm Height: 40mm

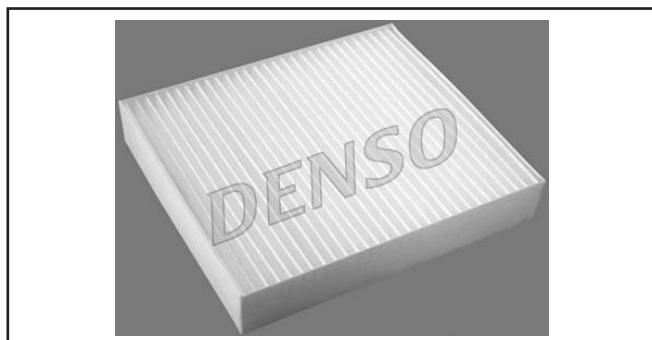

DCF330P

Length: 199mm Width: 188mm Height: 17mm

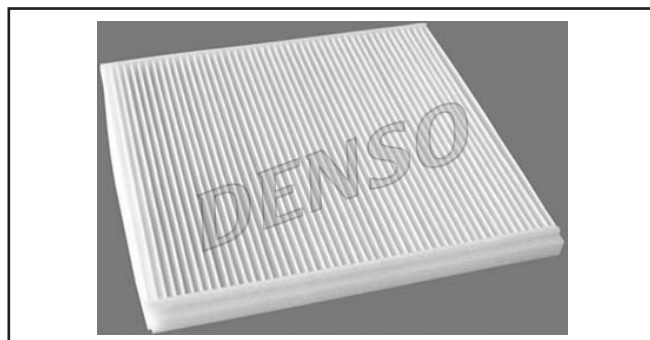

DCF306P

Length: 268mm Width: 175mm Height: 58mm

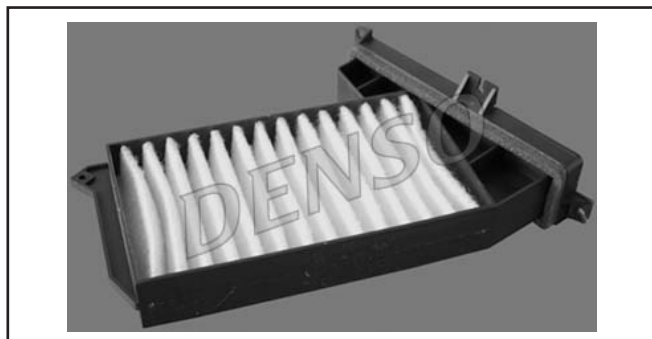

DCF332K

Length: 376mm Width: 176mm Height: 37mm

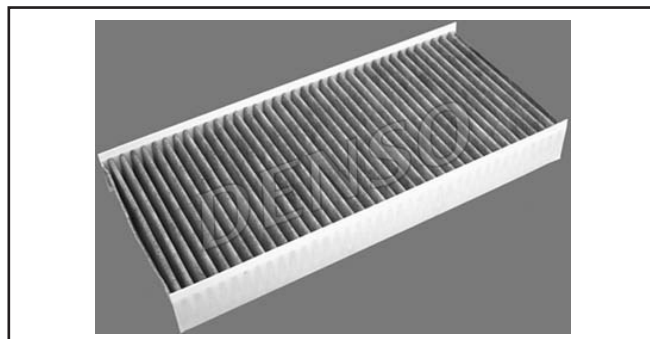

Cabin Air Filter

Photo Guide

DCF336K

Length: 214mm Width: 241,5mm Height: 67,5mm

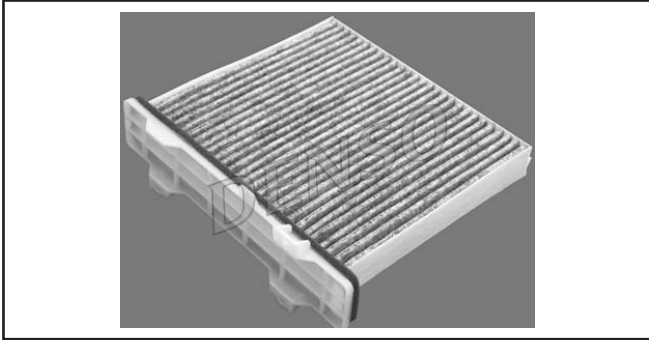

DCF344K

Length: 216mm Width: 200mm Height: 30mm

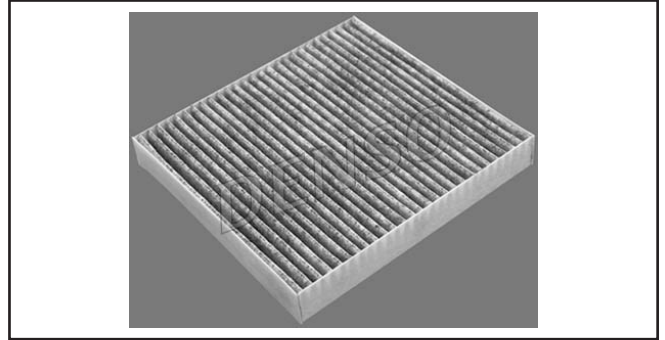

DCF340K

Length: 537mm Width: 254mm Height: 31mm

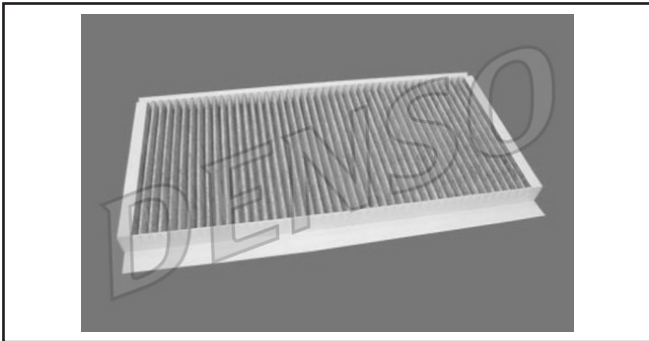

DCF345K

Length: 196mm Width: 204mm Height: 40mm

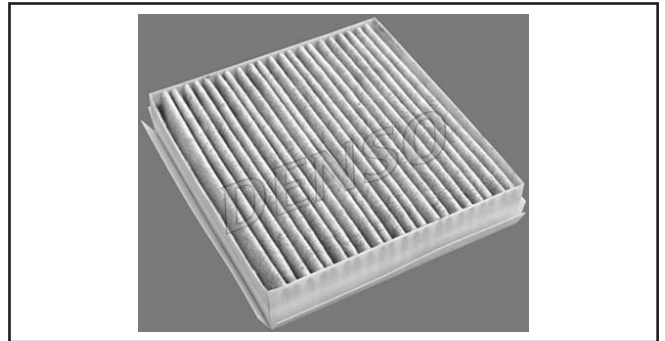

DCF341K

Length: 236mm Width: 209mm Height: 41mm

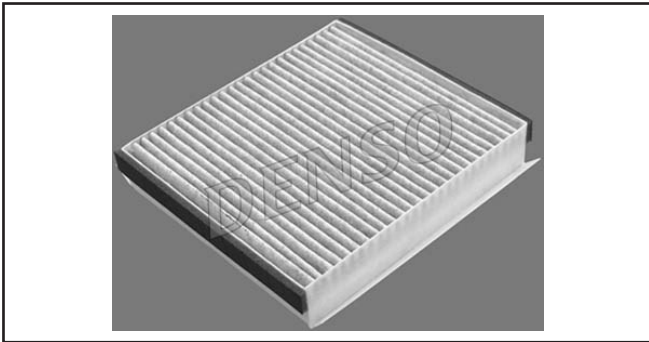

DCF346K

Length: 343,2mm Width: 164mm Height: 73,5mm

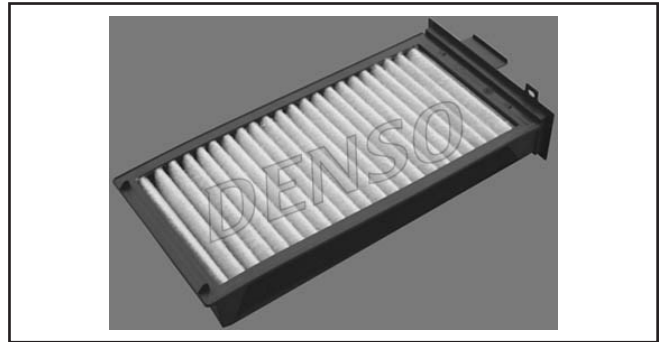

DCF343K

Length: 278mm Width: 248mm Height: 38mm

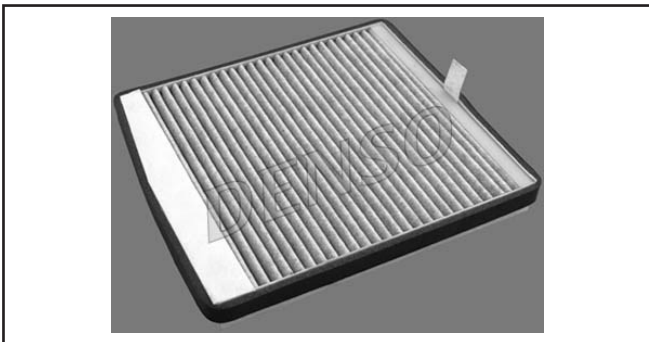

DCF347K

Length: 530mm Width: 144mm Height: 40mm

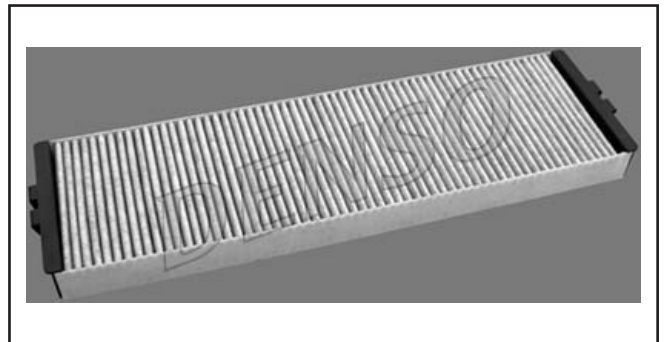

Cabin Air Filter

Photo Guide

DCF351K

Length: 320mm Width: 160mm Height: 30mm

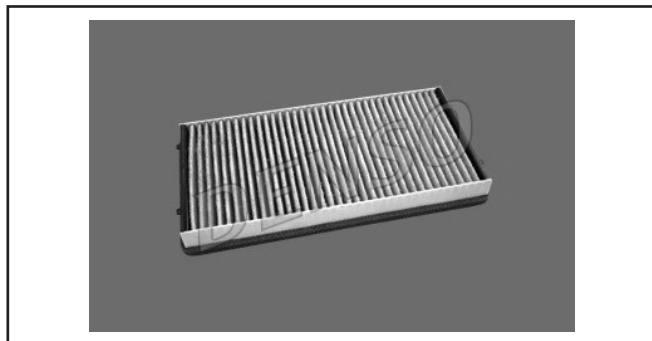

DCF357P

Length: 216mm Width: 196mm Height: 17mm



DCF352K

Length: 278mm Width: 248mm Height: 38mm

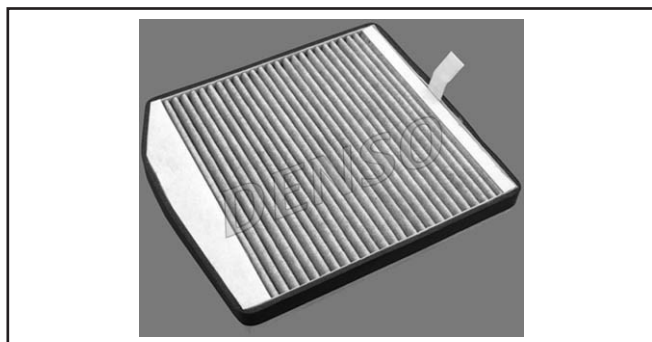

DCF361P

Length: 292mm Width: 239mm Height: 19mm

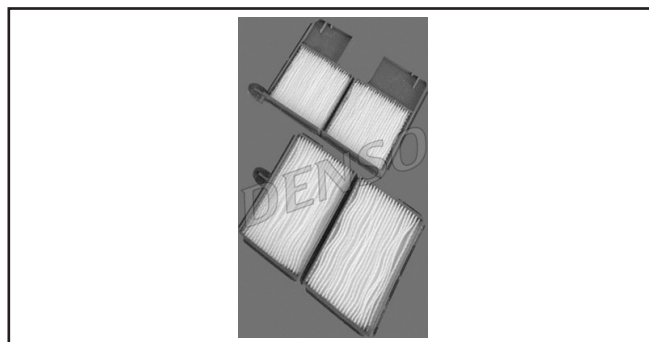

DCF353P

Length: 216mm Width: 216mm Height: 18mm



DCF365K

Length: 240mm Width: 190mm Height: 22mm

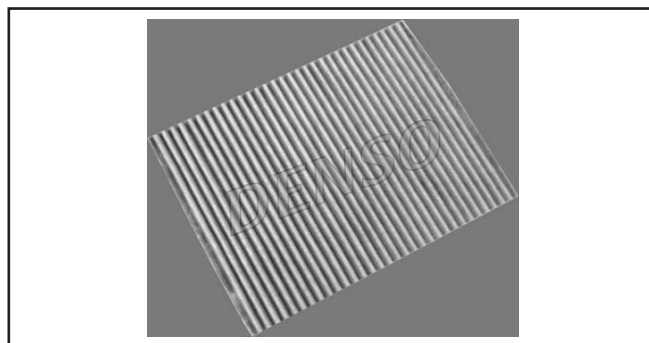

DCF354P

Length: 235mm Width: 215mm Height: 19mm



DCF366P

Length: 270mm Width: 236mm Height: 34mm

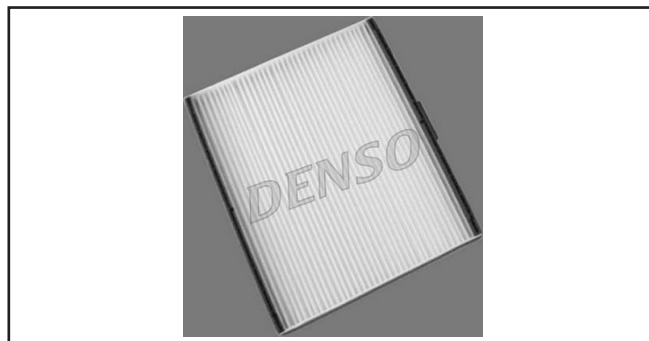

Cabin Air Filter

Photo Guide

DCF368P

Length: 292mm Width: 192mm Height: 30mm



DCF376P

Length: 225mm Width: 250mm Height: 22mm



DCF370K

Length: 265mm Width: 190mm Height: 20mm

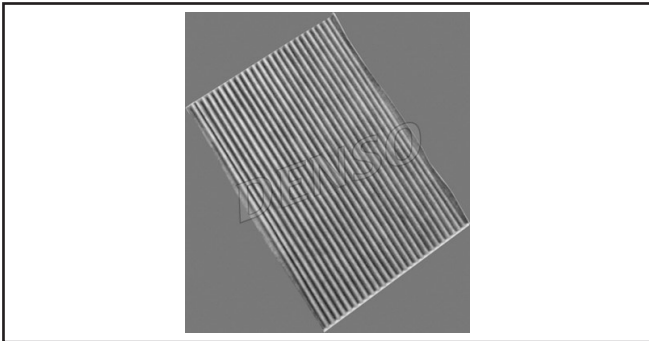

DCF377P

Length: 210mm Width: 304mm Height: 33mm



DCF371P

Length: 275mm Width: 205mm Height: 30mm

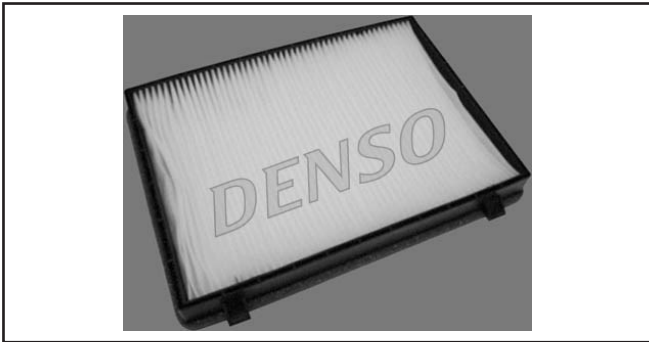

DCF378P

Length: 175mm Width: 202mm Height: 48mm



DCF374P

Length: 225mm Width: 250mm Height: 22mm



DCF379P

Length: 217mm Width: 185mm Height: 20mm



Cabin Air Filter

Photo Guide

DCF380P

Length: 235mm Width: 205mm Height: 30mm



DCF384K

Length: 216mm Width: 216mm Height: 19mm



DCF381P

Length: 195mm Width: 163mm Height: 23mm



DCF385K

Length: 195mm Width: 216.5mm Height: 29mm

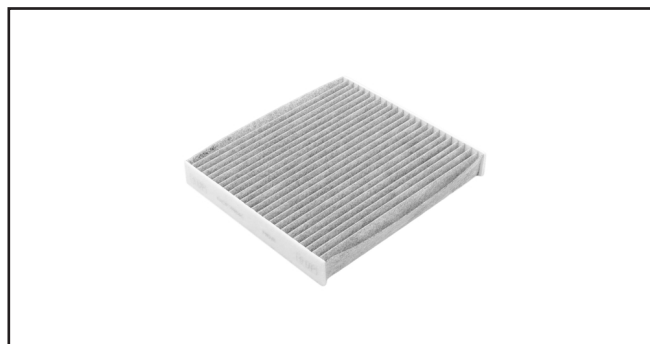

DCF382P

Length: 195mm Width: 216.5mm Height: 29mm



DCF386P

Length: 215.5mm Width: 188mm Height: 29mm



DCF383P

Length: 196mm Width: 216mm Height: 19mm



DCF387K

Length: 215.5mm Width: 188mm Height: 29mm



Cabin Air Filter

Photo Guide

DCF388P

Length: 210mm Width: 238mm Height: 29mm



DCF403P

Length: 327mm Width: 180mm Height: 30mm

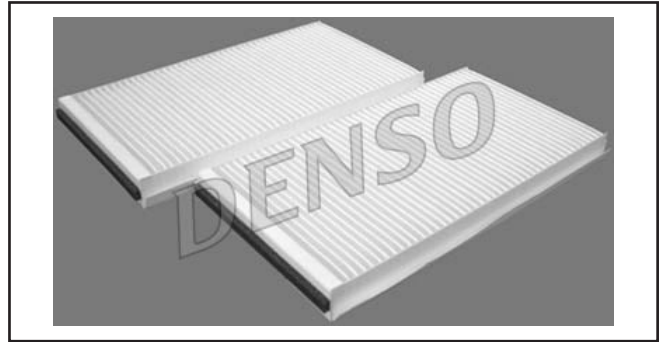

DCF389K

Length: 223mm Width: 204mm Height: 29mm

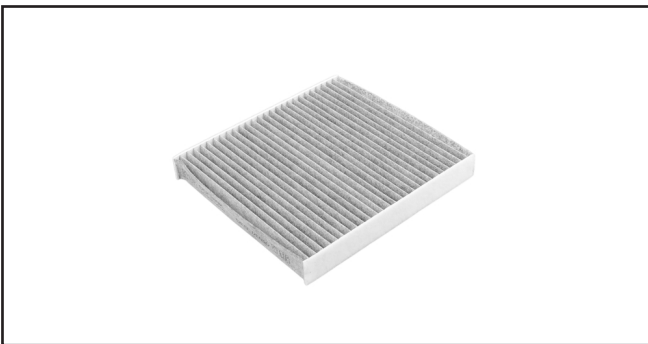

DCF405P

Length: 343,2mm Width: 164mm Height: 73,5mm

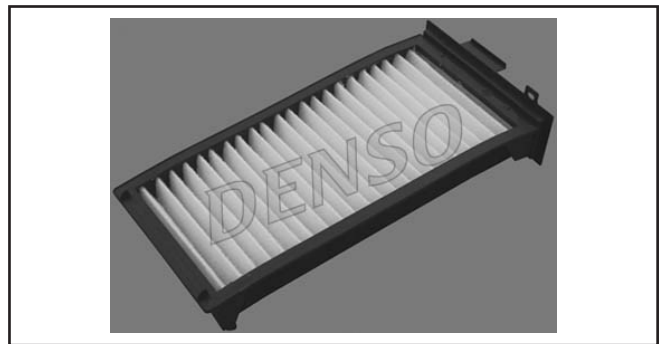

DCF400P

Length: 280mm Width: 202,8mm Height: 28mm

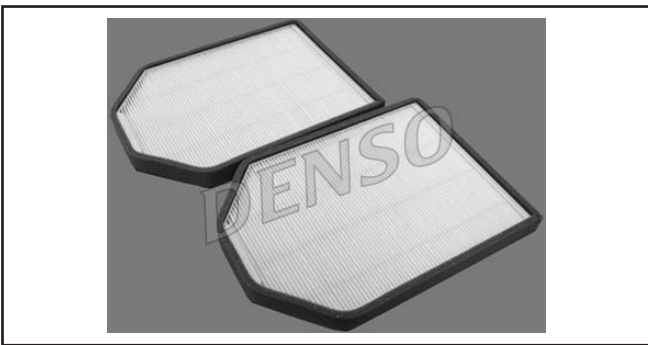

DCF408P

Length: 255mm Width: 201mm Height: 24mm

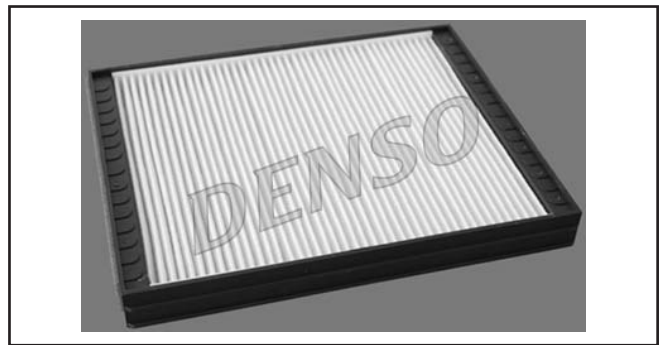

DCF402P

Length: 266mm Width: 201mm Height: 31mm

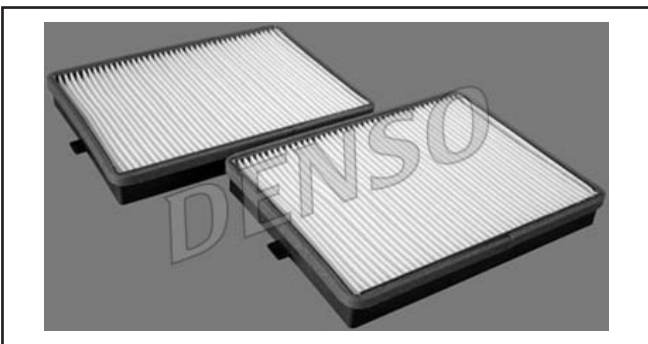

DCF410P

Length: 263mm Width: 193mm Height: 37mm

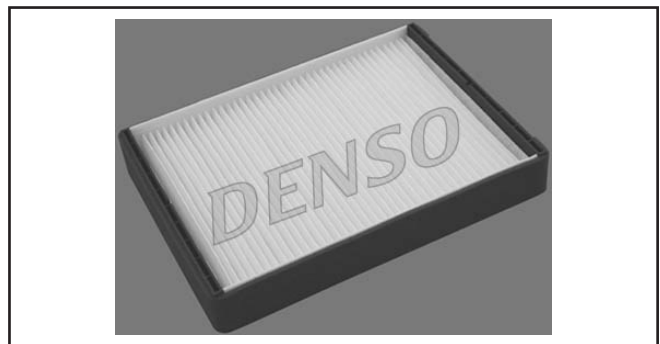

Cabin Air Filter

Photo Guide

DCF411P

Length: 243,5mm Width: 218,7mm Height: 74,8mm

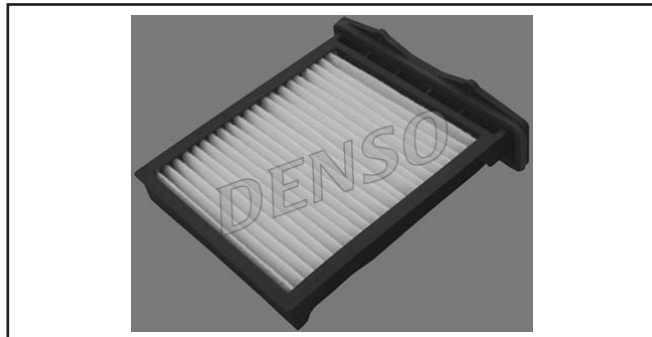

DCF416P

Length: 252mm Width: 227mm Height: 19mm

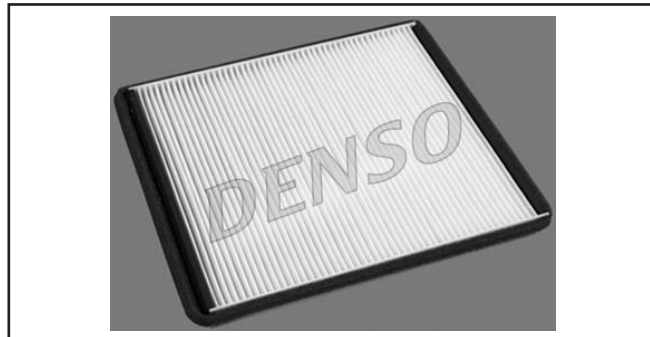

DCF412P

Length: 235mm Width: 224mm Height: 40mm



DCF418P

Length: 340mm Width: 191,5mm Height: 45mm

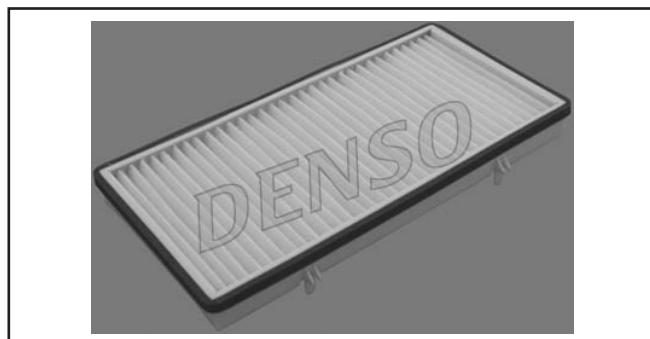

DCF413P

Length: 274mm Width: 187mm Height: 40,3mm

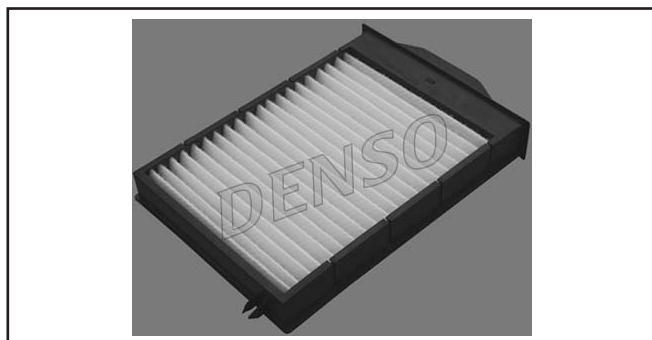

DCF419K

Length: 327mm Width: 180mm Height: 30mm

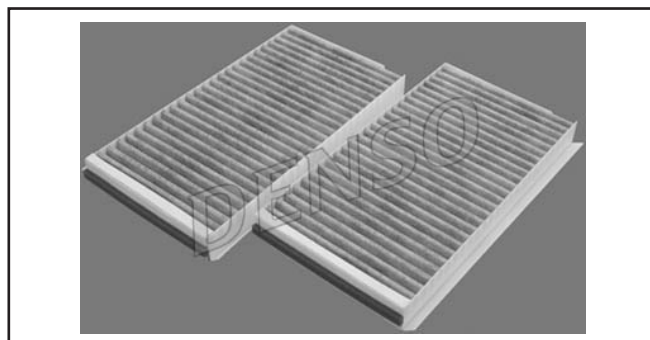

DCF414P

Length: 238,5mm Width: 241,5mm Height: 47mm

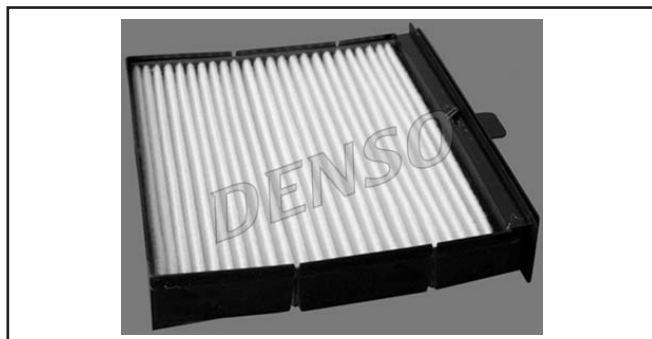

DCF420K

Length: 252mm Width: 245mm Height: 32mm

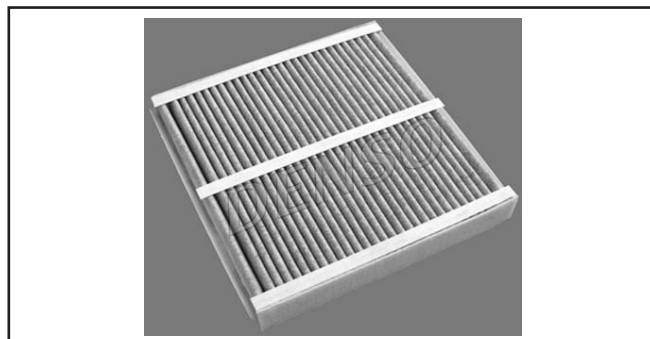

Cabin Air Filter

Photo Guide

DCF423P

Length: 206mm Width: 100mm Height: 37mm

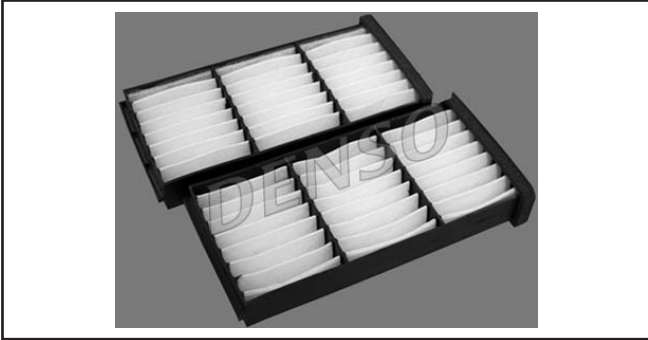

DCF450K

Length: 832mm Width: 122mm Height: 20mm

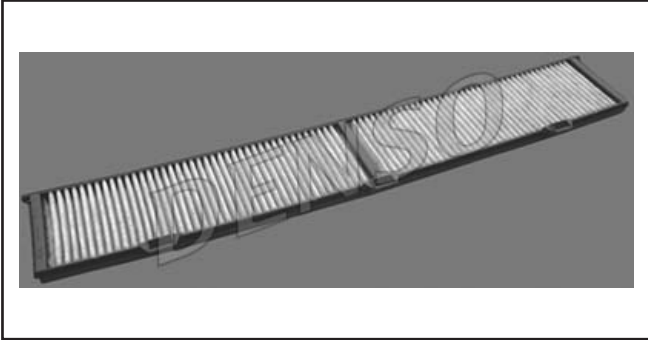

DCF446P

Length: 193mm Width: 180mm Height: 25mm



DCF452P

Length: 394mm Width: 182mm Height: 32mm



DCF448K

Length: 214mm Width: 200mm Height: 28mm



DCF453K

Length: 394mm Width: 182mm Height: 32mm

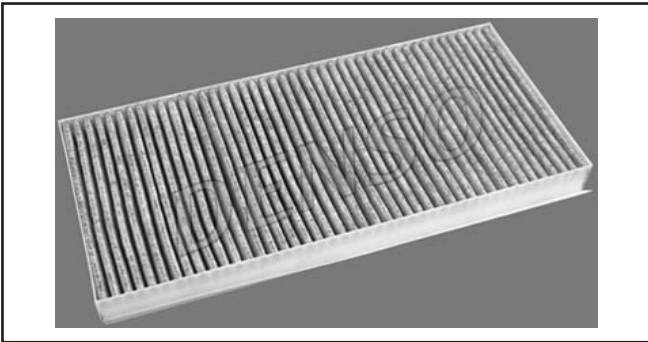

DCF449P

Length: 269mm Width: 207mm Height: 57mm

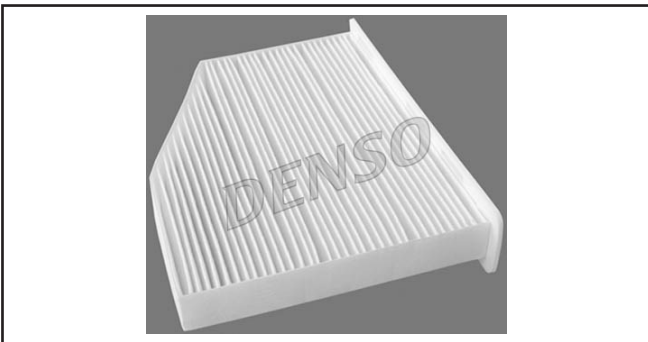

DCF454P

Length: 250mm Width: 235mm Height: 25mm

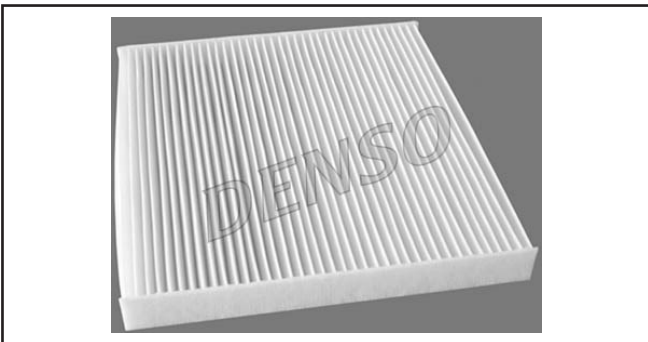

Cabin Air Filter

Photo Guide

DCF457K

Length: 120mm Width: 218mm Height: 25mm

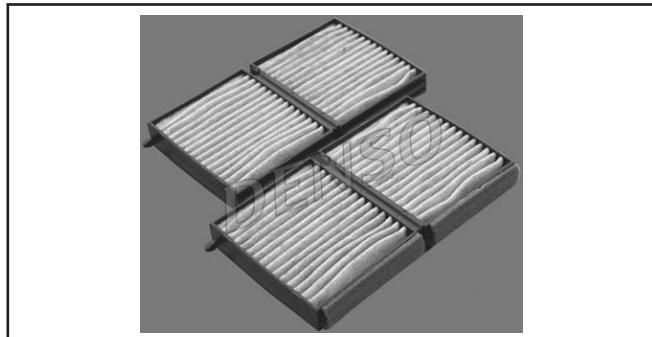

DCF461P

Length: 280mm Width: 205mm Height: 25mm

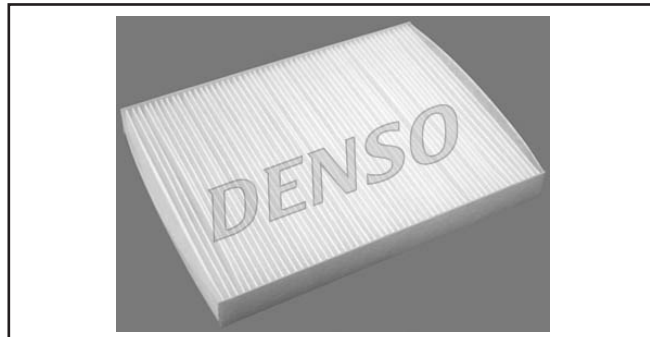

DCF458K

Length: 292mm Width: 225mm Height: 20mm

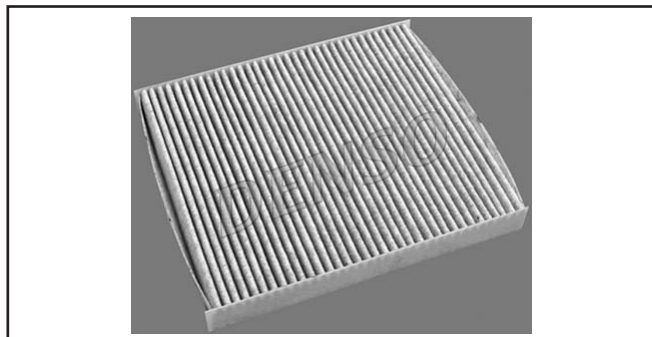

DCF462P

Length: 246mm Width: 216mm Height: 30mm

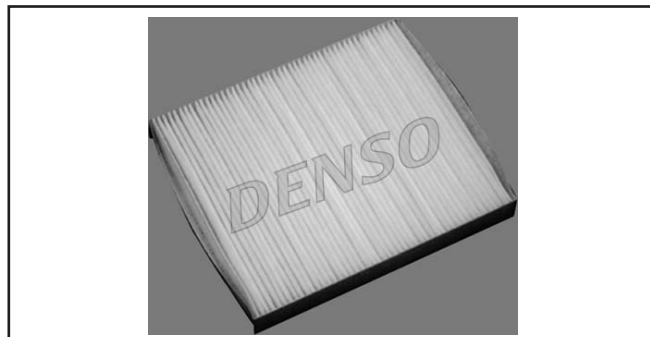

DCF460K

Length: 349mm Width: 170mm Height: 31mm

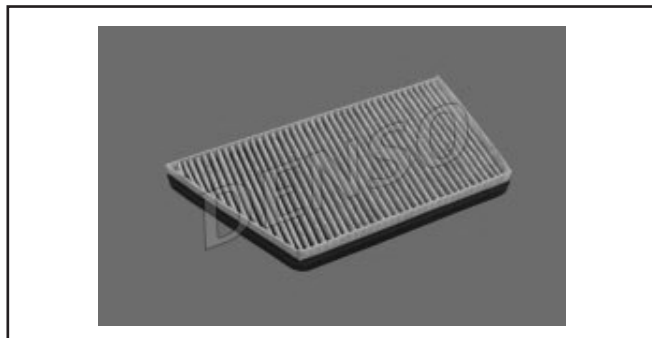

DCF463P

Length: 297mm Width: 205mm Height: 31mm

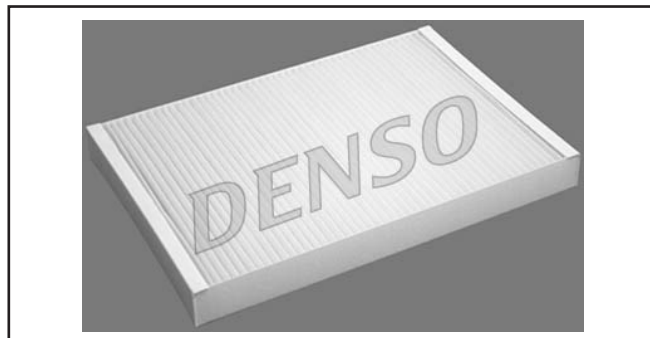

DCF460P

Length: 199mm Width: 142mm Height: 30mm

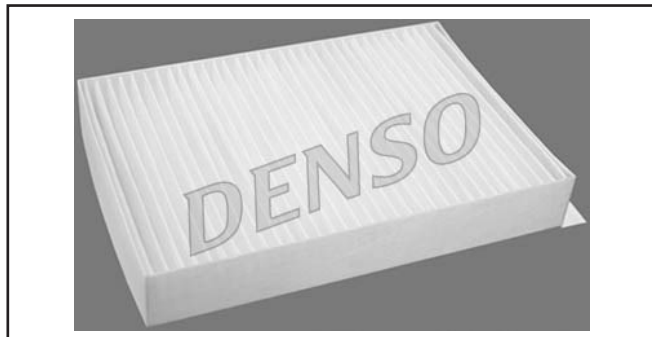

DCF465P

Length: 234mm Width: 209mm Height: 36mm

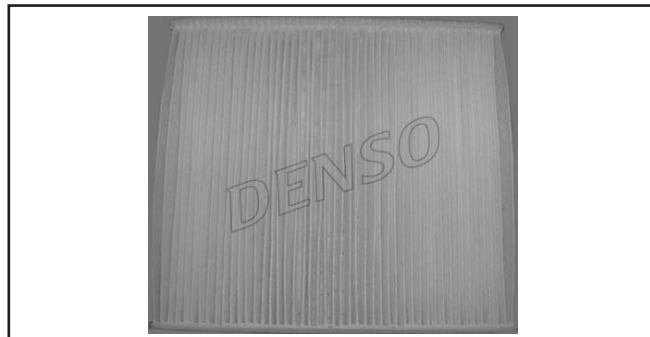

Cabin Air Filter

Photo Guide

DCF466P

Length: 184mm Width: 180mm Height: 30mm

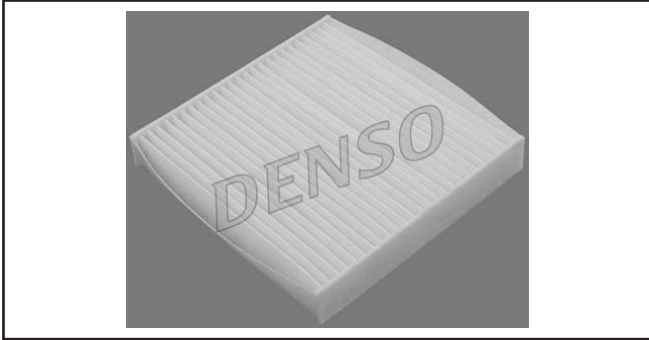

DCF471P

Length: 293mm Width: 208mm Height: 34mm

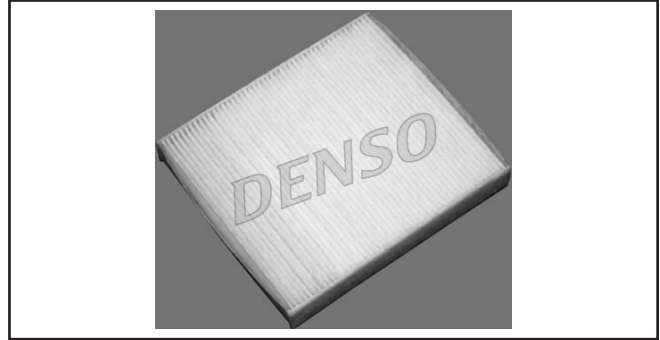

DCF467P

Length: 215mm Width: 200mm Height: 30mm

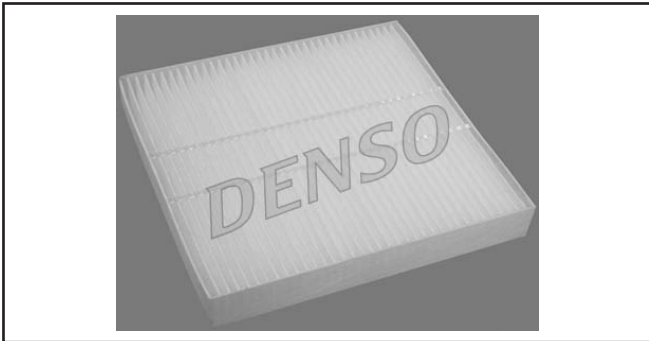

DCF473P

Length: 240mm Width: 197mm Height: 30mm

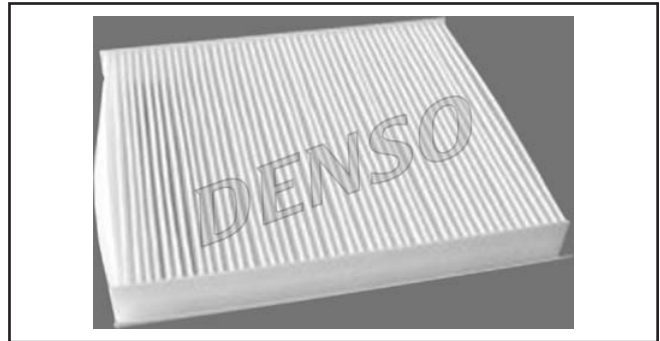

DCF469P

Length: 219mm Width: 200mm Height: 20mm

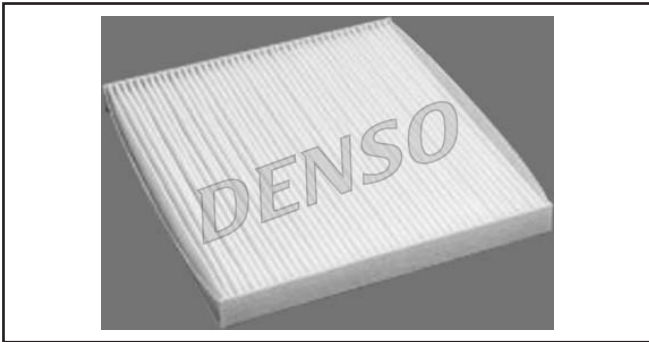

DCF474P

Length: 350mm Width: 160mm Height: 30mm

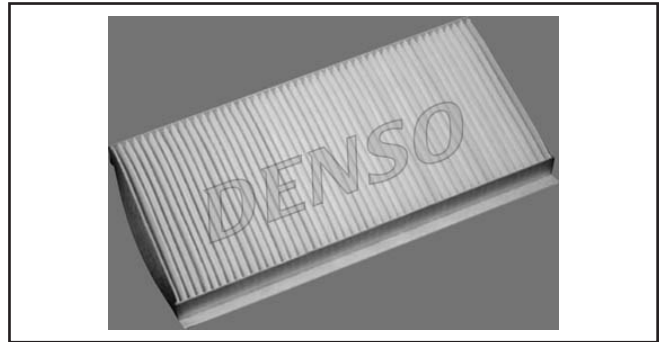

DCF470P

Length: 288mm Width: 175mm Height: 36mm

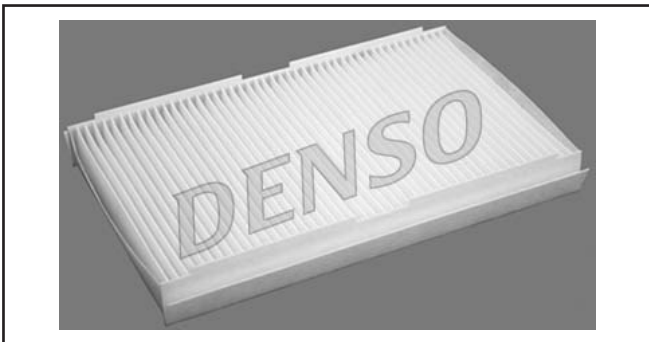

DCF475P

Length: 541mm Width: 256mm Height: 30mm

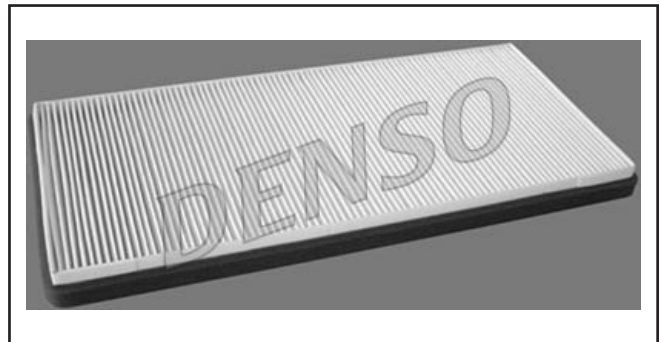

Cabin Air Filter

Photo Guide

DCF476P

Length: 402mm Width: 167mm Height: 33mm

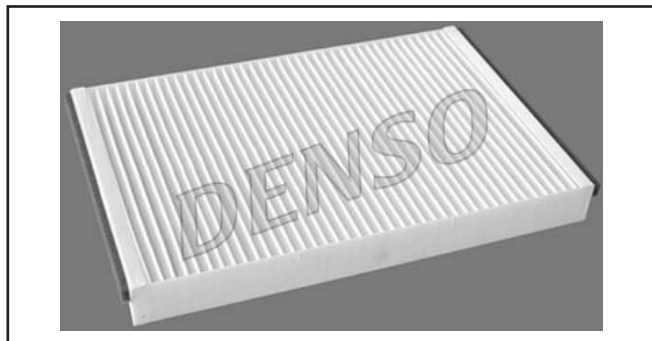

DCF480P

Length: 195mm Width: 215mm Height: 25mm



DCF477P

Length: 277mm Width: 216mm Height: 34mm

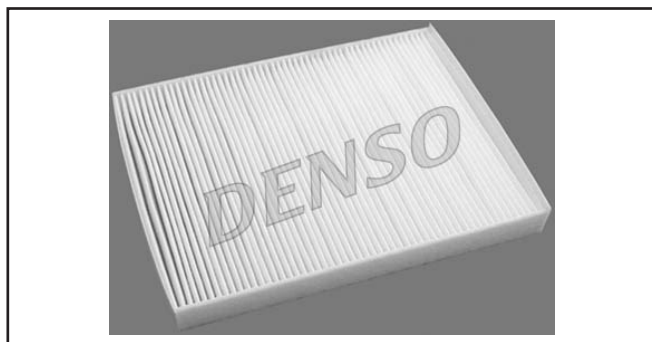

DCF481P

Length: 329mm Width: 164mm Height: 30mm

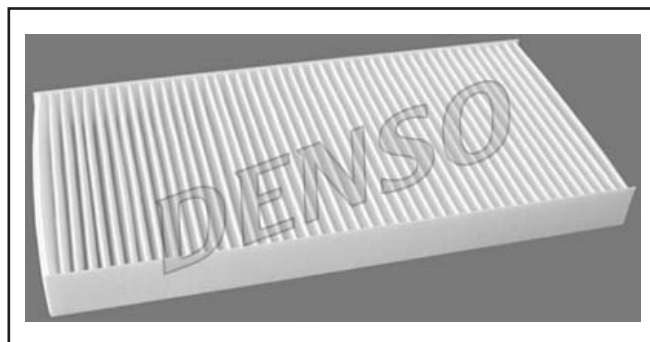

DCF478P

Length: 240mm Width: 189mm Height: 34mm

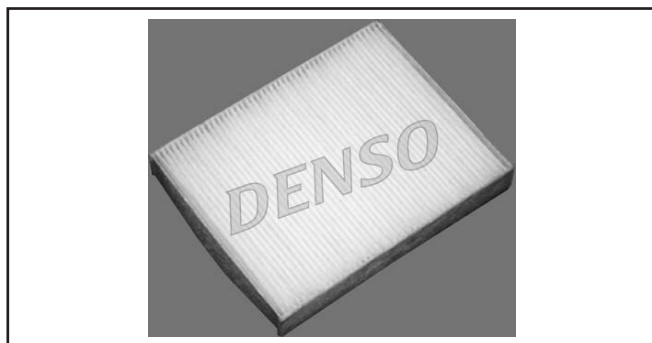

DCF482P

Length: 255mm Width: 229mm Height: 30mm

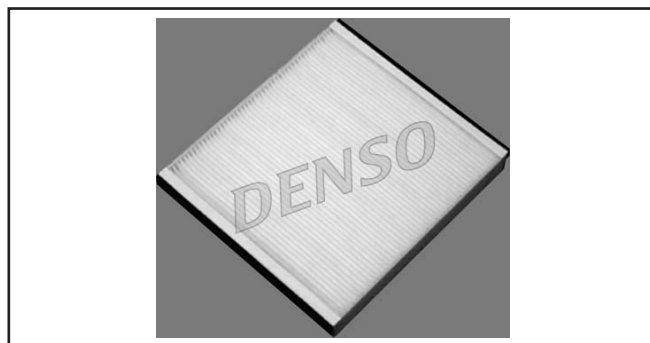

DCF479P

Length: 290mm Width: 96mm Height: 30mm

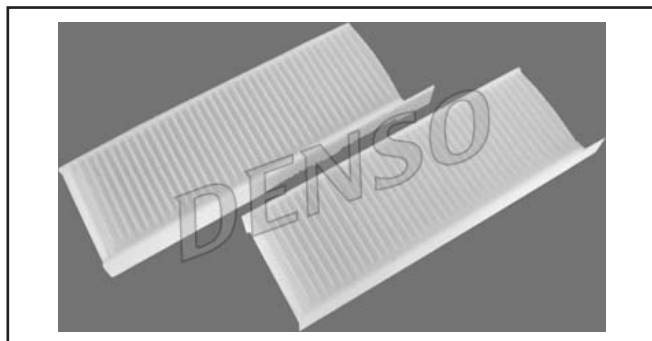

DCF483P

Length: 265mm Width: 195mm Height: 25mm

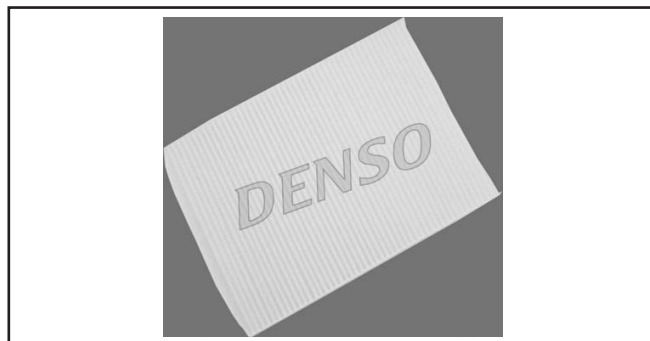

Cabin Air Filter

Photo Guide

DCF485P

Length: 200mm Width: 177mm Height: 30mm

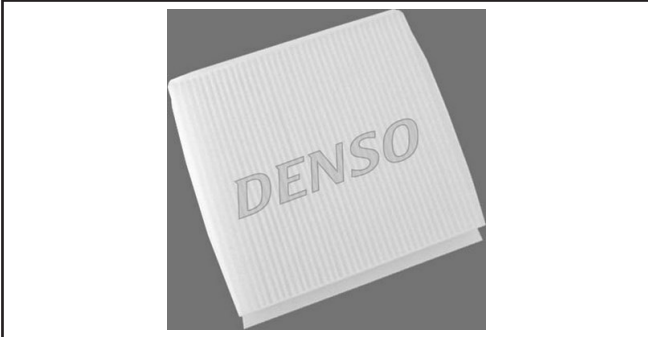

DCF492P

Length: 220mm Width: 215mm Height: 35mm

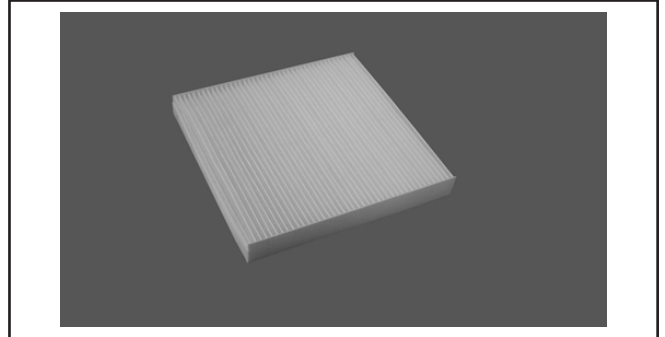

DCF486P

Length: 245mm Width: 215mm Height: 23mm



DCF493P

Length: 350mm Width: 175mm Height: 42mm

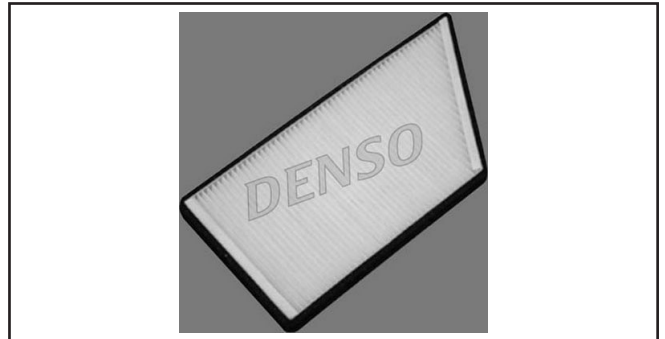

DCF488P

Length: 217mm Width: 265mm Height: 21mm

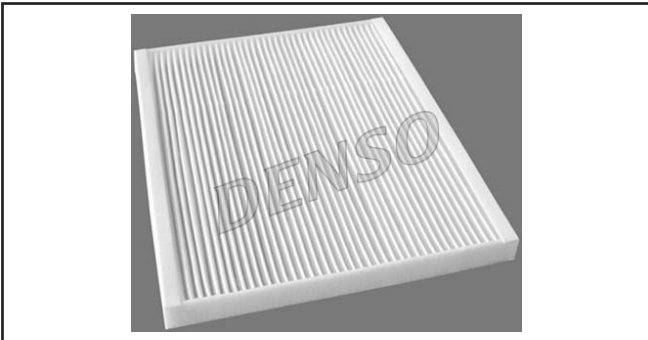

DCF494P

Length: 320mm Width: 272mm Height: 38mm



DCF489P

Length: 238mm Width: 188mm Height: 22mm

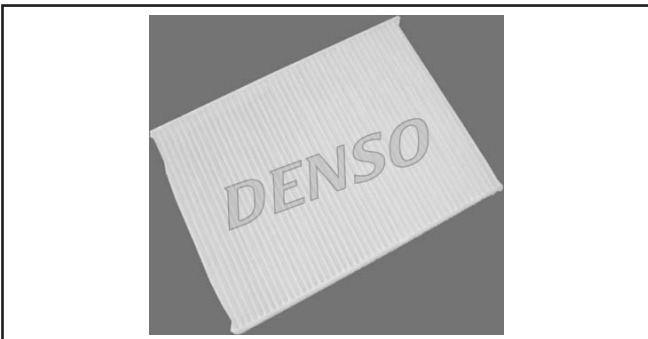

DCF495P

Length: 352mm Width: 244mm Height: 30mm

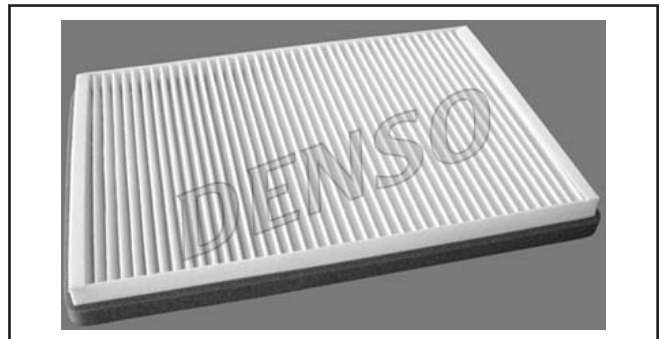

Cabin Air Filter

Photo Guide

DCF497P

Length: 230mm Width: 180mm Height: 21mm

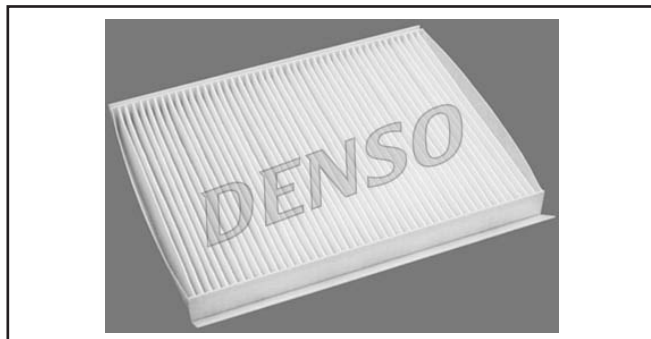

DCF504P

Length: 215mm Width: 162mm Height: 25mm

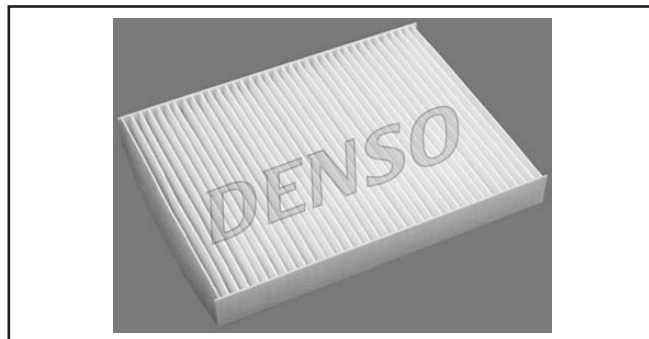

DCF499P

Length: 204mm Width: 177mm Height: 18mm

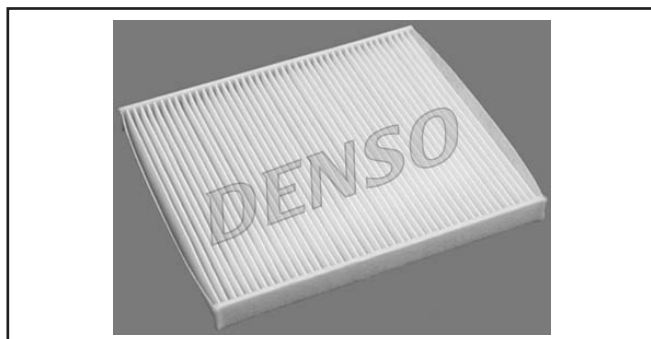

DCF506P

Length: 225mm Width: 210mm Height: 45mm

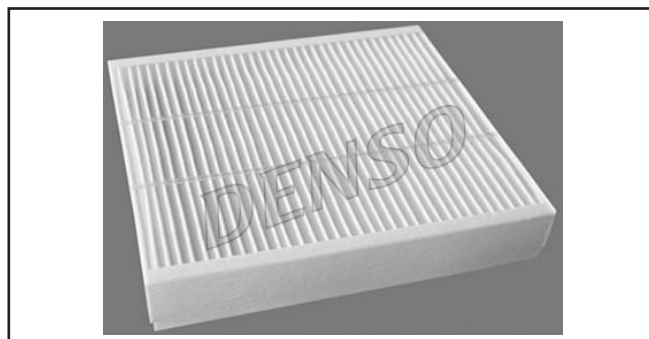

DCF500P

Length: 560mm Width: 120mm Height: 30mm



DCF507P

Length: 288mm Width: 160mm Height: 30mm

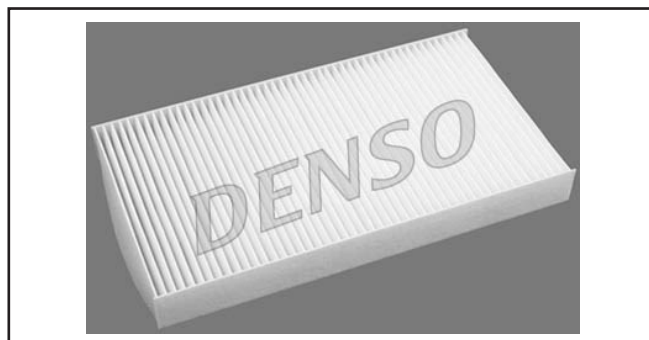

DCF502P

Length: 230mm Width: 160mm Height: 30mm

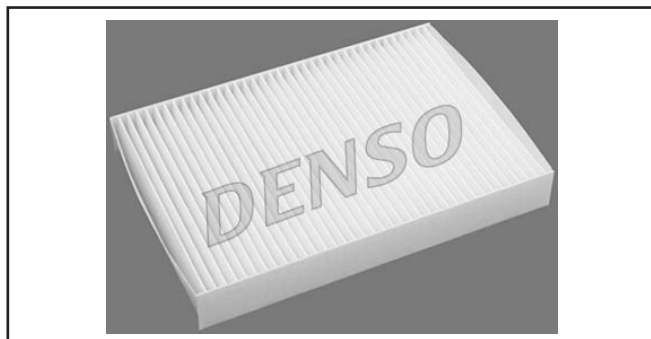

DCF508P

Length: 390mm Width: 150mm Height: 26mm

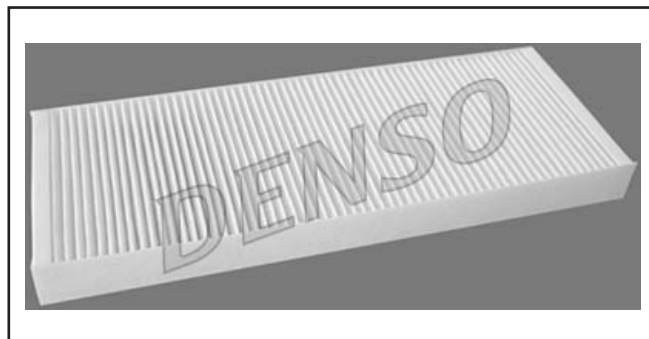

Cabin Air Filter

Photo Guide

DCF509P

Length: 265mm Width: 190mm Height: 20mm



DCF513P

Length: 255mm Width: 199mm Height: 30mm

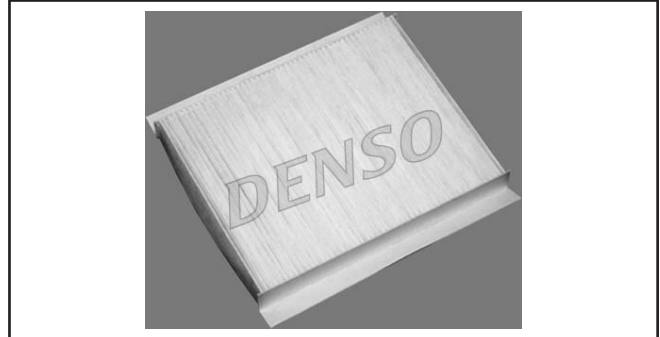

DCF510P

Length: 240mm Width: 210mm Height: 30mm



DCF514P

Length: 273mm Width: 130mm Height: 67mm

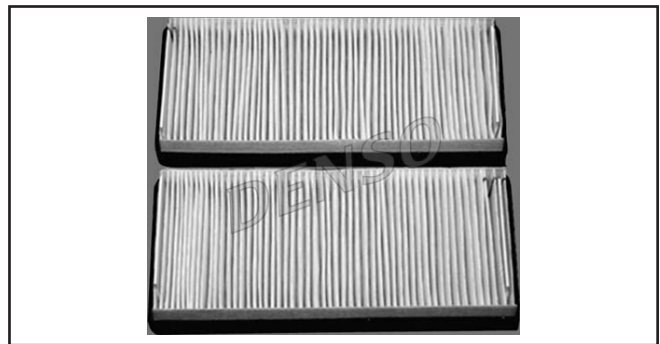

DCF511P

Length: 360mm Width: 234mm Height: 35mm

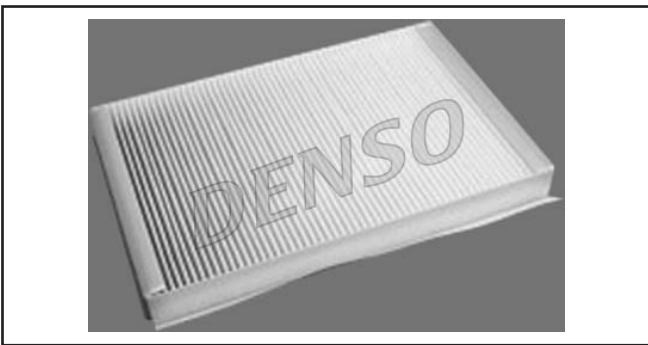

DCF516P

Length: 335mm Width: 175mm Height: 36mm

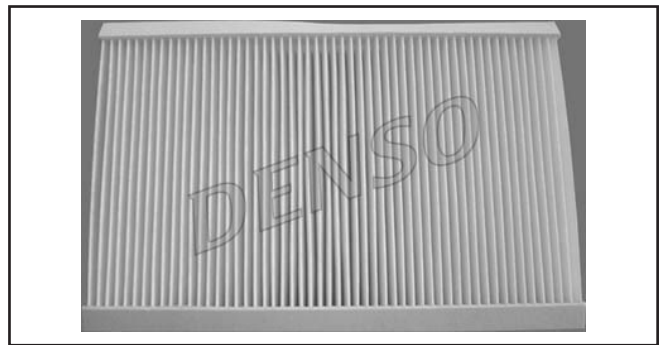

DCF512P

Length: 273mm Width: 130mm Height: 67mm

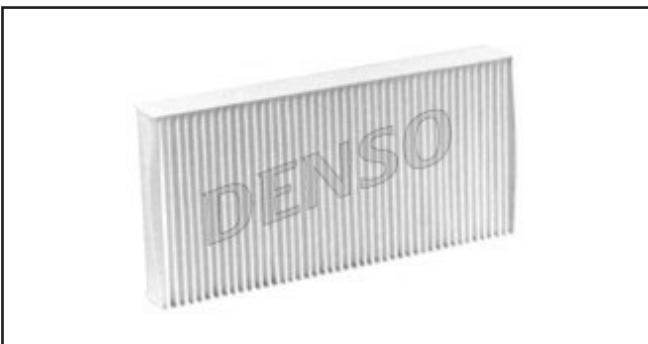

DCF517P

Length: 510mm Width: 97mm Height: 34mm



Cabin Air Filter

Photo Guide

DCF521P

Length: 347mm Width: 208mm Height: 32mm

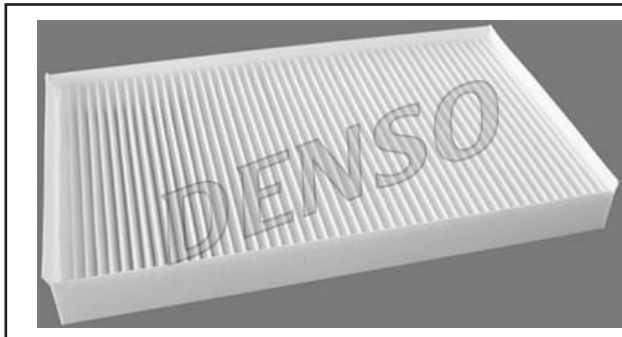

DCF532P

Length: 442mm Width: 168mm Height: 35mm

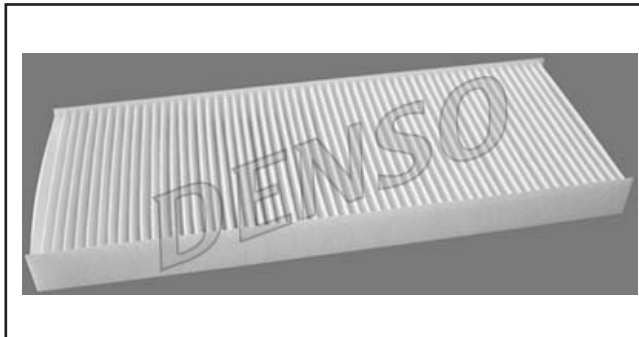

DCF522P

Length: 340mm Width: 106mm Height: 74mm

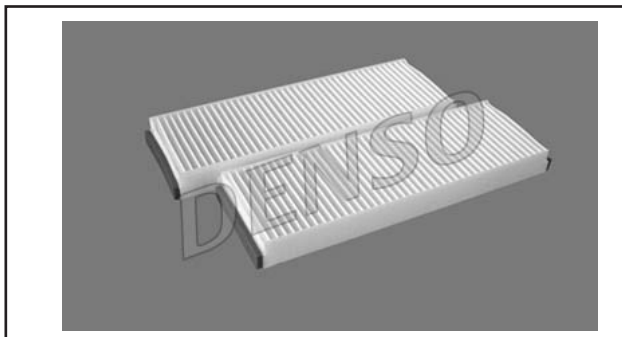

DCF536P

Length: 450mm Width: 165mm Height: 22mm

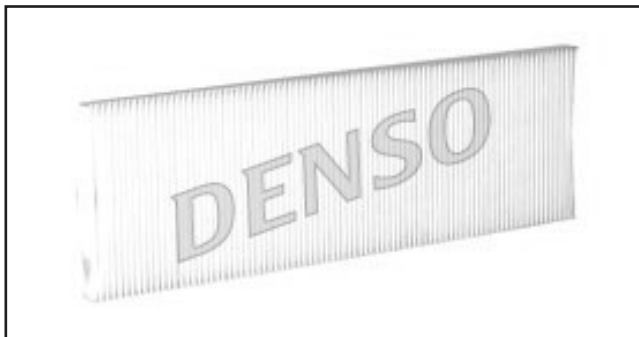

DCF523P

Length: 509mm Width: 110mm Height: 30mm

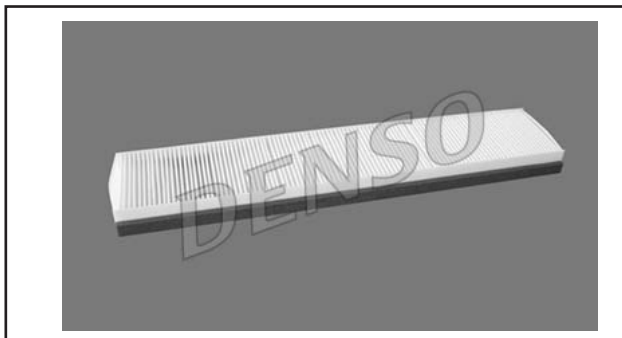

DCF537P

Length: 402mm Width: 167mm Height: 33mm

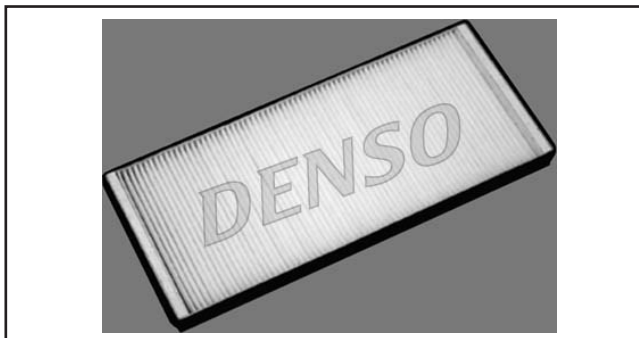

DCF526P

Length: 250mm Width: 206mm Height: 20mm



DCF540P

Length: 260mm Width: 225mm Height: 45mm

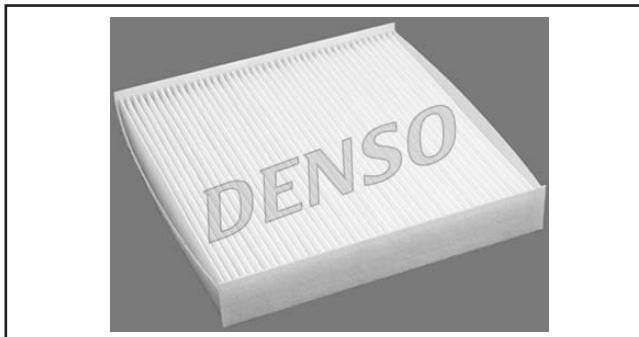

Cabin Air Filter

Photo Guide

DCF541P

Length: 442mm Width: 168mm Height: 35mm

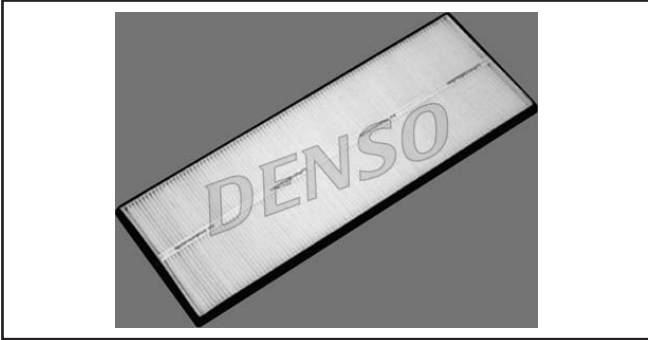

DCF562P

Length: 214mm Width: 150mm Height: 44mm



DCF550P

Length: 245mm Width: 228mm Height: 63mm

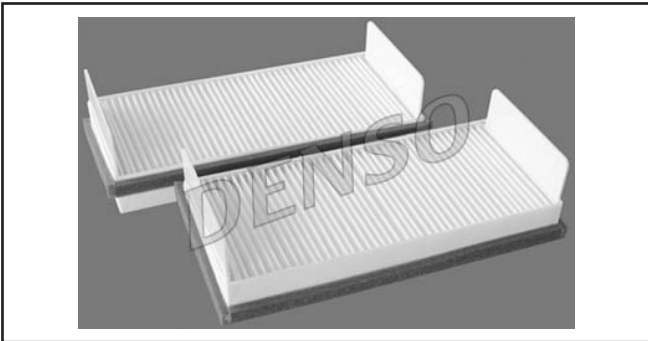

DCF563P

Length: 236mm Width: 96mm Height: 22mm



DCF560P

Length: 203mm Width: 156mm Height: 30mm

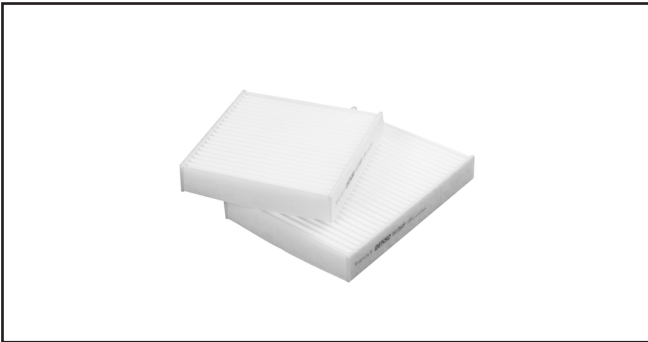

DCF564P

Length: 240mm Width: 204mm Height: 35mm

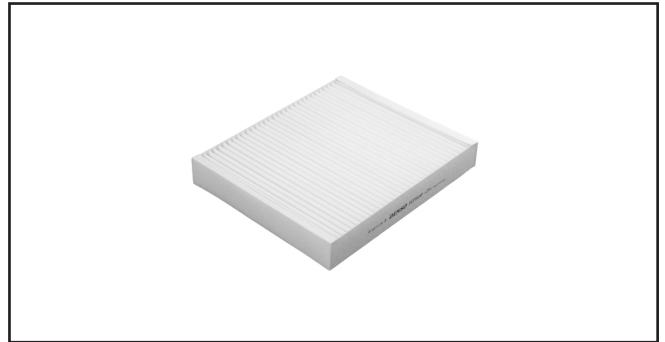

DCF561P

Length: 225mm Width: 234mm Height: 30mm



DCF565P

Length: 238mm Width: 153mm Height: 34mm



Cabin Air Filter

Photo Guide

DCF566P

Length: 274mm Width: 195mm Height: 30mm



DCF570P

Length: 288mm Width: 80mm Height: 18mm



DCF567P

Length: 449mm Width: 118mm Height: 31mm



DCF571P

Length: 241mm Width: 279mm Height: 35mm



DCF568P

Length: 240mm Width: 108mm Height: 20mm



DCF572P

Length: 229mm Width: 200mm Height: 25mm



DCF569P

Length: 230mm Width: 180mm Height: 20mm



DCF573P

Length: 204mm Width: 210mm Height: 30mm



Cabin Air Filter

Photo Guide

DCF574P

Length: 210mm Width: 226mm Height: 20mm

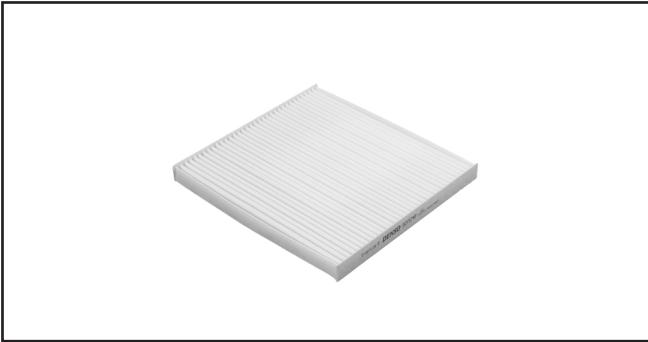

DCF578P

Length: 223mm Width: 196mm Height: 34mm



DCF575P

Length: 254mm Width: 235mm Height: 30mm



DCF579P

Length: 200mm Width: 213mm Height: 34mm



DCF576P

Length: 256mm Width: 224mm Height: 36mm



DCF580P

Length: 195mm Width: 187mm Height: 30mm



DCF577P

Length: 244mm Width: 204mm Height: 20mm



DCF581P

Length: 248mm Width: 198mm Height: 40mm



Cabin Air Filter | Photo Guide

DCF582P

Length: 192mm Width: 238mm Height: 20mm



DCF586P

Length: 260mm Width: 194mm Height: 38mm



DCF583P

Length: 255mm Width: 182mm Height: 35mm



DCF587P

Length: 248mm Width: 188mm Height: 35mm



DCF584P

Length: 220mm Width: 156mm Height: 30mm



DCF588P

Length: 180mm Width: 249mm Height: 36mm



DCF585P

Length: 195mm Width: 145mm Height: 30mm



DCF589P

Length: 215mm Width: 200mm Height: 30mm



Cabin Air Filter

Photo Guide

DCF590P



Length: 212mm

Width: 191mm

Height: 30mm



Cabin Air Filter | Abbreviations

	GB	DE	FR	ES	IT	SE	PL	RU
	Vehicle: Make, Model	Fahrzeug: Fabrikat, Modell	Véhicule: Marque, modèle	Vehículo: marca, modelo	Veicolo: marca e modello	Fordon: Märke, modell	Pojazd: marka, model	Автомобиль: марка, модель,
	Additional information	Zusätzliche Information	Informations complémentaires	Información adicional	Informazioni aggiuntive	Ytterligare information	Informacje dodatkowe	Дополнительная информация
LHD	Left Hand Drive	Linkssteuerung	Commande à gauche	Volante a la izquierda	Guida a sinistra	Vänsterstyrd	Lewostronny układ kierowniczy	Левый привод
RHD	Right Hand Drive	Rechtssteuerung	Commande à droite	Volante a la derecha	Guida a destra	Högerstyrd	Prawostronny układ kierowniczy	Правый привод
	Year (from - to)	Jahr (von - bis)	Année (de - à)	Año (de - a)	Anno (dal- al)	Årsmodell (från - till)	Rok (od - do)	Год (с – по)
P/N	DENSO Partnumber	DENSO-Teilenummer	Code d'article DENSO	Nº de pieza DENSO	Codice DENSO	DENSO artikelnummer	Nr katalogowy DENSO	Номер компонента DENSO
Filter Type P	Particle Filters	Partikelfilter	Filtre à particules	Filtros de partículas	Filtri Particellari	Partikelfilter	Filtry standardowe	Фильтры частиц
Filter Type K	Combination Filters	Kombinationsfilter	Combinaison de filtres	Filtros combinados	Filtri Combinati	Kombinationsfilter	Filtry z węglem aktywnym	Комбинированные фильтры

DENSO Europe
Hogesweyselaan 165
1382 JL Weesp
The Netherlands

Tel: +31 (0)294 493 493
Fax: +31 (0)294 417 122

www.denso-am.eu