

DENSO

Starters & Alternators

| 2021

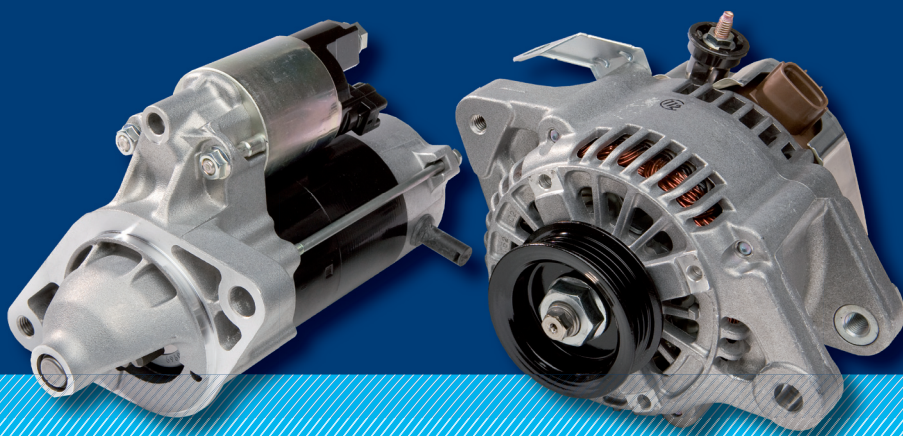

Driven by
Quality

DENSO

A/C Components



DEAC

Driven by Quality

DENSO

Cabin Air Filter



DECF

Driven by Quality

DENSO

Diesel Fuel Filter



DEDF

Driven by Quality

DENSO

Engine Cooling

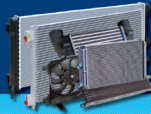

DEEC

Driven by Quality

DENSO

Lambda Sensors



DELS

Driven by Quality

DENSO

Spark Plugs | Motorcycle/Small Engine/Marine



DEMC

Driven by Quality

DENSO

Engine Management Systems



DEMS

Driven by Quality

DENSO

Starters & Alternators



DESA

www.denso-am.au

Driven by Quality

DENSO

Spark Plugs & Glow Plugs



DESG

Driven by Quality

60th ANNIVERSARY 1954-2014

DENSO

Wiper Blades | Right Hand Drive | Left Hand Drive



DEWB

Driven by Quality

Starters & Alternators

Table of Contents

GB**Table of Contents**

4	Introduction & Range
5	Characteristics
20	Abbreviations
23	Application Tables - Starters
87	Application Tables - Alternators
145	Photo Guide
283	Cross Reference Chart

D**Inhaltsverzeichnis**

6	Einleitung & Angebot
7	Eigenschaften
20	Abkürzungen
23	Anwendungstabellen - Anlasser
87	Anwendungstabellen - Lichtmaschinen
145	Fotoanweisung
283	Querverweistabellen

F**Table des matières**

16	Introduction & Gamme
17	Caractéristiques
20	Abréviations
23	Tableau d'affectations - Démarreurs
87	Tableau d'affectations - Alternateurs
145	Guide photographique
283	Tableau de correspondances

E**Índice**

14	Introducción & Gama
15	Características
20	Símbolos y abreviaturas
23	Tabla de Aplicaciones - Motores de Arranque
87	Tabla de Aplicaciones - Alternadores
145	Guía de fotografías
283	Referencias Cruzadas

I**Indice**

12	Introduzione & Gamma
13	Caratteristiche
20	Abbreviazioni
23	Tabelle d'applicazioni - Motorini d'avviamento
87	Tabelle d'applicazioni - Alternatori
145	Guide fotografica
283	Tabella di riferimento

SE**Innehåll**

18	Inledning & Utbud
19	Tekniska specifikationer
20	Förkortningar
23	Tillämpningar - Startmotorer
87	Tillämpningar - Generatorer
145	Foton
283	Korsreferens

PL**Spis treści**

8	Wstęp & Oferta
9	Charakterystyka
20	Skróty
23	Tabele zastosowań - Rozruszniki
87	Tabele zastosowań - Alternatory
145	Przewodnik ze zdjęciami
283	Tabela zamienników

RU**Содержание**

10	Введение и ассортимент
11	Характеристики
20	Сокращения
23	Таблица применений для стартеров
87	Таблица применений для генераторов
145	Руководство- фотогид
283	Таблица взаимозаменяемости

GB

The DENSO difference

Advanced design. OE quality manufacture. Powerful performance. These are the exceptional standards behind DENSO's replacement Starters and Alternators – bringing world class rotating machines technology direct to the aftermarket.

One of the world's largest automotive component suppliers, DENSO is a global leader in developing and manufacturing rotating machines. Our unwavering commitment to outstanding quality, design and innovation mean that our Starters and Alternators are selected as original equipment by carmakers worldwide – winning many supplier and international quality awards along the way.

Founded on this expertise, DENSO's programme of replacement Starters and Alternators offers OE specification, completely new parts, with no remanufactured units. Every machine is subjected to our rigorous manufacturing and testing processes, so you can be sure they meet the highest standards of fit and performance. As well as delivering unique, OE coverage of Toyota and a wide range of European marques such as Ford, Opel, BMW, Fiat and Land Rover, the programme is continually being updated and expanding – and is planned to cover more than 900 applications by 2012.

Why DENSO

- > World-class quality: Manufactured to OE specification
- > Advanced technologies: Featuring DENSO's latest OE technologies and OE production modifications
- > No remanufactured units: No core surcharge or return policy
- > Continual expansion: Programme will offer more than 900 applications by 2012
- > Unique applications: Unrivalled Toyota coverage plus wide range of European marques including Ford, Opel, BMW, Fiat, Land Rover
- > Efficiency: Small size and light weight, yet delivering high output

When you need a replacement Starter or Alternator, there's only one name to choose: DENSO.

World-leading technologies

DENSO Starters

Since introducing its first commercial automotive Starters in the early 1960s, DENSO has poured its world-leading engineering expertise into developing smaller, lighter units that can maintain the highest possible output. In 2001, for example, DENSO introduced the world's first Planetary Reduction Segment Conductor Motor (PS) Starter featuring a square conductor in the armature coil. The PS starter was 22 percent lighter and 14 percent shorter than the Reduction A type (RA) Starter, delivering improved fuel efficiency and an easier fit.

Today, DENSO offers two, advanced types of Starter for aftermarket customers:

RA-Starter

- > High-speed motor with an improved deceleration ratio and a heat-resistant electric wire reduces the size and weight of the motor
- > Cold-forged spline reduces the size and weight of the magnetic switch



PS-Starter

- > A rectangular conductor and surface commutator in the armature, together with a magnet between the main electrodes of the yoke, reduces the size and weight of the starter
- > The damper unit combined with a high deceleration ratio further reduces starter size and reduces driving noise

DENSO Alternators

DENSO introduced its first automotive Alternators in the 1960s. Since then we have pioneered a variety of new alternator designs capable of producing more electrical power more efficiently, yet in a smaller, lighter unit. In 2000, for example, DENSO introduced the world's first SC (Segment Conductor) alternator using a rectangular conductor for its stator coil. By raising the winding density (space factor) from 45 percent to 70 percent, we were able to make the SC Alternator 20 percent lighter and achieve 50 percent higher output than a conventional type.

Today, DENSO offers two, advanced types of Alternator for aftermarket customers:

Alternator with Small Internal Fan

- > Optimised stator and rotor sizes improve the magnetic circuit to increase output
- > Smaller pulley diameter allows a faster rotor
- > Fan features two blades, integrated with the rotor, to reduce fan noise, size and weight



SC Alternator

- > The world's first rectangular conductor in the stator coil increases winding density, reduces weight and increases output
- > One chip IC regulator



GB

Technical drawing: Starter

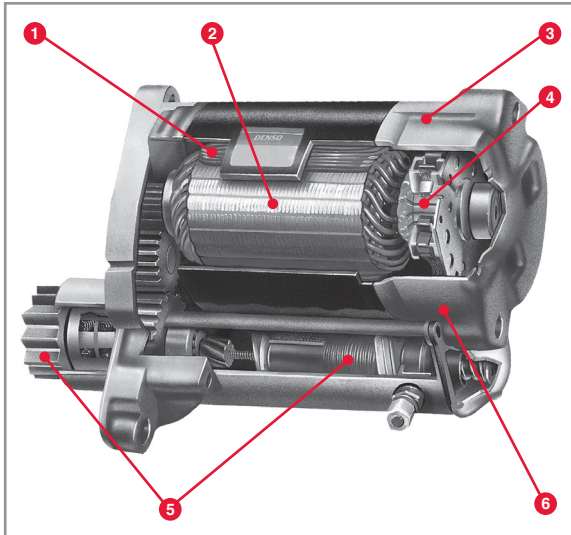

1. Field Coil
2. Armature
3. Housing
4. Commutator
5. Pinion Gear Solenoid Coil
6. Terminal Bolt

Technical drawing: Alternator

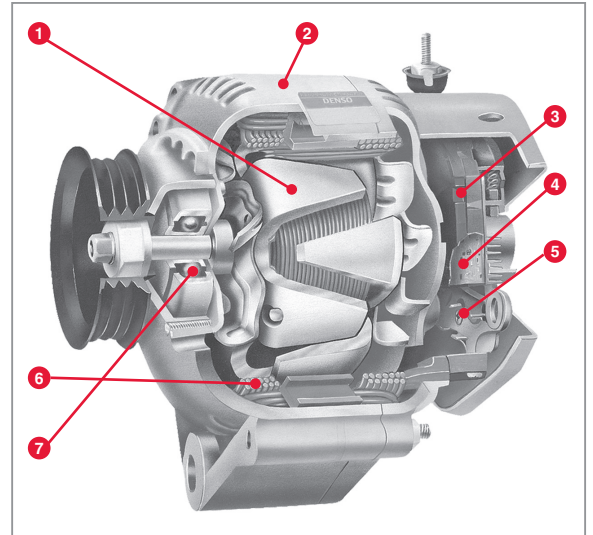

1. Rotor
2. Housing
3. Slipring
4. Voltage Regulator
5. Rectifier
6. Stator
7. Bearing

Der DENSO-Unterschied

Hochentwickeltes Design. Erstausrüsterqualität. Leistungsstarke Technik. Diese außergewöhnlich hohen Maßstäbe bilden die Grundlage für die Anlasser und Lichtmaschinen aus dem Ersatzteilprogramm von DENSO – und bringen dadurch Generatoren- und Startertechnik von Weltklasse direkt in den Aftermarket-Bereich.

Als einer der größten Hersteller von Kfz-Bauteilen der Welt ist DENSO ein weltweit führender Entwickler und Hersteller von Drehfeldmaschinen. Das unerschütterliche Engagement des Unternehmens für überragende Qualität, beste Konstruktion und ausgezeichnete Innovation bedeutet, dass seine Anlasser und Lichtmaschinen von Autoherstellern weltweit als Erstausrüstung gewählt werden und immer wieder begehrte Hersteller- und internationale Qualitätsauszeichnungen erhalten.

Gestützt auf diese Fachkenntnis und Kompetenz bietet das DENSO-Ersatzteilprogramm Anlasser & Lichtmaschinen ausschließlich Neuteile in Erstausrüsterqualität, keine überholten Geräte. Jedes Gerät muss die strengen Herstellungs- und Prüfverfahren von DENSO bestehen. Sie können daher sicher sein, dass es den höchsten Eignungs- und Leistungsmaßstäben gerecht wird. Das Sortiment liefert nicht nur die einzigartige Erstausrüster-Abdeckung von Toyota und Geräte für eine breit gefächerte Palette europäischer Marken wie Ford, Opel, BMW, Fiat und Land Rover, sondern wird auch kontinuierlich aktualisiert und erweitert – das gegenwärtige Angebot soll bis 2012 auf mehr als 900 Anwendungen vergrößert werden.

Warum Sie sich für Anlasser und Lichtmaschinen von DENSO entscheiden sollten

- > Weltklasse-Qualität: Hergestellt nach Erstausrüstervorgaben
- > Hochentwickelte Technik: Mit den neuesten Erstausrüster-Technologien und OE-Produktionsänderungen
- > Keine überholten Geräte und kein Pfandzuschlag
- > Kontinuierliche Erweiterung: 2012 soll das Sortiment mehr als 900 Anwendungen abdecken
- > Einzigartige Anwendungen: Unübertroffene Abdeckung von Toyota und eine breit gefächerte Palette europäischer Marken, einschl. Ford, Opel, BMW, Fiat, Land Rover
- > Effizienz: Kompakte Größe und leichtes Gewicht bei hoher Ausgangsleistung

Für Ersatz-Anlasser und -Lichtmaschinen gibt es deshalb eigentlich nur eine Wahl: DENSO



Weltweit führende Technologien

DENSO-Anlasser

Seit der Einführung seiner ersten kommerziellen Kfz-Anlasser Anfang der 1960er Jahre hat DENSO sein weltweit führendes technisches Knowhow in die Entwicklung kompakterer und leichter Geräte, die fortgesetzt die maximale Leistung erbringen können, einfließen lassen. Beispielsweise stellte DENSO 2001 den ersten SC-Starter (SC – Segment Conductor) mit vorgelegtem Planetengetriebe (PS) der Welt mit einem viereckigen Leitungsquerschnitt für die Ankerwicklung her. Dieser PS-Anlasser war 22 % leichter und 14 % kürzer als der RA-Starter genannte Anlasser mit Vorgelege, war leichter einzubauen und ergab einen besseren Kraftstoffverbrauch.

Heute bietet DENSO zwei hochentwickelte Anlassertypen für den Aftermarket an:

Anlasser mit Vorgelege (RA-Starter)

- > Hochtouriger Motor mit einem verbessertem Bremsverhältnis, wärmebeständiger elektrischer Draht verringert Größe und Gewicht des Motors
- > Kleinerer und leichter Magnetschalter dank kaltgeschmiedeter Keilverbindung



SC-Anlasser mit vorgelegtem Planetengetriebe (PS-Starter)

- > Ein Leiter mit rechteckigem Querschnitt und ein Oberflächenkollektor im Anker sowie ein Magnet zwischen den Hauptelektroden des Polgehäuses ergeben einen kleineren und leichteren Anlasser
- > In Verbindung mit einem hohen Bremsverhältnis verringert die Dämpfungseinheit die Anlassergröße weiter und führt zu geringeren Fahrgeräuschen

DENSO-Lichtmaschinen

DENSO stellte seine ersten Kfz-Lichtmaschinen in den 1960er Jahren vor. Seit damals hat das Unternehmen bahnbrechend verschiedene neue Lichtmaschinenversionen entwickelt, die in kompakterer, leichter Ausführung effizienter mehr Elektrizität erzeugen können. Beispielsweise stellte DENSO 2000 die erste SC-Lichtmaschine (SC – Segment Conductor) mit rechteckigem Leiterquerschnitt für die Ständerwicklung vor. Durch eine Steigerung der Wicklungsdichte von 45 % auf 70 % konnte die SC-Lichtmaschine 20 % leichter gemacht werden und 50 % leistungstärker als konventionelle Lichtmaschinen.

Heute bietet DENSO zwei hochentwickelte Lichtmaschinentypen für den Aftermarket an:

Lichtmaschine mit kleinem Ventilator

- > Optimierte Rotor- und Statorgrößen verbessern den magnetischen Schaltkreis und steigern dadurch die Leistung
- > Kleinere Riemenscheibe ermöglicht schnelleren Rotor
- > Ruhigere, kleinere und leichtere Lichtmaschine dank Ventilator mit zwei Flügeln, in Rotor integriert



SC-Lichtmaschine

- > Weltweit erstmals: Der rechteckige Leiterquerschnitt der Ständerwicklung erhöht die Wicklungsdichte, verringert das Gewicht und steigert die Leistung
- > IC-Regler (nur ein Chip)

D

Technische Zeichnung: Anlasser

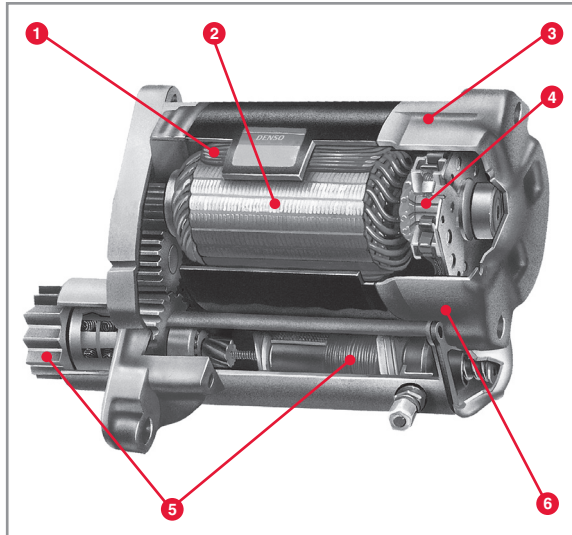

1. Feldwicklung
2. Anker
3. Gehäuse
4. Kollektor
5. Ritzel-Magnetwicklung
6. Anschlussschraube

Technische Zeichnung: Lichtmaschine

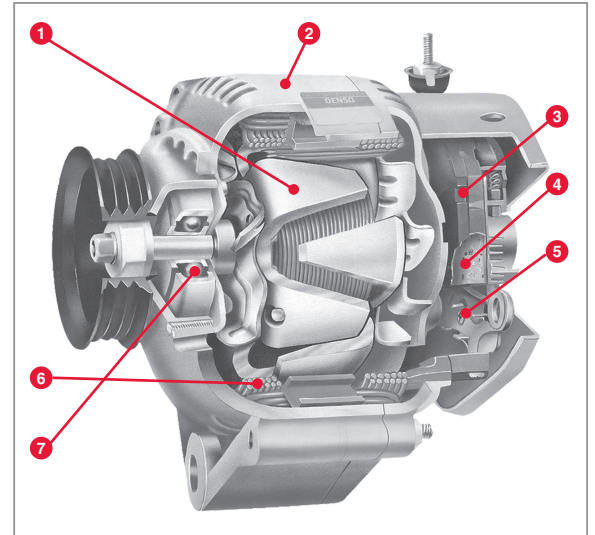

1. Rotor
2. Gehäuse
3. Schleifring
4. Spannungsregler
5. Gleichrichter
6. Stator
7. Lager

PL

Różnica DENSO

Zaawansowana konstrukcja. Produkcja o jakości OE. Potężne osiągi. Są to wyjątkowe standardy, które stoją za zamiennymi rozrusznikami i alternatorami firmy DENSO – wprowadzając światowej klasy technologię urządzeń obrotowych na rynek wtórny.

Firma DENSO, jeden z największych producentów części dla przemysłu motoryzacyjnego, jest światowym liderem w dziedzinie rozwoju i produkcji urządzeń obrotowych. Niezachwiane zaangażowanie firmy w wyjątkową jakość, konstrukcję i innowacje sprawiło, że nasze rozruszniki i alternatory zostały wybrane jako wyposażenie oryginalne przez producentów samochodów na całym świecie – otrzymując w międzyczasie wiele międzynarodowych nagród od dostawców.

W oparciu o te kompetencje, program wymiany rozruszników i alternatorów DENSO oferuje specyfikacje OE i całkowicie nowe części, bez modułów regenerowanych. Każde urządzenie podlega naszym surowym procedurom produkcyjnym i testowym, więc możemy Państwa zapewnić, że spełniają one najwyższe wymagania w zakresie montażu i osiągnięć. Obok unikatowych dostaw OE dla firmy Toyota i szerokiej gamy marek europejskich, takich jak Ford, Opel, BMW, Fiat i Land Rover, program jest na bieżąco aktualizowany i rozszerzany. Do 2012 roku planujemy objąć nim ponad 900 zastosowań.

Dlaczego DENSO?

- > Światowa jakość: Produkcja zgodna ze specyfikacjami OE
- > Zaawansowane technologie: Wykorzystanie przez DENSO najnowszych technologii OE i modyfikacja produkcji OE
- > Brak modułów regenerowanych: Polityka braku kaucji recyklingowej
- > Ciągły rozwój: Do 2012 roku programem objęte zostanie ponad 900 zastosowań
- > Unikatowe zastosowania: Niezrównany zakres zastosowań dla Toyoty oraz szerokiej gamy marek europejskich, takich jak Ford, Opel, BMW, Fiat, Land Rover
- > Wydajność: Niewielkie wymiary i masa przy wysokiej wydajności

Dlatego, gdy konieczna jest wymiana rozrusznika lub alternatora, wybór jest tylko jeden: DENSO.



Przodujące w świecie technologii

Rozruszniki DENSO

Od chwili wprowadzenia na rynek swych pierwszych rozruszników samochodowych na początku lat 60-tych ubiegłego wieku, DENSO wykorzystywało swą przodującą w świecie biegłość inżynierską przy opracowywaniu mniejszych, lżejszych jednostek, które jednocześnie mogłyby utrzymać możliwie najwyższe osiągi. Przykładowo, w 2001 roku firma DENSO, jako pierwsza na świecie, wprowadziła rozrusznik wyposażony w przekładnię planetarną i uzwojenie wirnika wykonane z drutu o przekroju prostokątnym (rozrusznik PS). Rozrusznik PS był o 22 procent lżejszy i 14 procent krótszy niż rozrusznik z reduktorem typu A (RA), jednocześnie zapewniając mniejsze zużycie paliwa i łatwiejszy montaż.

Obecnie DENSO oferuje klientom rynku wtórnego dwa nowoczesne typy rozruszników:

Rozrusznik RA

- > Wysokoobrotowy silnik z poprawionym współczynnikiem hamowania i przewodami o wysokiej odporności termicznej, które zmniejszają wymiary i masę silnika
- > Kuty na zimno wielowypust zmniejsza wymiary i masę przełącznika magnetycznego



Rozrusznik PS

- > Zastosowanie drutu o przekroju prostokątnym i płaskiego komutatora w wirniku razem z magnesem miedzy głównymi elektrodami jarzma, zmniejsza wymiary i masę rozrusznika
- > Moduł tłumiący w połączeniu z wysokim współczynnikiem hamowania dodatkowo zmniejsza wymiary rozrusznika oraz hałas podczas pracy

Alternatory DENSO

Firma DENSO wprowadziła swe pierwsze alternatory samochodowe na rynek w latach 60-tych ubiegłego wieku. Od tego czasu stworzyliśmy wiele pionierskich konstrukcji alternatorów, które były zdolne do wytwarzania większej mocy elektrycznej, z większą sprawnością oraz w mniejszych i lżejszych urządzeniach. Przykładowo, w 2000 roku firma DENSO, jako pierwsza na świecie, wprowadziła alternator typu SC wykorzystujący w uzwojeniu stojana drut o przekroju prostokątnym. Zwiększając gęstość uzwojenia od 45 do 70 procent, mogliśmy wyprodukować alternator SC, który był o 20 procent lżejszy i posiadał o 50% wyższą moc od alternatora konwencjonalnego.

Obecnie DENSO oferuje klientom rynku wtórnego dwa nowoczesne typy alternatorów:

Alternatory z niewielkim wentylatorem wewnętrznym

- > Zoptymalizowane wymiary stojana i wirnika pozwalają na zwiększenie mocy obrotu magnetycznego
- > Zmniejszona średnica koła pasowego umożliwia zastosowanie szybszego wirnika
- > Wentylator wyposażony w dwie łopatki, zintegrowane z wirnikiem, charakteryzuje się niższym poziomem hałasu, mniejszymi wymiarami i masą



Alternator SC

- > Drut o przekroju prostokątnym w uzwojeniu stojana, zastosowany po raz pierwszy na świecie, zwiększa gęstość uzwojenia, zmniejsza masę i zwiększa moc
- > Regulator w jednym układzie scalonym

PL

Rysunek techniczny Rozrusznik

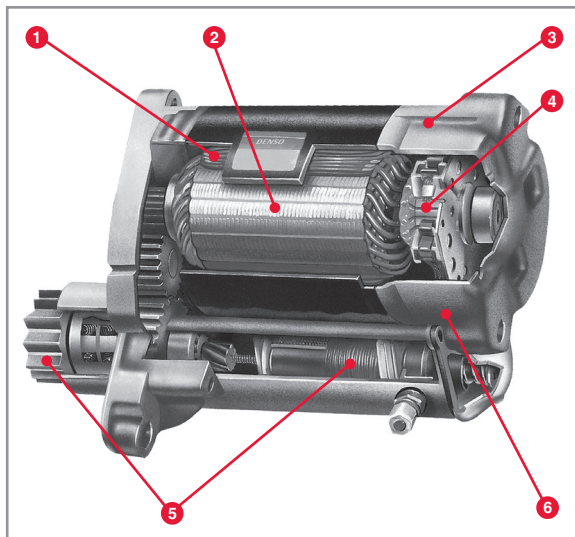

1. Cewka magnetycznej
2. Wirnik
3. Obudowa
4. Komutator
5. Cewka zębniaka
6. Śruba zacisku

Rysunek techniczny Alternator

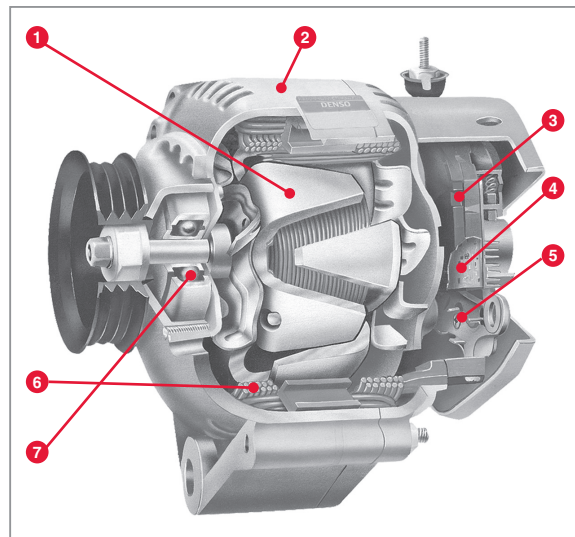

1. Wirnik
2. Obudowa
3. Pierścień ślizgowy
4. Regulator napięcia
5. Prostownik
6. Stożan
7. Łożysko

RU

Отличительные характеристики DENSO

Усовершенствованная конструкция. Качество оригинального оборудования. Высокая эффективность. Именно таких высоких стандартов придерживается компания DENSO при производстве стартеров и генераторов, делая технологии высочайшего уровня доступными на вторичном рынке автокомпонентов.

Компания DENSO, один из крупнейших в мире поставщиков автокомпонентов, является лидером в сфере разработки и производства вращающихся механизмов. Незыблемые принципы, которых мы придерживаемся, – выдающееся качество, инновации и современный дизайн – стали залогом того, что многие автопроизводители выбирают стартеры и генераторы DENSO в качестве оригинального оборудования. Правильность выбора автопроизводителей подтверждается многочисленными наградами, полученными DENSO в качестве лучшего поставщика, а также международными наградами за выдающееся качество продукции, полученными компанией за время ее существования.

Эти принципы положены в основу производственной программы DENSO по стартерам и генераторам оригинального качества для вторичного рынка без использования восстановленных деталей. Строжайший контроль в процессе производства и тщательное тестирование каждого механизма исключают проблемы при установке детали и гарантируют бесперебойную работу. В настоящий момент DENSO предлагает стартеры и генераторы оригинального качества для автомобилей Toyota и ряда европейских марок, таких как Ford, Opel, BMW, Fiat и Land Rover. Программа постоянно обновляется и расширяется – к 2012 году планируется расширение ассортимента до 900 применений.

Почему именно DENSO?

- > Высочайший уровень качества: продукция производится в точном соответствии со спецификацией автопроизводителей; не используются восстановленные детали
- > Передовые технологии: использование самых современных технологий в соответствии с требованиями, предъявляемыми к оригинальным автокомпонентам
- > Постоянное расширение программы: программа будет охватывать более 900 применений к 2012 году
- > Уникальные применения: большое количество применений для Toyota и многих европейских марок, включая Ford, Opel, BMW, Fiat, Land Rover
- > Эффективность: высокая производительность, несмотря на небольшой размер и вес детали

Если в вашем автомобиле необходимо заменить стартер или генератор, есть только одно решение – DENSO.



Ведущие мировые технологии

Стартеры DENSO

С начала 1960-х годов, когда на рынке были представлены первые стартеры DENSO, инженеры компании сосредоточились на разработке и создании малых по размеру и весу механизмов, обладающих при этом высочайшей производительностью. В 2001 году компания DENSO представила первый в мире PS стартер (планетарный редукторный стартер с сегментным проводником), провод обмотки которого имеет квадратное сечение. Вес и размер PS стартера соответственно на 22 процента и на 14 процентов меньше, чем у RA стартера (редукторного стартера типа A). Благодаря этому PS стартер обеспечивает лучшую топливную эффективность и отличается простотой установки.

Сегодня DENSO предлагает два усовершенствованных типа стартеров для вторичного рынка:

RA стартер

- > Высокоскоростной механизм с пониженным коэффициентом торможения и термостойким электрическим проводом имеет малый размер и вес
- > Холоднокованное шлицевое соединение уменьшает размер и вес втягивающего реле



PS Стартер

- > Провод обмотки с прямоугольным сечением и торцевой коллектор в обмотке вместе с магнитом, расположенным между главными полюсами вилки статора, уменьшают размер и вес стартера
- > Демпфер с пониженным коэффициентом торможения уменьшает габариты стартера и снижает уровень шума

Генераторы DENSO

В 1960-х годах компания DENSO впервые представила на рынке генераторы. С тех пор нам принадлежит первенство в разработке множества типов генераторов переменного тока, которые могут более эффективно производить электроэнергию при меньшем размере и весе. Например, в 2000 году компания DENSO представила первый в мире генератор с сегментным проводником, в котором для обмотки был использован провод, имеющий прямоугольное сечение. Повысив плотность заполнения с 45 процентов до 70 процентов, инженеры компании смогли уменьшить вес генератора на 20 процентов и добиться 50-процентного увеличения его производительности.

Сегодня DENSO предлагает два усовершенствованных типа генераторов для вторичного рынка:

Генератор с внутренним вентилятором

- > Оптимизация размеров статора и ротора улучшает параметры магнитной цепи и повышает производительность
- > Меньший диаметр шкива способствует увеличению скорости вращения ротора
- > Две лопасти вентилятора, объединенные с ротором, позволяют уменьшить шум вентилятора, его размер и вес



Генератор с сегментным проводником

- > Первый в мире проводник с прямоугольным сечением в обмотке статора позволяет увеличить плотность намотки, уменьшить вес генератора и повысить его производительность
- > Регулятор на одной интегральной микросхеме

RU

Технический чертеж: стартер

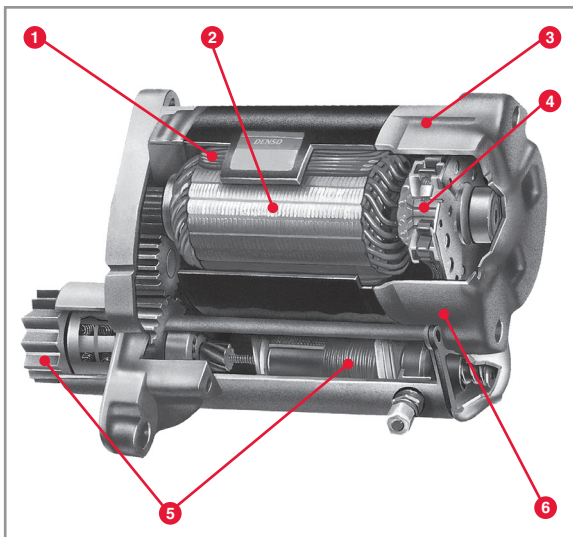

1. Катушка возбуждения
2. Ротор
3. Корпус
4. Коммутатор
5. Ведущая шестерня и втягивающее реле
6. Болт с зажимами

Технический чертеж: генератор

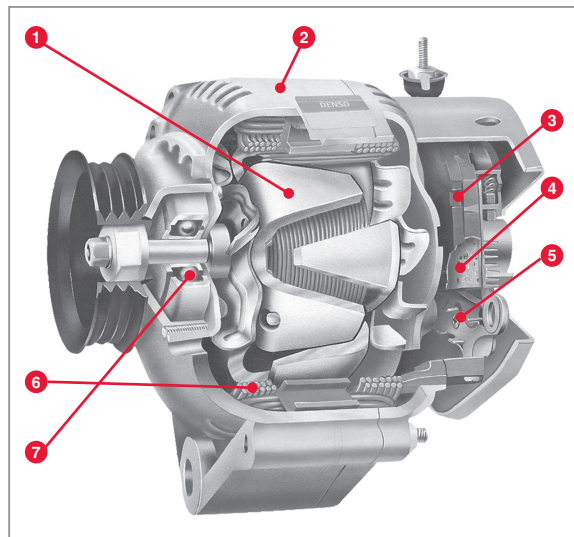

1. Ротор
2. Корпус
3. Контактное кольцо
4. Регулятор напряжения
5. Выпрямитель
6. Статор
7. Подшипник

La differenza DENSO

Progettazione avanzata. La stessa qualità dei prodotti di primo impianto (OEM). Prestazioni superiori. Queste sono le straordinarie qualità che caratterizzano tutti i motorini d'avviamento e gli alternatori DENSO per il mercato dei ricambi originali (OES), rese ora disponibili anche per il mercato Aftermarket.

DENSO, leader globale nello sviluppo e nella realizzazione di macchine rotanti, è uno dei principali fornitori di componenti per l'industria automobilistica. Grazie alla costante ricerca di soluzioni innovative e all'avanguardia dal punto di vista progettuale e qualitativo, i nostri motorini d'avviamento e alternatori vengono selezionati come componenti di primo impianto dai principali costruttori automobilistici a livello mondiale. DENSO viene costantemente premiata a livello internazionale per la qualità dei prodotti e del servizio prestato.

Per questo il programma di ricambi originali (OES) DENSO è in grado di offrire motorini d'avviamento e alternatori con le stesse caratteristiche qualitative dei componenti di primo impianto (OEM), realizzati con parti completamente nuove e senza componenti rigenerati. Ogni singolo pezzo viene realizzato mediante processi di produzione all'avanguardia e viene sottoposto a rigorosi test qualitativi, a garanzia di un prodotto che soddisfa gli standard più elevati sia in termini di prestazioni che di assemblaggio. Oltre a soddisfare le esigenze del primo impianto di costruttori automobilistici di primo piano come la Toyota e diversi costruttori europei, tra cui Ford, Opel, BMW, Fiat e Land Rover, il programma è in costante aggiornamento ed espansione. Il programma mira a coprire oltre 900 applicazioni entro il 2012.

Perché DENSO

- > Qualità di classe mondiale: prodotti qualitativamente identici ai componenti di primo impianto (OEM)
- > Tecnologia avanzata: componenti che integrano gli ultimi step qualitativi e tecnologici dei prodotti DENSO per il mercato OEM
- > Nessun componente rigenerato: nessun sovrapprezzo per mancato reso
- > Espansione continua: entro il 2012 il programma coprirà più di 900 applicazioni
- > Applicazioni esclusive: copertura capillare per la Toyota, e ampia copertura dei principali costruttori europei, tra cui Ford, Opel, BMW, Fiat e Land Rover
- > Efficienza: componenti leggeri e di dimensioni contenute che offrono nel contempo un rendimento particolarmente elevato

Se avete bisogno di un motorino d'avviamento o di un alternatore di ricambio, la scelta è una sola: DENSO.



Tecnologie leader nel mondo

Motorini d'avviamento DENSO

Dal momento della presentazione della sua prima linea commerciale di motorini d'avviamento per il settore automobilistico nei primi anni Sessanta, DENSO ha fatto leva sulle proprie competenze tecniche per lo sviluppo di dispositivi più compatti e leggeri in grado di garantire livelli prestazionali elevati. Per esempio, nel 2001 DENSO ha presentato il primo motorino d'avviamento al mondo con tecnologia PS (Planetary Reduction Segment Conductor Motor) dotato di conduttore a sezione rettangolare nell'avvolgimento del rotore. Grazie a una riduzione del 22 per cento in termini di peso e del 14 per cento in termini di lunghezza rispetto al motorino RA (Reduction A type), il motorino PS consentiva una maggiore facilità di assemblaggio e produceva una maggiore efficienza di alimentazione.

Oggi DENSO offre due tipi avanzati di motorino d'avviamento per il mercato Aftermarket:

Motorini d'avviamento RA

- > Motorino ad alta velocità a bassa inerzia che fanno uso di conduttori termostabili per gli avvolgimenti, permettendo di ridurre le dimensioni e il peso del motorino
- > Scanalatura forgiata a freddo che permette di ridurre le dimensioni e il peso del commutatore magnetico



Motorino d'avviamento PS

- > L'indotto, grazie a un commutatore superficiale e un conduttore a sezione rettangolare, in combinazione con un magnete tra gli elettrodi principali del nucleo, permette di ridurre le dimensioni e il peso del motorino d'avviamento
- > L'uso di uno smorzatore e la bassa inerzia consentono di ridurre ulteriormente le dimensioni e la rumorosità del motorino d'avviamento

Alternatori DENSO

DENSO ha presentato la prima serie di alternatori per applicazioni automobilistiche nel 1960. Da allora l'azienda nipponica è sempre stata all'avanguardia nel settore, realizzando dispositivi sempre più piccoli e leggeri che adottano soluzioni innovative mirate in modo specifico a sviluppare una maggiore potenza ed efficienza. Per esempio, nel 2000 DENSO ha presentato il primo alternatore al mondo con tecnologia SC (Segment Conductor) dotato di avvolgimento dello statore a conduttore a sezione rettangolare. Con l'aumento della densità dell'avvolgimento (coefficiente di riempimento) da 45 a 70 per cento, l'alternatore SC è risultato più leggero del 20 per cento e più efficiente del 50 per cento rispetto a un alternatore di tipo convenzionale.

Oggi DENSO offre due tipi di alternatori avanzati per il mercato Aftermarket:

Alternatore con piccola ventola interna

- > Statore e dimensioni del rotore ottimizzati per aumentare l'efficienza del circuito magnetico e migliorare la potenza
- > Diametro ridotto della puleggia per un rotore più veloce
- > Ventola a due pale, combinata con il rotore per ridurre le dimensioni, il peso e la rumorosità della ventola



Alternatore SC

- > Il primo conduttore a sezione rettangolare nell'avvolgimento dello statore al mondo aumenta la densità dell'avvolgimento, riduce il peso e aumenta la potenza
- > Regolatore IC one-chip

I

Disegni tecnici: motorino d'avviamento

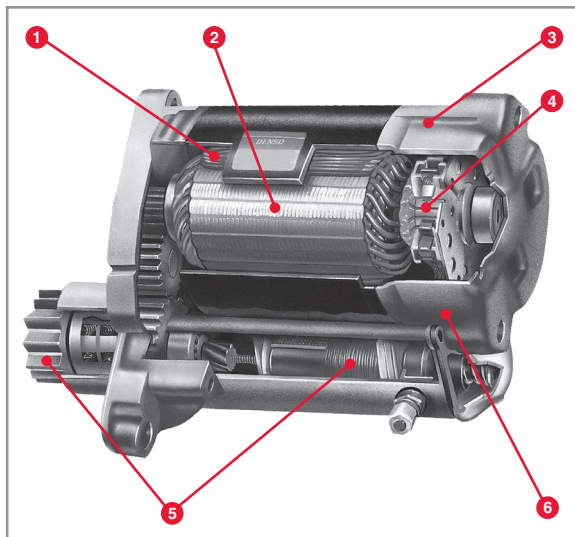

1. Bobina d'eccitazione
2. Indotto
3. Corpo
4. Commutatore
5. Ingranaggio pignone avvolgimento solenoide
6. Bullone terminale alimentazione

Disegni tecnici: alternatore

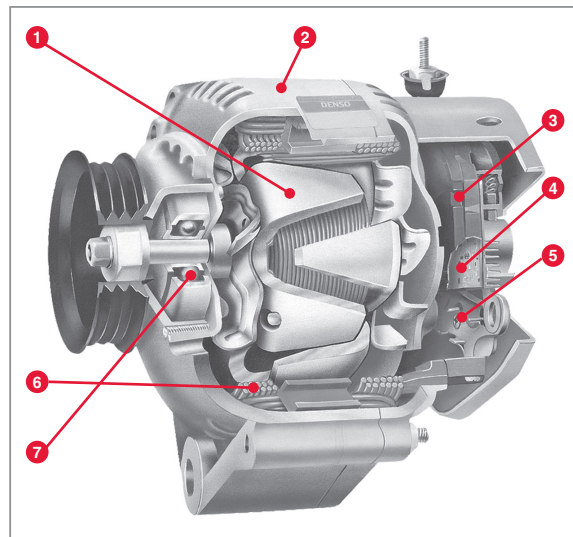

1. Rotore
2. Corpo
3. Anello collettore
4. Regolatore di tensione
5. Raddrizzatore
6. Statore
7. Cuscinetto

La diferencia de DENSO

Diseño avanzado. Fabricación con la calidad de primeros equipos. Altas prestaciones. Éstos son los valores excepcionales que respaldan a los motores de arranque y alternadores de recambio de DENSO, transfiriendo la tecnología de máquinas rotativas avanzadas directamente a la posventa.

Uno de los mayores proveedores de componentes de automoción del mundo, DENSO es un líder global en el desarrollo y fabricación de máquinas rotativas. Nuestro firme compromiso de calidad, diseño e innovación sobresalientes hace que los fabricantes de vehículos seleccionen nuestros motores de arranque y alternadores como primeros equipos, recibiendo al mismo tiempo numerosos galardones internacionales de calidad y homologaciones de proveedor.

Basado en esta experiencia, el programa de motores de arranque y alternadores de recambio de DENSO ofrece las especificaciones de los primeros equipos, con piezas completamente nuevas, no remanufacturadas. Cada producto se somete a nuestros rigurosos procedimientos de fabricación y ensayos, por lo que puede asegurarse el cumplimiento de los más estrictos criterios de montaje y prestaciones. Además de ofrecer una cobertura única de los primeros equipos de Toyota y una amplia variedad de marcas europeas como Ford, Opel, BMW, Fiat y Land Rover, el programa se encuentra en constante actualización y expansión, con planes para una cobertura de más de 900 aplicaciones en 2012.

¿Por qué DENSO?

- > Calidad de primera clase: fabricados con las especificaciones de los primeros equipos
- > Tecnologías avanzadas: incorporando las últimas tecnologías y modificaciones de los primeros equipos de DENSO
- > No hay unidades remanufacturadas: sin cargos por cascos ni políticas de devolución
- > Expansión constante: el programa ofrecerá más de 900 aplicaciones en 2012
- > Aplicaciones únicas: cobertura única de Toyota más una amplia gama de marcas europeas, incluyendo Ford, Opel, BMW, Fiat y Land Rover
- > Rendimiento: ligeros y de dimensiones reducidas, pero de altas prestaciones

Cuando necesite un motor de arranque o un alternador de recambio, sólo hay una elección: DENSO.



Tecnologías de vanguardia

Motores de arranque DENSO

Desde la introducción de sus primeros motores de arranque para vehículos industriales a principios de la pasada década de los años sesenta, DENSO ha dedicado sus conocimientos técnicos de vanguardia al desarrollo de unidades más pequeñas y ligeras capaces de mantener las máximas prestaciones posibles. En 2001, por ejemplo, DENSO introdujo el motor de arranque PS, el primero en el mundo con reducción planetaria y conductor de sección cuadrada en la bobina del inducido. El motor de arranque PS era un 22% más ligero y un 14% más corto que el motor de arranque de reducción A (RA).

En la actualidad, DENSO ofrece dos tipos avanzados de motores de arranque para los clientes de posventa:

Motor de arranque RA

- > Un motor de arranque de alta velocidad con una mejor relación de deceleración, y un tipo de conductor eléctrico resistente al calor que reduce el tamaño y el peso de la unidad
- > El eje acanalado forjado en frío reduce el tamaño y el peso del accionamiento electromagnético



Motor de arranque PS

- > El conductor de sección rectangular y el colector de superficie, junto con un imán entre los electrodos principales de la carcasa, reducen el tamaño y el peso del motor de arranque
- > El amortiguador, junto con la alta relación de deceleración, reducen aún más el peso además del ruido del motor de arranque

Alternadores DENSO

DENSO introdujo sus primeros alternadores de automoción en la pasada década de los años sesenta. Desde entonces, hemos sido pioneros con una variedad de diseños de alternadores capaces de generar más energía eléctrica de forma más eficiente, con unidades de tamaño y peso menores. En 2000, por ejemplo, DENSO introdujo el alternador SC, el primero con un conductor de sección rectangular en la bobina del estátor. Con el incremento de la densidad del devanado del 45% al 70%, conseguimos hacer el alternador SC un 20% más ligero y obtener un 50% más de potencia que con los alternadores convencionales

En la actualidad, DENSO ofrece dos tipos avanzados de alternadores para los clientes de posventa:

Alternador con un pequeño ventilador interior

- > Las dimensiones optimizadas del estátor y el rotor mejoran el circuito magnético, aumentando la potencia obtenida
- > El menor diámetro de la polea permite tener un rotor más rápido
- > Un ventilador de dos palas integrado con el rotor para reducir el ruido, el tamaño y el peso del ventilador



Alternador SC

- > La primera bobina de estátor del mundo con conductor de sección rectangular que permite aumentar la densidad del devanado, reducir el peso, y aumentar la potencia
- > Un regulador de circuito integrado

E

Plano: Motor de arranque

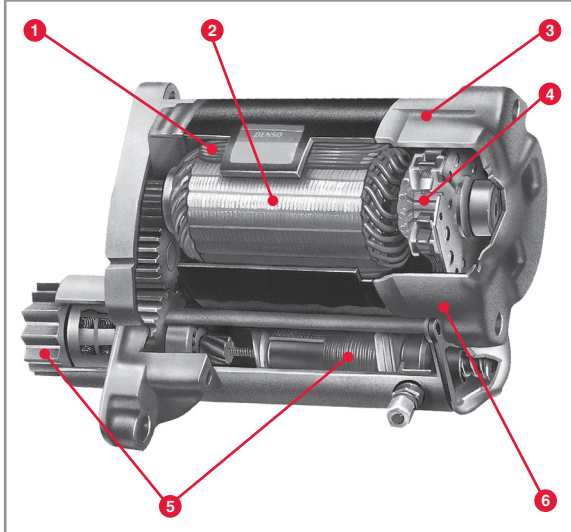

1. Bobina inductora
2. Inducido
3. Cuerpo
4. Colector
5. Piñón-bobina
6. Terminal

Plano: Alternador

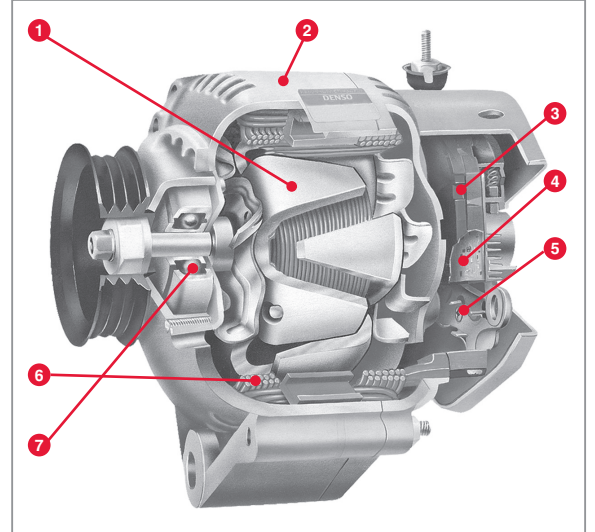

1. Rotor
2. Cuerpo
3. Anillo colector
4. Regulador de tensión
5. Regulador de tensión
6. Estátor
7. Cojinete

La différence DENSO

Conception évoluée. Fabrication de qualité équipement d'origine (OE). Haute performance. Telles sont les normes exceptionnelles qui caractérisent les démarreurs et les alternateurs DENSO de deuxième monte, mettant la technologie de classe mondiale des machines tournantes à portée directe du marché de la rechange.

Présente parmi les plus grands fournisseurs internationaux de pièces automobiles, la marque DENSO est leader mondial en matière de développement et de fabrication de machines tournantes. Grâce à notre engagement inébranlable à fournir une qualité, une conception et une innovation exceptionnelles, nos démarreurs et nos alternateurs sont sélectionnés par les constructeurs automobiles du monde entier, remportant au passage de nombreuses récompenses décernées aux fournisseurs et de nombreux prix internationaux de la Qualité.

Fort de ces compétences, le programme DENSO de démarreurs et d'alternateurs de rechange offre des caractéristiques techniques de qualité OE et des pièces entièrement neuves, sans composants ré-usinés. Chaque machine fait l'objet de procédés rigoureux de fabrication et d'essai, vous pouvez donc être sûr qu'elle répond aux normes les plus élevées de montage et de performance. En plus de sa couverture unique OE de Toyota et d'un grand nombre de marques européennes telles que Ford, Opel, BMW, Fiat et Land Rover, le programme est constamment mis à jour et augmenté pour couvrir plus de 900 applications d'ici 2012.

Pourquoi DENSO

- > Qualité de classe mondiale : conforme aux spécifications OE
- > Technologies évoluées : intégrant les technologies et les modifications de production de qualité OE les plus récentes de DENSO
- > Pas de pièces ré-usinées : pas de supplément de remise en état ni de politique de renvoi
- > Expansion continue : le programme offrira plus de 900 applications d'ici 2012
- > Affectations uniques : couverture inégalée des applications Toyota à laquelle s'ajoute un vaste éventail de marques européennes dont Ford, Opel, BMW, Fiat, Land Rover
- > Efficacité : petits et légers tout en assurant un haute rendement

Lorsqu'il vous faut un démarreur ou un alternateur de rechange, un seul nom s'impose : DENSO.

Technologies leaders mondiales

Démarreurs DENSO

Depuis l'introduction de ses premiers démarreurs automobiles commerciaux au début des années 60, DENSO a consacré ses compétences techniques de premier rang mondial au développement de produits plus petits et plus légers capables de maintenir le rendement le plus élevé possible. En 2001, par exemple, DENSO a introduit en première mondiale le démarreur à moteur à segment conducteur et réduction planétaire (PS) doté d'un conducteur rectangulaire dans la bobine d'induit. Le démarreur PS était 22% plus léger et 14% plus court que le démarreur du type à Réduction A (RA), assurant une meilleure efficacité de carburant et un montage simplifié.

Actuellement, DENSO offre deux types de démarreurs évolués aux clients du marché de la rechange:

Démarreur RA

- > Moteur à grande vitesse avec rapport d'accélération amélioré et fil électrique résistant à la chaleur, réduisant sa taille et son poids
- > Cannelure forgée à froid réduisant la taille et le poids du solénoïde



Démarreur PS

- > Un conducteur rectangulaire et un commutateur de surface, avec un aimant entre les électrodes principales du boîtier, réduisent la taille et le poids du démarreur
- > L'atténuateur, ainsi qu'un rapport élevé de décélération, diminuent encore plus la taille du démarreur et le bruit de conduite

Alternateurs DENSO

DENSO a introduit ses premiers alternateurs automobiles dans les années 60. Depuis, nous avons été les premiers à créer de nombreux modèles innovateurs d'alternateurs, capables de produire plus de puissance électrique de manière plus efficace, dans un produit pourtant plus petit et plus léger. En 2000, par exemple, DENSO a présenté le premier alternateur SC (Segment Conducteur) au monde, utilisant un conducteur rectangulaire pour sa bobine de stator. En augmentant la densité d'enroulement (facteur d'espace) de 45 pour cent à 70 pour cent, nous avons réussi à réduire le poids de l'Alternateur SC de 20% et à obtenir un rendement 50% plus élevé que sur un produit classique.

Actuellement, DENSO offre deux types d'alternateurs évolués aux clients du marché de la rechange:

Alternateur avec petit ventilateur interne

- > La taille optimisée du stator et du rotor améliore le circuit magnétique pour augmenter le rendement
- > Le diamètre réduit de poulie permet un rotor plus rapide
- > Le ventilateur possède deux pales, intégrées au rotor, afin de réduire le bruit du ventilateur, la taille et le poids



Alternateur SC

- > Le premier conducteur rectangulaire au monde dans la bobine de stator augmente la densité de l'enroulement, réduit le poids et augmente le rendement
- > Régulateur en circuit intégré à puce unique



F

Schéma technique: Démarreur

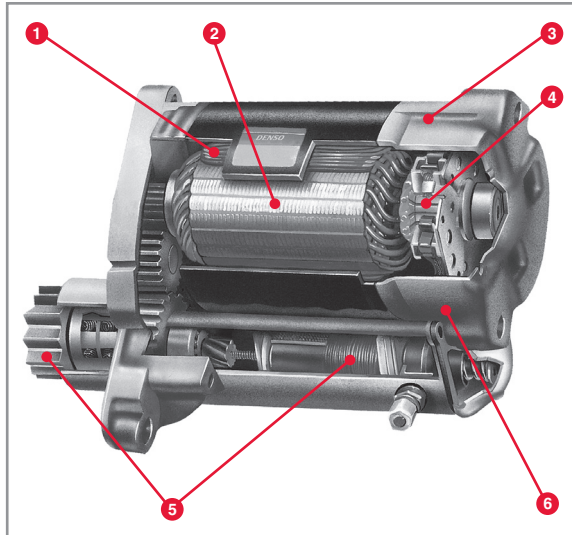

1. Inducteur
2. Induit
3. Carter
4. Commutateur
5. Bobine de commande
6. Vis de borne

Schéma technique: Alternateur

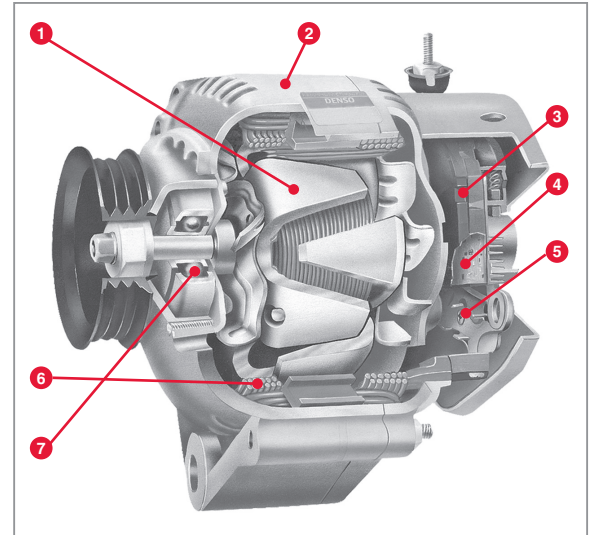

1. Rotor
2. Carter
3. Bague collectrice
4. Régulateur de tension
5. Pont redresseur
6. Stator
7. Roulement

Skillnaden med DENSO

Avancerad konstruktion. Tillverkning i OE-kvalitet. Kraftfull prestanda. Det här är de exceptionella egenskaperna som ligger till grund för DENSOs utbytesgeneratorer och -startmotorer – teknologi för roterande maskiner i världsklass direkt till eftermarknaden.

DENSO, en av världens största leverantörer av fordonskomponenter, är en global ledare inom utveckling och tillverkning av roterande maskiner. Vårt åtagande när det gäller enastående kvalitet, design och innovation innebär att våra startmotorer och generatorer väljs som originalutrustning av biltillverkare över hela världen – och vinner flera leverantörsutmärkelser och internationella kvalitetsutmärkelser längs vägen.

DENSOs program med utbytesgeneratorer och -startmotorer, som bygger på den här expertisen, erbjuder OE-specifikationer med helt nya delar utan några återtillverkade enheter. Varje maskin genomgår DENSOs rigorösa tillverknings- och testningsprocesser, så att du kan vara säker på att de uppfyller de högsta standarderna gällande tillförlitlighet och prestanda. Förutom att programmet tillhandahåller unik OE-täckning av Toyota och ett stort antal europeiska märken, som Ford, Opel, BMW, Fiat och Land Rover, uppdateras och utvidgas programmet kontinuerligt, och planeras omfatta fler än 900 tillämpningar år 2012.

Varför DENSO

- > Kvalitet i världsklass: Tillverkad till OE-specifikationer
- > Avancerade teknologier: Innefattar DENSOs senaste OE-teknologier och OE-produktionsmodifieringar
- > Inga återtillverkade enheter: Utbytt enhet behöver inte returneras till DENSO
- > Kontinuerlig expansion: Programmet kommer erbjuda fler än 900 tillämpningar 2012
- > Unika tillämpningar: Överträffat produktutbud för Toyota och för ett stort antal europeiska märken, inklusive Ford, Opel, BMW, Fiat och Land Rover
- > Effektivitet: Liten storlek och vikt men hög verkningsgrad

När en utbytesgenerator eller -startmotor behövs finns bara ett självklart val: DENSO.

Världsledande teknologier

DENSO startmotorer

Efter introduktionen av sina första kommersiella startmotorer för fordon under tidigt 60-tal har DENSO använt sin världsledande tekniska expertis på utveckling av mindre, lättare enheter som kan upprätthålla högsta möjliga effekt under längsta möjliga tid. År 2001 lanserade DENSO t.ex. världens första startmotor med planetreduktionsväxel och segmentledare (PS-motor), samt fyrkantig ledare i spolen. PS-startmotorn var 22 % lättare och 14 % kortare än reduktionsmotorer av A-typ (RA-motor), och erbjuder bättre bränsleekonomi och enklare installation.

Idag erbjuder DENSO eftermarknadskunderna två avancerade typer av startmotorer:

RA-motor

- > Höghastighetsmotor med snabbare inbromsning och en värmebeständig ledning, vilket minskar motorns storlek och vikt
- > Kallbearbetad tapp minskar magnetkontaktens storlek och vikt



PS-motor

- > En rektangulär ledare och strömmomkastare i armaturen, tillsammans med en magnet mellan statorns huvudelektroder, minskar startmotorns storlek och vikt
- > Dämpningsenheten tillsammans med snabb inbromsning minskar startmotorns storlek ytterligare och reducerar ljudnivån

DENSO generatorer

DENSO lanserade sina första generatorer för fordon på 60-talet. Sedan dess har vi varit föregångare när det gäller många nya generatorkonstruktioner som kan generera mer elkraft på ett effektivare sätt och i en mindre och lättare enhet. År 2000 lanserade DENSO t.ex. världens första SC-generator (Segment Conductor), där en rektangulär ledare användes i statorspolen. Genom att öka lindningsdensiteten (utrymmesfaktor) från 45 % till 70 % kunde vi göra SC-generatorn 20 % lättare och åstadkomma 50 % högre effekt jämfört med konventionella generatorer.

Idag erbjuder DENSO eftermarknadskunderna två olika avancerade typer av generatorer:

Generator med liten intern fläkt

- > Optimerade stator- och rotorstorlekar förbättrar den magnetiska kretsen vilket ger större uteffekt
- > Mindre diameter på remskivan medger snabbare rotor
- > Fläkten har två blad som är integrerade i rotorn för att minska fläktljudet, storleken och vikten



SC-generator

- > Världens första rektangulära ledare i statorspolen ökar lindningsdensiteten och uteffekten, samt minskar vikten
- > IC-regulator med ett chip



SE

Ritning över enhet: Startmotor

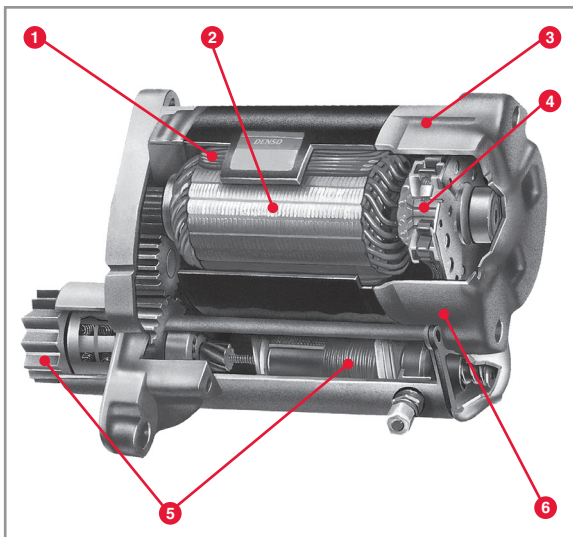

1. Fältspole
2. Armatur
3. Inneslutning
4. Strömmkastare
5. Magnetspole för kuggdrev
6. Plintbult



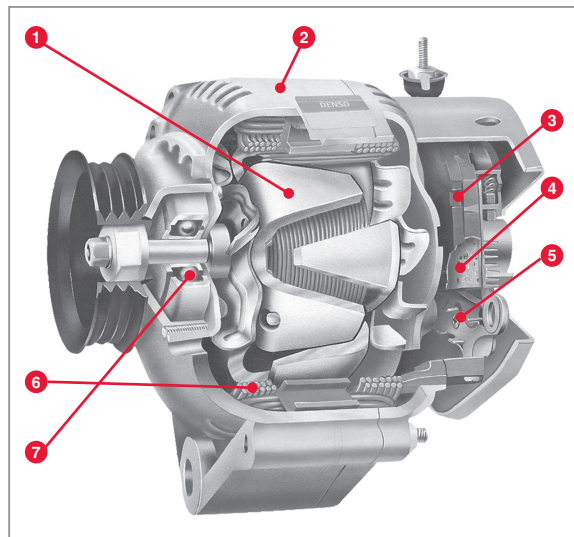







Ritning över enhet: Generator



1. Rotor
2. Inneslutning
3. Släpring
4. Spänningsregulator
5. Likriktare
6. Stator
7. Lager

Starters & Alternators

Abbreviations

	GB	DE	FR	ES	IT	SE	PL	RU
	Vehicle, Make, Model, Engine Capacity	Fahrzeug, Marke, Modell, Hubraum	Véhicule, Marque, Modèle, Cylindrée	Vehículo, Marca, modelo, cilindrada del motor	Veicolo, Marca, Modello, Cilindrata	Fordon, Märke, Modell, Motorvolym	Pojazd, marka, model, pojemność silnika	Автомобиль, марка, модель, литраж двигателя
	Fuel	Kraftstoff	Carburant	Combustible	Alimentazione	Bränsle	Paliwo	Топливо
 kW	Engine Power	Motorleistung	Puissance du moteur	Potencia del motor	Potenza motore	Motoreffekt	Moc silnika	Мощность двигателя
	Engine Code	Motorcode	Code du moteur	Código del motor	Numero motore	Motorkod	Kod silnika	Код двигателя
	Year (from - to)	Jahr (von - bis)	Année (de - à)	Año (de - a)	Anno (da - a)	År (från- till)	Rok (od - do)	Год (с - до)
	Transmission	Getriebe	Transmission	Transmisión	Trasmissione	Växellåda	Skrzynia biegów	Коробка передач
	Part Number - Starter	Teilenummer - Anlasser	Numéro de pièce - Démarreurs	Número referencia - Motores de Arranque	Codice articolo - Motorini d'avviamento	Delnummer - Startmotorer	Nr katalogowy - Rozruszniki	Каталожный номер - для стартеров
	Part Number - Alternator	Teilenummer - Lichtmaschinen	Numéro de pièce - Alternateurs	Número referencia - Alternadores	Codice articolo - Alternatori	Delnummer - Generatorer	Nr katalogowy - Alternatory	Каталожный номер - для генераторов
	Additional Information	Zusätzliche Informationen	Information complémentaire	Información suplementaria	Informazioni supplementari	Ytterligare information	Informacje dodatkowe	Дополнительная информация
	Rated Voltage (V)	Nennspannung V	Tension nominal V	Voltaje clasificado (V)	Tensione (V)	Märkspänning V	Napięcie znamionowe V	Номинальное Напряжение V
A	Rated Current (Ampere)	Nennstrom (ampere)	Courant nominal (Ampere)	Corriente nominal (Amperios)	Corrente nominale (Ampere)	Nominell aktuella (ampere)	Prąd (ampere)	Номинальный Поток (Ампер)
kW	Rated Power (kiloWatt)	Steuerpflichtige Energie(kw)	Puissance nominale (kw)	Potencia nominal (kw)	Potenza nominale (kw)	Nominell effekt (kw)	Moc znamionowa (kw)	Номинальная Энергия (kw)
- AC	For vehicles without air conditioner	Für Fahrzeuge ohne Klimaanlage	Pour véhicules sans climatisation	Para vehículos sin aire acondicionado	Per veicoli senza climatizzatore	För fordon utan luftkonditionering	Dla pojazdów bez klimatyzacji	Для автомобилей без кондиционера
- EAH	For vehicles without electrical auxiliary heater	Für Fahrzeuge ohne Zusatzheizgerät	Pour véhicules sans chauffage électrique auxiliaire	Para vehículos sin calefacción eléctrica auxiliar	Per veicoli privi di riscaldatore elettrico ausiliario	För fordon utan elektrisk hjälpvärmare	Dla pojazdów bez elektrycznego podgrzewacza pomocniczego	Для автомобилей без электрического дополнительного отопителя
- PH	For vehicles without parking heater	Für Fahrzeuge ohne Standheizung	Pour véhicules sans chauffage de stationnement	Para vehículos sin calefacción de estacionamiento	Per veicoli privi di riscaldatore di parcheggio	För fordon utan parkeringsvärmare	Dla pojazdów bez ogrzewania parkingowego	Для автомобилей без стояночного подогревателя
- POC	Not for production option code	Nicht für Produktionscode	Code pour option non en production	Código para opción de no producción	Codice di opzione Non in produzione	Kod för tillval som inte tillverkas	Nie stosować w pojazdach z kodami opcji	Не для производственного кода опции
- PS	For vehicles without power steering	Für Fahrzeuge ohne Servolenkung	Pour véhicules sans direction assistée	Para vehículos sin dirección asistida	Per veicoli privi di servosterzo	För fordon utan servostyrning	Dla pojazdów bez wspomagania kierownicy	Для автомобилей без усилителя руля
- SS	For vehicles without stop-start system	Für Fahrzeuge ohne Start-stop System	Pour véhicules sans système stop-start	Para vehículos sin sistema de parada y arranque	Per veicoli privi di sistema Stop-Start	För fordon utan stopp-startsystem	Dla pojazdów bez systemu stop-start	Для автомобилей без системы Старт-Стоп
+ AC	For vehicles with air conditioner	Für Fahrzeuge mit Klimaanlage	Pour véhicules avec climatisation	Para vehículos con aire acondicionado	Per veicoli con climatizzatore	För fordon med luftkonditionering	Dla pojazdów z klimatyzacją	Для автомобилей с кондиционером
+ Co	For cold climates	Für kaltes Klima	Pour climats froids	Para climas fríos	Per climi freddi	För kalla klimat	Dla zimnych klimatów	Для холодного климата
+ EAH	For vehicles with electrical auxiliary heater	Für Fahrzeuge mit elektrischer Zusatzheizung	Pour véhicules avec chauffage auxiliaire électrique	Para vehículos con calefacción eléctrica auxiliar	Per veicoli con riscaldatore elettrico ausiliario	För fordon med elektrisk hjälpvärmare	Dla pojazdów z elektrycznym podgrzewaczem pomocniczym	Для автомобилей с электрическим дополнительным отопителем
+ EH	for vehicles with extra heating	Für Fahrzeuge mit Extra Heizung	pour véhicules avec chauffage additionnel	Para vehículos con calefacción suplementaria	per veicoli con riscaldatore addizionale	för fordon med extravärme	dla pojazdów z dodatkowym ogrzewaniem	Для автомобилей с улучшенным обогревом (Северная Европа) / дополнительным обогревом
+ FDC	For dusty conditions	Für staubiges Klima	Pour conditions poussiéreuses	Para condiciones con polvo	Per condizioni polverose	För dammiga förhållanden	Stosować w zapylnych środowiskach	Для пыльных условий эксплуатации
+ Ho	For hot climates	Für heißes Klima	Pour climats chauds	Para climas cálidos	Per climi caldi	För varma klimat	Dla gorących klimatów	Для жаркого климата
+ HWS	For vehicles with heated windscreen	Für Fahrzeuge mit beheizbaren Windschutzscheiben	Pour véhicules avec pare-brise chauffant	Para vehículos con parabrisas calefactados	Per veicoli con parabrezza termico	För fordon med uppvärmd vindruta	Dla pojazdów z ogrzewaną przednią szybą	Для автомобилей с обогревом лобового стекла
+ LS	With load sensing	Mit Lasterfassung	Avec détection de charge	Con sensor de carga	Con rilevamento del carico	Med lastsensor	Z czujnikiem obciążenia	С проверкой нагрузки
+ PH	For vehicles with parking heater	Für Fahrzeuge mit Standheizung	Pour véhicules avec chauffage stationnaire	Para vehículos con calefacción de estacionamiento	Per veicoli con riscaldatore di parcheggio	För fordon med parkeringsvärmare	Dla pojazdów z ogrzewaniem parkingowym	Для автомобилей со стояночным подогревателем

	GB	DE	FR	ES	IT	SE	PL	RU
+ PR	For option code	Für Optionscode	Pour code d'option	Para código de opción	Per l'opzione codice	För tillvalskod	Zastosowanie samochodowy z kodami opcji	Для кода опции
+ PS	For vehicles with power steering	Für Fahrzeuge mit Servolenkung	Pour véhicules avec direction assistée	Para vehículos con dirección asistida	Per veicoli con servosterzo	För fordon med servostyrning	Dla pojazdów ze wspomaganiem kierownicy	Для автомобилей с усилителем руля
+ RUS	For vehicles use in Russia	Für Fahrzeuge in Russland	Pour véhicules utilisés en Russie	Para vehículos en Rusia	Per veicoli utilizzati in Russia	För fordon som används i Ryssland	Dla pojazdów używanych w Rosji	Для автомобилей российского рынка
+ SS	For vehicles with stop-start system	Für Fahrzeuge mit Start-stop System	Pour véhicules avec système stop-start	Para vehículos con sistema de parada y arranque	Per veicoli con sistema Stop-Start	För fordon med stopp-startsystem	Dla pojazdów z systemem stop-start	Для автомобилей с системой Старт-Стоп
+ TUR	For vehicles use in Turkey	Für Fahrzeuge in der Türkei	Pour véhicules utilisés en Turquie	Para vehículos en Turquía	Per veicoli utilizzati in Turchia	För fordon som används i Turkiet	Dla pojazdów używanych w Turcji	Для автомобилей турецкого рынка
+ VP	with integrated vacuum pump	Mit integrierter Vakuumpump	avec pompe à vide intégrée	Con bomba de vacío integrada	con pompa del vuoto integrata	med inbyggd vakuumpump	ze zintegrowaną pompą podciśnienia	Со встроенным вакуумным насосом
4ATM	4-speed automatic transmission	Viergang-Automatikgetriebe	transmission automatique 4 vitesses	Transmisión automática de 4 velocidades	Cambio automatico a 4 rapporti	4-växlad automatväxellåda	4-biegowa automatyczna skrzynia biegów	Автоматическая КПП 4-х ступенчатая
5MTM	5-Speed manual transmission	Füfngang-Schaltgetriebe	Transmission manuelle 5 vitesses	Transmisión manual de 5 velocidades	Cambio manuale a 5 marce	5-Växlad manuell växellåda	5-Cio biegowa manualna skrzynia biegów	5-скоростная МКПП
6MTM	6-Speed manual transmission	Sechsgang-Schaltgetriebe	Transmission manuelle 6 vitesses	Transmisión manual de 6 velocidades	Cambio manuale a 6 marce	6-Växlad manuell växellåda	6-Cio biegowa manualna skrzynia biegów	6-скоростная МКПП
AMT	Automated Manual Transmission	Automatisiertes Handschaltgetriebe	Transmission manuelle pilotée	Transmisión manual automatizada	Cambio semiautomatico	Halvautomatisk växellåda	Zautomatyzowana manualna skrzynia biegów	Роботизированная КПП
ATM	Automatic transmission	Automatikgetriebe	Transmission automatique	Transmisión automática	Cambio automatico	Automatisk växellåda	Automatyczna skrzynia biegów	АКПП
BO	Interchangeable with Bosch product	Austauschbar mit Bosch Produkt	Interchangeable avec un produit Bosch	Intercambiable con el producto Bosch	Intercambiabile con prodotto Bosch	Utbyttbar mot produkt från Bosch	Zamienny z produktem Bosch	Взаимозаменяемый с продукцией Bosch
Ch No	Chassis no	Fahrgestellnummer	No. de châssis	Número de bastidor	No chassis	Chassinr.	Nr podwozia	Номер шасси
Eng No	Engine no	Motornummer	No. de moteur	Número de motor	No motore	Motornr.	Nr silnika	Тип (код) двигателя
EU4, EU5, EU6	Exhaust Emission Norms	Abgasnormen	Normes d'émissions (d'échappement)	Normas sobre emisiones de los gases de escape	Normative sulle emissioni gas di scarico	Avgasnormer	Normy emisji	Нормы по содержанию СО и СН в выхлопных газах
EUR	For vehicles produced in Europe	Für in Europa hergestellte Fahrzeuge	Pour véhicules fabriqués en Europe	Para vehículos fabricados en Europa	Per veicoli prodotti in Europa	För fordon tillverkade i Europa	Dla pojazdów wyprodukowanych w Europie	Для автомобилей, сделанных в Европе
FRA	For vehicles produced in France	Für in Frankreich hergestellte Fahrzeuge	Pour véhicules fabriqués en France	Para vehículos fabricados en Francia	Per veicoli prodotti in Francia	För fordon tillverkade i Frankrike	Dla pojazdów wyprodukowanych we Francji	Для автомобилей, сделанных во Франции
HI	Interchangeable with Hitachi product	Austauschbar mit Hitachi Produkt	Interchangeable avec produit Hitachi	Intercambiable con producto Hitachi	Intercambiabile con i prodotti Hitachi	Utbyttbar mot Hitachi-produkt	Zamienny z produktem Hitachi	Деталь взаимозаменяема с продукцией HITACHI
JPN	For vehicles produced in Japan	Für in Japan hergestellte Fahrzeuge	Pour véhicules fabriqués au Japon	Para vehículos fabricados en Japón	Per veicoli prodotti in Giappone	För fordon tillverkade i Japan	Dla pojazdów wyprodukowanych w Japonii	Для автомобилей, сделанных в Японии
LHD	For left-hand drive vehicles	Für linksgelenkte Fahrzeuge	Pour véhicules avec conduite à gauche	Para vehículos con volante a la izquierda	Per veicoli con guida a sinistra	För vänsterstyrda fordon	Dla pojazdów z lewostronnym układem kierowniczym	Для автомобилей с левым рулем
MTM	Manual Transmission	Schaltgetriebe	Transmission manuelle	Transmisión manual	Cambio manuale	Manuell växellåda	Ręczna skrzynia biegów	Ручная трансмиссия
RIC	Ricambi No	Teilenummer	Nos. de pièces détachées	Recambio nº	Numero Ricambi	Reservdelsnummer	Nr RIC	Номер запчасти
RHD	For right-hand drive vehicles	Für rechtsgelenkte Fahrzeuge	Pour véhicules avec conduite à droite	Para vehículos con volante a la derecha	Per veicoli con guida a destra	För högerstyrda fordon	Dla pojazdów z prawostronnym układem kierowniczym	Для автомобилей с правым рулем
RPO	Vehicle Production Date Code	Fahrzeugproduktions Datumcode	Code date de fabrication du véhicule	Código de fecha de fabricación del vehículo	Codice data produzione veicolo	Fordonets produktionsdatumkod	Kod daty produkcji pojazdu	Код даты производства автомобиля
SMT	Sequential Manual Transmission	sequenzielles Schaltgetriebe	Transmission manuelle séquentielle	Transmisión manual secuencial	Cambio manuale sequenziale	Sekventiell manuell växellåda	Sekwencyjna ręczna skrzynia biegów	Секвентальная ручная трансмиссия
TRN	Transmission Type	Antriebsart	Type de transmission	Tipo de transmisión	Tipo di cambio	Typ av växellåda	Rodzaj skrzyni biegów	Тип трансмиссии
VA	Interchangeable with Valeo product	Austauschbar mit Valeo Produkt	Interchangeable avec un produit Valeo	Intercambiable con el producto Valeo	Intercambiabile con prodotto Valeo	Utbyttbar mot Valeo-produkt	Zamienny z produktem Valeo	Взаимозаменяемый с продукцией Valeo
ZAF	For vehicles produced in South Africa	Für in Südafrika produzierte Fahrzeuge	Pour véhicules construits en Afrique du Sud	Para vehículos fabricados en Sudáfrica	Per veicoli prodotti in Sud Africa	För fordon tillverkade i Sydafrika	Dla pojazdów wyprodukowanych w RPA	Для автомобилей, сделанных в ЮАР











DENSO Application Tables – Starters















kW











ALFA ROMEO									
145 / 146 (94-01)									
1.4 i.e. 16V T.Spark	Petrol	76	AR 33503		11/96-01/01		DSN579	12	1.4
1.6 i.e. 16V T.Spark	Petrol	88	AR 67601		11/96-10/01		DSN579	12	1.4
1.8 i.e. 16V	Petrol	106	AR 32201		03/98-01/01		DSN579	12	1.4
1.8 i.e. 16V T.Spark	Petrol	103	AR 67106		11/96-02/99	Ch No: 92747>	DSN579	12	1.4
1.8 i.e. 16V T.Spark	Petrol	103/106	AR 32201;AR 67106; AR 67199		12/96-01/01		DSN579	12	1.4
1.9 JTD	Diesel	77	AR 32302		02/99-01/01		DSN3018	12	2
1.9 TD	Diesel	66	AR 33601;AR 67501		10/94-02/99		DSN579	12	1.4
1.9 TD	Diesel	66	AR 33601;AR 67501	MTM	12/94-02/99		DSN579	12	1.4
2.0 16V	Petrol	114	AR 32301		03/97-10/01		DSN579	12	1.4
2.0 16V T.Spark	Petrol	110	AR 67204	MTM	10/95-01/01		DSN579	12	1.4
147 (00-10)									
1.6 16V T.Spark	Petrol	88	AR 32104		01/01-03/10	Ch No: >3086002	DSN579	12	1.4
1.6 16V T.Spark eco	Petrol	77	AR 37203	MTM	01/01-03/10	Ch No: >3086002	DSN579	12	1.4
1.6 LPG	Petrol/ Liquified Petroleum Gas (LPG)	77/88	AR 32104;AR 37203		03/01-03/10		DSN579	12	1.4
1.9 JTD 16V	Diesel	93/100/ 103	192 A5.000;192 B1.000; 937 A4.000		11/02-03/10		DSN3018	12	2
1.9 JTD 8V	Diesel	74/81/85	182 B9.000;937 A2.000		10/00-03/10		DSN3018	12	2
1.9 JTDM 16V	Diesel	110/125	937 A5.000;937 A6.000		09/04-03/10		DSN3018	12	2
1.9 JTDM 8V	Diesel	85/88	937 A3.000;939 A7.000		10/04-03/10		DSN3018	12	2
2.0 16V T.Spark	Petrol	110	AR 32310		01/01-09/04		DSN579	12	1.4
155 (92-97)									
1.7 T.Spark	Petrol	103	AR 67106	MTM	05/96-12/97		DSN579	12	1.4
2.0 T.Spark	Petrol	110	AR 67204;AR 67299	MTM	03/95-12/97		DSN579	12	1.4
156 (97-06)									
1.6 16V T.Spark	Petrol	88	AR 32102;AR 32103; AR 32104;AR 67601		09/97-03/03		DSN579	12	1.4
1.8 16V T.Spark	Petrol	103	AR 32205	MTM	02/97-03/03		DSN579	12	1.4
1.8 16V T.Spark	Petrol	106	AR 32201		09/97-10/00		DSN579	12	1.4
1.9 JTD	Diesel	77	AR 32302		05/00-10/00		DSN579	12	1.4
1.9 JTD	Diesel	77/81/ 85/93/ 100/110	192 B1.000;937 A2.000; 937 A4.000;937 A5.000; AR 32302;AR 37101		09/97-05/06		DSN3018	12	2
1.9 JTD 16V	Diesel	103	192 A5.000		11/02-05/06		DSN3018	12	2
1.9 JTD 16V Q4	Diesel	110	937 A5.000		07/04-05/06		DSN3018	12	2
2.0 16V T.Spark	Petrol	110/114	AR 32301;AR 32310	MTM	05/00-06/02		DSN579	12	1.4
2.0 16V T.Spark	Petrol	114	AR 32301;AR 32310		09/97-06/02		DSN579	12	1.4
2.0 JTS	Petrol	119	932 A2.000		03/01-09/05		DSN579	12	1.4
2.0 JTS	Petrol	119/122	932 A2.000;937 A1.000	MTM	03/02-03/03		DSN579	12	1.4
2.4 JTD	Diesel	103/110/ 120/129	839 A6.000;841 C000; 841 G.000;841 M.000; 841 N.000		10/00-05/06		DSN3018	12	2
159 (05-11)									
1.9 JTDM 16V	Diesel	100/110	937 A8.000;939 A2.000; 939 A8.000		09/05-11/11		DSN3018	12	2
1.9 JTDM 8V	Diesel	85/88	937 A7.000;939 A1.000; 939 A7.000		09/05-11/11		DSN3018	12	2
2.4 JTDM	Diesel	147/154	939 A3.000;939 A9.000		09/05-12/12		DSN3018	12	2
2.4 JTDM Q4	Diesel	154	939 A9.000		05/07-11/11		DSN3018	12	2
166 (98-07)									
2.0 T.Spark	Petrol	110/114	AR 34103;AR 36301		09/98-04/06		DSN579	12	1.4
2.4 JTD	Diesel	103/110/ 120/129/ 132/136	839 A6.000;841 C000; 841 G.000;841 H.000; 841 M.000;841 N.000; 936 B.000		10/00-06/07		DSN3018	12	2
BRERA (06-10)									
2.4 JTDM 20V	Diesel	147/154	939 A3.000;939 A9.000		01/06-03/11		DSN3018	12	2
GT (03-10)									
1.8 T.Spark	Petrol	103	AR 32205	MTM	11/03-09/10		DSN579	12	1.4
1.9 JTD	Diesel	110/125	937 A5.000;937 A6.000		11/03-09/10		DSN3018	12	2
2.0 JTS	Petrol	119/121	932 A2.000;937 A1.000		11/03-09/10		DSN579	12	1.4
GTV (95-05)									
1.8 16V	Petrol	106	AR 32201		05/98-02/03		DSN579	12	1.4
2.0 JTS	Petrol	121	937 A1.000		04/03-10/05		DSN579	12	1.4
2.0 T.Spark 16V	Petrol	110	AR 16201;AR 32310		06/95-10/04	Ch No: 6001359>	DSN579	12	1.4
2.0 T.Spark 16V	Petrol	114	AR 32301		09/97-03/03		DSN579	12	1.4
MITO (08-)									
0.9 TwinAir	Petrol	63	312 A2.000		07/11-	BO	DSN975	12	1.4

									
ALFA ROMEO continued									
MITO (08-) continued									
1.4	Petrol	58	350 A1.000		03/11-		DSN3018	12	2
1.6 JTDM	Diesel	85/88	198 A2.000;955 A3.000; 955 A4.000		08/08-	- SS	DSN3018	12	2
SPIDER (94-05)									
1.8 16V	Petrol	106	AR 32201		05/98-02/03		DSN579	12	1.4
2.0 JTS	Petrol	121	937 A1.000		04/03-04/05		DSN579	12	1.4
2.0 T.Spark 16V	Petrol	110	AR 16201;AR 32310		06/95-04/05	Ch No: 6001359>	DSN579	12	1.4
2.0 T.Spark 16V	Petrol	114	AR 32301		05/98-08/00		DSN579	12	1.4
SPIDER (06-10)									
2.4 JTDM	Diesel	147/154	939 A3.000		03/06-03/11		DSN3018	12	2
AUDI									
80 (89, 8A, B3) (86-91)									
1.6 D	Diesel	40	CY;JK		02/87-07/89		DSN3015	12	1.8
1.6 TD	Diesel	59	CY;JK		09/86-08/91		DSN3015	12	1.8
1.9 D	Diesel	50	1Y		08/89-08/91	Ch No: WAUZZZ89ZH-300001 >>>	DSN3015	12	1.8
80 (8C, B4) (91-96)									
1.9 TD	Diesel	55	1Y;SB		09/91-12/94		DSN3015	12	1.8
1.9 TDI	Diesel	66	1Z		09/91-01/96		DSN3015	12	1.8
90 (89, 8A, B3) (87-91)									
1.6 TD	Diesel	59	CY;JK		04/87-09/91		DSN3015	12	1.8
A1 (8X) (10-18)									
1.0 TFSI	Petrol	60/70	CHZB;CHZE;DKLD	MTM	03/15-10/18	+ SS	DSN1468	12	1.5
1.0 TFSI	Petrol	70	CHZB;DKLD	ATM	03/15-10/18	+ SS	DSN1465	12	1.5
1.2 TFSI	Petrol	63	CBZA		05/10-04/15	- SS	DSN3006	12	1
1.4 TDI	Diesel	66	CUSB	ATM	11/14-10/18	BO;VA;+ SS	DSN1463	12	2.0
1.4 TDI	Diesel	66	CUSB	MTM	11/14-10/18	BO;VA;+ SS	DSN1462	12	2.0
1.4 TFSI	Petrol	90/92	CAXA;CNVA;CZCA; CZDD	ATM	03/13-10/18	+ SS	DSN1465	12	1.5
1.4 TFSI	Petrol	92	CZCA	MTM	11/14-10/18	+ SS	DSN1468	12	1.5
1.4 TFSI	Petrol	103	CPTA	MTM	04/12-04/15		DSN962	12	2.0
1.4 TFSI	Petrol	103	CPTA	ATM	03/13-04/15		DSN1465	12	1.5
1.4 TSI	Petrol	110	CZEA	ATM	11/14-10/18	+ SS	DSN1465	12	1.5
1.4 TSI	Petrol	110	CZEA	MTM	11/14-10/18	+ SS	DSN1468	12	1.5
1.6 TDI	Diesel	66/77	CAYB;CAYC	MTM	05/10-04/15	BO;VA;- SS	DSN963	12	2.0
1.6 TDI	Diesel	66/77/85	CAYB;CAYC;CXMA	MTM	05/10-10/18	BO;VA;+ SS	DSN1462	12	2.0
1.6 TDI	Diesel	85	CXMA	ATM	11/14-10/18	BO;VA;+ SS	DSN1463	12	2.0
1.8 TFSI	Petrol	141	DAJB	ATM	02/15-10/18	+ SS	DSN1465	12	1.5
2.0 S1 quattro	Petrol	170	CWZA	MTM	03/14-10/18	BO;+ SS	DSN1468	12	1.5
2.0 TDI	Diesel	100/105	CFHB;CFHD	MTM	09/11-04/15	BO;VA;+ SS	DSN1461	12	2.0
2.0 TFSI quattro	Petrol	188	CDLH		03/12-11/12		DSN3005	12	1.1
A1 (GB) (18-)									
1.0 30 TFSI	Petrol	85	DKJA;DKRF		07/18-	+ SS	DSN1466	12	1.5
1.5 35 TFSI	Petrol	110	DADA;DPCA		09/18-	MY: >2016;+ SS	DSN1462	12	2.0
A3 (8L) (96-03)									
1.8 T	Petrol	110	AGU;AQA;AUM	5ATM	09/00-05/03	HI	DSN957	12	1.4
1.8 T	Petrol	132	ARY;AUQ	ATM	09/00-05/03	HI	DSN957	12	1.4
1.8 T quattro	Petrol	110/132	AGU;AQA;ARX;ARY	ATM	09/00-05/03	HI	DSN957	12	1.4
1.9 TDI	Diesel	74/96	ASZ;ATD;AXR	ATM	08/00-05/03	HI	DSN958	12	2.4
1.9 TDI quattro	Diesel	96	ASZ	ATM	08/00-05/03	HI	DSN958	12	2.4
A3 (8P) (03-13)									
1.2 TSI	Petrol	77	CBZB	MTM	04/10-03/13	+ SS	DSN964	12	2.0
1.2 TSI	Petrol	77	CBZB	MTM	04/10-03/13	BO;+ SS	DSN1467	12	2.0
1.4 TFSI	Petrol	92	CAXC	MTM	09/07-03/13		DSN1463	12	2.0
1.6	Petrol	75	BGU;BSE;BSF		05/03-03/13		DSN3005	12	1.1
1.6 FSI	Petrol	85	BAG;BLF;BLP		08/03-09/07		DSN3006	12	1
1.6 TDI	Diesel	66/77	CAYB;CAYC	MTM	05/09-03/13	BO;VA;- SS	DSN963	12	2.0
1.6 TDI	Diesel	66/77	CAYB;CAYC	MTM	05/09-03/13	BO;VA;+ SS	DSN1462	12	2.0
1.6 TDI	Diesel	77	CAYC	ATM	11/09-03/13	BO;VA;+ SS	DSN1463	12	2.0
1.9 TDI	Diesel	77	BKC;BLS;BXE		05/03-05/10		DSN3006	12	1
1.9 TDI	Diesel	77	BKC;BLS;BXE		09/04-05/10		DSN3007	12	1.7
2.0 FSI	Petrol	110	AXW;BLR;BLX;BLY; BMB;BVY;BVZ		05/03-06/08		DSN3005	12	1.1
2.0 S3 quattro	Petrol	188/195	BHZ;BZC;CDLC		11/06-03/13		DSN3005	12	1.1
2.0 TDI	Diesel	100/103/ 125	AZV;BKD;BMN	MTM	05/09-08/12	BO;VA	DSN3008	12	1.7
2.0 TDI	Diesel	100/103/ 125	AZV;BKD;BMN		05/09-03/13	BO;VA	DSN3008	12	1.7

									
AUDI continued									
A3 (8P) (03-13) continued									
2.0 TDI	Diesel	100/103/125	CBAA;CBAB;CBBB;CFFA;CFFB;CFGB;CLJA	MTM	05/09-03/13	BO;VA;+ SS	DSN1461	12	2.0
2.0 TDI	Diesel	100/103/125	CFFA;CFFB;CFGB;CLJA	ATM	05/09-03/13	BO;VA;+ SS	DSN1460	12	2.0
2.0 TDI	Diesel	120	BUY		06/06-06/08		DSN3008	12	1.7
2.0 TDI 8V	Diesel	103	BMM		06/05-06/08		DSN3008	12	1.7
2.0 TDI 8V quattro	Diesel	103	BMM		01/06-06/08		DSN3008	12	1.7
2.0 TDI quattro	Diesel	100/125	AZV;BMN		05/03-03/13		DSN3008	12	1.7
2.0 TDI quattro	Diesel	103	CFFB	MTM	08/04-03/13	BO;VA;+ SS	DSN1461	12	2.0
2.0 TFSI	Petrol	147	AXX;BPY;BWA		09/04-03/13		DSN3005	12	1.1
2.0 TFSI quattro	Petrol	147	AXX;BPY;BWA		09/04-03/13		DSN3005	12	1.1
A3 (8V) (12-)									
1.0 TFSI	Petrol	85	CHZD;DKRF	ATM	07/16-	+ SS	DSN1465	12	1.5
1.0 TFSI	Petrol	85	CHZD;DKRF	MTM	07/16-	+ SS	DSN1466	12	1.5
1.2 TFSI	Petrol	77	CJZA	ATM	02/13-	BO;+ SS	DSN1465	12	1.5
1.2 TFSI	Petrol	77/81	CJZA;CYVB	MTM	02/13-	BO;+ SS	DSN1467	12	2.0
1.2 TFSI	Petrol	81	CYVB	ATM	05/14-	+ SS	DSN1465	12	1.5
1.4 TFSI	Petrol	90/92/103	CMBA;CPTA;CXSA;CXSB;CZCA	ATM	04/12-	BO;+ SS	DSN1465	12	1.5
1.4 TFSI g-tron	Petrol/ Compressed Natural Gas (CNG)	81	CPWA	ATM	11/13-	BO;+ SS	DSN1465	12	1.5
1.4 TSI	Petrol	110	CZEA	ATM	05/14-	BO;+ SS	DSN1465	12	1.5
1.5 TFSI	Petrol	110	DADA	ATM	05/17-	BO;+ SS	DSN1465	12	1.5
1.5 TFSI	Petrol	110	DADA	MTM	05/17-	BO;+ SS	DSN1468	12	1.5
1.6 TDI	Diesel	77/81/85	CLHA;CRKB;CXXB;DBKA;DDYA;DGTE	MTM	10/12-	BO;VA;+ SS	DSN1462	12	2.0
1.6 TDI	Diesel	77/81/85	CLHA;CRKB;CXXB;DDYA;DGTE	ATM	10/12-	BO;VA;+ SS	DSN1463	12	2.0
1.6 TDI quattro	Diesel	81	CXXB	ATM	05/15-	BO;VA;+ SS	DSN1463	12	2.0
1.6 TDI quattro	Diesel	81	CXXB	MTM	05/15-	BO;VA;+ SS	DSN1462	12	2.0
1.8 TFSI	Petrol	132	CJSA;CJSB	6ATM	04/12-	BO;+ SS	DSN1464	12	1.5
1.8 TFSI	Petrol	132	CJSA;CJSB	Automatic Transmission, 7-speed	04/12-	BO;+ SS	DSN1465	12	1.5
1.8 TFSI quattro	Petrol	132	CJSB	ATM	08/12-	BO;+ SS	DSN1464	12	1.5
2.0 S3 quattro	Petrol	206/210/213/221/228	CJXB;CJXC;CJXD;CJXF;CJXG;DJHA;DJHB;DNUE	MTM	11/12-	BO;+ SS	DSN1468	12	1.5
2.0 S3 quattro	Petrol	206/210/213/221/228	CJXB;CJXC;CJXF;DJHA;DJHB;DNUE	ATM	11/12-	BO;+ SS	DSN1464	12	1.5
2.0 TDI	Diesel	81/100/105/110/135	CRBC;CRBD;CRFA;CRFC;CRLB;CRLC;CRUA;CUNA;DBGA;DCYA;DEJA;DEJB;DFGA	ATM	04/12-	BO;VA;+ SS	DSN1460	12	2.0
2.0 TDI	Diesel	81/100/110/135	CRBC;CRBD;CRFA;CRLB;CRLC;CUNA;DCYA	MTM	04/12-	BO;VA;+ SS	DSN1461	12	2.0
2.0 TDI quattro	Diesel	110/135	CRBC;CRLB;CUNA;DCYA;DGCA	ATM	10/12-	BO;VA;+ SS	DSN1460	12	2.0
2.0 TDI quattro	Diesel	110/135	CRBC;CRLB;CUNA;DCYA;DGCA	MTM	10/12-	BO;VA;+ SS	DSN1461	12	2.0
2.0 TFSI	Petrol	140	CZPB;DKZA	ATM	05/16-	BO;+ SS	DSN1464	12	1.5
2.0 TFSI	Petrol	140	CZPB;DKZA	MTM	05/16-	BO;+ SS	DSN1468	12	1.5
2.0 TFSI quattro	Petrol	140	CZPB;DKZA	ATM	05/16-	BO;+ SS	DSN1464	12	1.5
2.0 TFSI quattro	Petrol	140	CZPB;DKZA	MTM	05/16-	BO;+ SS	DSN1468	12	1.5
2.5 RS3 quattro	Petrol	270/294	CZGB;DAZA;DNWA	ATM	03/15-		DSN1464	12	1.5
A3 Convertible (8P7) (08-13)									
1.2 TFSI	Petrol	77	CBZB	MTM	03/10-05/13	+ SS	DSN964	12	2.0
1.2 TFSI	Petrol	77	CBZB	MTM	03/10-05/13	BO;+ SS	DSN1467	12	2.0
1.6 TDI	Diesel	77	CAYC	MTM	11/09-05/13	BO;VA;- SS	DSN963	12	2.0
1.6 TDI	Diesel	77	CAYC	MTM	11/09-05/13	BO;VA;+ SS	DSN1462	12	2.0
1.9 TDI	Diesel	77	BLS		04/08-10/09		DSN3007	12	1.7
2.0 TDI	Diesel	100/103	CFFA;CFFB	ATM	04/08-05/13	BO;VA;+ SS	DSN1460	12	2.0
2.0 TDI	Diesel	100/103	CFFA;CFFB	MTM	04/08-05/13	BO;VA;+ SS	DSN1461	12	2.0

Starters & Alternators

Application Tables - Starters

									
AUDI continued									
A3 Convertible (8P7) (08-13) continued									
2.0 TFSI	Petrol	147	CAWB;CCZA		04/08-05/13		DSN3005	12	1.1
A3 Convertible (8V7) (13-)									
1.4 TFSI	Petrol	85	CZCC	Automatic Transmission, 7-speed	02/16-	MY: 2016>;+ SS	DSN1465	12	1.5
1.4 TFSI	Petrol	92/103	CPTA;CXSB;CZCA	ATM	10/13-	BO;+ SS	DSN1465	12	1.5
1.4 TSI	Petrol	110	CZEA	ATM	05/14-	BO;+ SS	DSN1465	12	1.5
1.5 TFSI	Petrol	110	DADA	ATM	05/17-10/18	BO;+ SS	DSN1465	12	1.5
1.5 TFSI	Petrol	110	DADA	MTM	05/17-10/18	BO;+ SS	DSN1468	12	1.5
1.6 TDI	Diesel	81/85	CRKB;CXXB;DDYA	MTM	02/14-	BO;VA;+ SS	DSN1462	12	2.0
1.8 TFSI	Petrol	132	CJSA;CJSB	6ATM	10/13-07/16	BO;+ SS	DSN1464	12	1.5
1.8 TFSI	Petrol	132	CJSA;CJSB	Automatic Transmission, 7-speed	10/13-07/16	BO;+ SS	DSN1465	12	1.5
1.8 TFSI quattro	Petrol	132	CJSB	ATM	03/14-	BO;+ SS	DSN1464	12	1.5
2.0 S3 quattro	Petrol	210/221	CJXC;CJXF;DNUE	MTM	03/14-	BO;+ SS	DSN1468	12	1.5
2.0 S3 quattro	Petrol	210/221/228	CJXC;CJXF;DJHA;DNUE	ATM	03/14-	BO;+ SS	DSN1464	12	1.5
2.0 TDI	Diesel	100/110/135	CRLB;CRLC;CUNA;DCYA;DGCA	ATM	10/13-	BO;VA;+ SS	DSN1460	12	2.0
2.0 TDI	Diesel	100/110/135	CRLB;CRLC;CUNA;DCYA;DGCA	MTM	10/13-	BO;VA;+ SS	DSN1461	12	2.0
2.0 TDI quattro	Diesel	110/135	CRLB;CUNA;DCYA;DGCA	ATM	03/14-	BO;VA;+ SS	DSN1460	12	2.0
2.0 TDI quattro	Diesel	110/135	CRLB;CUNA;DCYA;DGCA	MTM	03/14-	BO;VA;+ SS	DSN1461	12	2.0
2.0 TFSI	Petrol	140	CZPB	ATM	05/16-	BO;+ SS	DSN1464	12	1.5
2.0 TFSI	Petrol	140	CZPB	MTM	05/16-	BO;+ SS	DSN1468	12	1.5
2.0 TFSI quattro	Petrol	140	CZPB	MTM	05/16-	BO;+ SS	DSN1468	12	1.5
2.0 TFSI quattro	Petrol	140/162	CNTC;CZPB	ATM	05/14-	BO;+ SS	DSN1464	12	1.5
A4 (8D, B5) (94-01)									
1.9 Hybrid	Diesel/Electro	66	AHU		03/98-06/00		DSN3015	12	1.8
1.9 TDI	Diesel	55/66/81/85	1Z;AFF;AFN;AHH;AHU;AJM;ATJ		01/95-09/01		DSN3015	12	1.8
1.9 TDI quattro	Diesel	81	AFN		09/96-09/01		DSN3015	12	1.8
1.9 TDI quattro	Diesel	85	AJM	ATM	03/00-09/01		DSN3015	12	1.8
A4 (8E, B6) (00-04)									
1.6	Petrol	75	ALZ	MTM	11/00-12/04		DSN3015	12	1.8
1.9 TDI	Diesel	74/85/96	AVB;AVF;BKE		11/00-12/04		DSN3015	12	1.8
2.0	Petrol	96	ALT	ATM	11/00-12/04		DSN3015	12	1.8
3.0	Petrol	162	ASN		09/01-12/04		DSN3015	12	1.8
A4 (8E, B7) (04-08)									
1.9 TDI	Diesel	85	BKE;BRB		11/04-06/08		DSN3015	12	1.8
A4 (8K, B8) (07-15)									
1.8 TFSI	Petrol	88/125	CDHA;CJEB		01/08-12/15	BO;+ SS	DSN1201	12	1.5
1.8 TFSI quattro	Petrol	125	CJEB		11/11-12/15	BO;+ SS	DSN1201	12	1.5
2.0 TDI	Diesel	88/100/105/110/120/125/130	CAGA;CAGB;CAGC;CAHA;CAHB;CGLC;CGLD;CJCA;CJCB;CJCC;CJCD;CMEA;CMFA;CMFB;CMGB;CNHC;CSUB		11/07-12/15	BO;VA;-/+ SS	DSN994	12	1.8
2.0 TDI quattro	Diesel	105/110/125/130	CAGA;CAHA;CGLC;CJCA;CJCD		01/08-12/15	BO;VA;-/+ SS	DSN994	12	1.8
2.0 TFSI	Petrol	132/155/165	CAEA;CAEB;CDNB;CDNC;CFKA;CNCD		06/08-12/15	BO;+ SS	DSN1201	12	1.5
2.0 TFSI FlexFuel	Flexfuel	132	CFKA		11/09-12/15	BO;+ SS	DSN1201	12	1.5
2.0 TFSI FlexFuel quattro	Flexfuel	132	CFKA		11/09-12/15	BO;+ SS	DSN1201	12	1.5
2.0 TFSI quattro	Petrol	155/162/165	CAEB;CAED;CDNC;CNCD;CPMA;CPMB		06/08-12/15	BO;+ SS	DSN1201	12	1.5
3.0 S4 quattro	Petrol	245	CGWC;CGXC;CTUB		11/11-12/15	BO;+ SS	DSN1204	12	1.7
3.0 TDI	Diesel	150	CLAB		11/11-12/15	BO;+ SS	DSN1203	12	1.9
3.0 TDI quattro	Diesel	180	CDUC;CKVB;CKVC		11/11-12/15	BO;+ SS	DSN1203	12	1.9
3.0 TFSI quattro	Petrol	200	CMUA;CRED		02/12-12/15	BO;+ SS	DSN1204	12	1.7
A4 Allroad (8KH) (09-16)									
2.0 TDI quattro	Diesel	100/105/120/125/130	CAGA;CAGB;CAHA;CAHB;CGLC;CGLD;CJCA;CJCB;CNHC;CSUB		04/09-05/16	BO;VA;-/+ SS	DSN994	12	1.8













kW

AUDI continued										
A4 Allroad (8KH) (09-16) continued										
2.0 TDI quattro	Diesel	110	CJCD;CSUA		05/13-05/16	Eng No: CJCD>; MY: 2013>	DSN994	12	1.8	
2.0 TFSI quattro	Petrol	155/162/ 165	CDNC;CNCD;CPMA; CPMB		04/09-05/16	BO;+ SS	DSN1201	12	1.5	
3.0 TDI quattro	Diesel	180	CDUC;CKVB;CKVC		01/12-05/16	BO;+ SS	DSN1203	12	1.9	
A4 Convertible (8H, B6, B7) (02-09)										
3.0	Petrol	162	ASN;AVK;BGN		04/02-12/05		DSN3015	12	1.8	
3.0 quattro	Petrol	162	ASN;AVK;BGN		05/03-12/05		DSN3015	12	1.8	
A5 (8T, 8F) (07-17)										
1.8 TFSI	Petrol	125	CJEB		10/07-01/17	BO;+ SS	DSN1201	12	1.5	
1.8 TFSI	Petrol	130	CJEE		05/15-01/17	+ SS	DSN1201	12	1.5	
2.0 TDI	Diesel	100/105/ 120/125/ 130	CAGA;CAGB;CAHA; CAHB;CGLC;CGLD; CJCA;CJCB;CMEA; CMFA;CNHC;CSUB		08/08-01/17	BO;VA;-/+ SS	DSN994	12	1.8	
2.0 TDI	Diesel	110	CJCD;CMFB;CSUA		05/13-01/17	Eng No: >CJCD; MY: 2013>	DSN994	12	1.8	
2.0 TDI quattro	Diesel	125/130	CAHA;CGLC		08/08-01/17	BO;VA;-/+ SS	DSN994	12	1.8	
2.0 TFSI	Petrol	132/155/ 162/165	CAEA;CAEB;CAED; CDNB;CDNC;CNCD		06/08-05/16	BO;+ SS	DSN1201	12	1.5	
2.0 TFSI quattro	Petrol	155/162/ 165	CAEB;CAED;CDNC; CNCD;CPMA		06/08-01/17	BO;+ SS	DSN1201	12	1.5	
3.0 S4 quattro	Petrol	245	CGWC;CGXC;CTUB		09/11-01/17	BO;+ SS	DSN1204	12	1.7	
3.0 TDI	Diesel	150	CLAB		10/11-01/17	BO;+ SS	DSN1203	12	1.9	
3.0 TDI quattro	Diesel	160	CKVD		05/15-01/17	MY: 2013>;+ SS	DSN1203	12	1.9	
3.0 TDI quattro	Diesel	180	CDUC;CKVB;CKVC		10/11-01/17	BO;+ SS	DSN1203	12	1.9	
3.0 TFSI quattro	Petrol	200	CHMB;CMUA;CRED		11/11-01/17	BO;+ SS	DSN1204	12	1.7	
A6 (4A, C4) (94-97)										
1.9 TDI	Diesel	66	1Z;AHU		06/94-12/97		DSN3015	12	1.8	
A6 (4B, C5) (97-05)										
1.9 TDI	Diesel	81/85/96	AFN;AJM;AVF;AVG		04/97-01/05		DSN3015	12	1.8	
A6 (4G, C7) (10-18)										
2.0 TDI	Diesel	100/120/ 130	CGLC;CGLD;CGLI; CMGB;CSUE;DDCA		03/11-09/18	BO;VA;-/+ SS	DSN994	12	1.8	
2.0 TFSI	Petrol	132/155	CAEB;CDNB		03/11-09/18	BO;+ SS	DSN1201	12	1.5	
2.0 TFSI hybrid	Petrol/ Electric	155	CHJA		11/11-09/18		DSN1201	12	1.5	
2.0 TFSI quattro	Petrol	155	CAEB		05/12-05/13	BO;+ SS	DSN1201	12	1.5	
2.8 FSI	Petrol	150	CHVA		11/10-04/15	BO;+ SS	DSN1204	12	1.7	
2.8 FSI quattro	Petrol	150	CHVA		11/10-04/15	BO;+ SS	DSN1204	12	1.7	
3.0 TDI	Diesel	150	CLAB		11/10-09/18	BO;+ SS	DSN1203	12	1.9	
3.0 TDI	Diesel	155	CZVD		09/14-09/18	+ SS	DSN1203	12	1.9	
3.0 TDI quattro	Diesel	150/180/ 230	CDUC;CDUD;CGQB; CKVB;CKVC;CLAA		03/11-09/18	BO;+ SS	DSN1203	12	1.9	
3.0 TDI quattro	Diesel	160/200/ 240	CRTD;CVUB;CZVA		09/14-09/18	+ SS	DSN1203	12	1.9	
3.0 TFSI quattro	Petrol	220/228	CCAA;CGWB;CGWD; CGXB;CTUA		11/10-09/18	BO;+ SS	DSN1204	12	1.7	
4.0 RS6 quattro	Petrol	412	CRDB;CWUB		01/13-09/18	BO;+ SS	DSN1204	12	1.7	
4.0 S6 quattro	Petrol	309	CEUC		02/12-09/18	BO;+ SS	DSN1204	12	1.7	
4.0 S6 quattro	Petrol	331	CTGE		10/14-09/18	MY: 2014>;+ SS	DSN1204	12	1.7	
A6 Allroad (4GH) (12-18)										
3.0 TDI quattro	Diesel	150/180/ 230	CDUD;CGQB;CKVC; CLAA		01/12-06/16	BO;+ SS	DSN1203	12	1.9	
3.0 TFSI quattro	Petrol	228	CGWD		01/12-12/14	BO;+ SS	DSN1204	12	1.7	
A7 (4GA) (10-18)										
2.8 FSI	Petrol	150	CHVA		02/11-03/15	BO;+ SS	DSN1204	12	1.7	
2.8 FSI quattro	Petrol	150	CHVA;CNVA		10/10-03/15	BO;+ SS	DSN1204	12	1.7	
3.0 TDI	Diesel	150	CLAB		11/10-03/15	BO;+ SS	DSN1203	12	1.9	
3.0 TDI quattro	Diesel	150/176/ 180/230	CDUC;CDUD;CGQB; CKVB;CKVC;CLAA; CPNB		10/10-06/17	BO;+ SS	DSN1203	12	1.9	
3.0 TFSI quattro	Petrol	220/228	CGWB;CGWD;CGXB; CHMA;CTTA;CTUA		10/10-03/15	BO;+ SS	DSN1204	12	1.7	
4.0 RS7 quattro	Petrol	412	CRDB;CWUB		10/13-04/18	BO;+ SS	DSN1204	12	1.7	
4.0 S7 quattro	Petrol	309	CEUC		02/12-03/15	BO;+ SS	DSN1204	12	1.7	
A8 (4H) (09-18)										
2.0 TFSI hybrid	Petrol/ Electric	155	CHJA		02/12-11/15		DSN1201	12	1.5	
2.5 TFSI	Petrol	150	CPAA;CVBA		07/12-06/16	BO;+ SS	DSN1204	12	1.7	
3.0 TDI	Diesel	150	CLAB		09/11-09/13	BO;+ SS	DSN1203	12	1.9	
3.0 TDI quattro	Diesel	155/176/ 184/190	CDTA;CDTB;CDTC; CMHA;CPNA;CPNB; CTBA;CTBB		07/10-01/18	BO;+ SS	DSN1203	12	1.9	

Starters & Alternators











Application Tables - Starters











									
AUDI continued									
A8 (4H) (09-18) continued									
3.0 TDI quattro	Diesel	193	CTBD		05/15-01/18	+ SS	DSN1203	12	1.9
3.0 TFSI quattro	Petrol	213/228/245	CGWA;CGWD;CGXA;CGXC;CMDA;CREA;CREC;CREG;CTDA;CTUB		06/10-01/18	BO;+ SS	DSN1204	12	1.7
4.0 S8 plus quattro	Petrol	445	DDTA		11/15-01/18	MY: 2014>;+ SS	DSN1204	12	1.7
4.0 S8 quattro	Petrol	382	CGTA;CTFA		04/12-01/18	BO;+ SS	DSN1204	12	1.7
4.0 TFSI quattro	Petrol	309/320	CEUA;CTGA		03/12-12/15	BO;+ SS	DSN1204	12	1.7
4.2 TDI quattro	Diesel	258/283	CDSB;CTEC		11/09-01/18	BO;+ SS	DSN1203	12	1.9
CABRIOLET (8G7) (91-00)									
1.9 TDI	Diesel	66	1Z;AHU		06/95-08/00		DSN3015	12	1.8
Q2 (GAB) (16-)									
1.0 30 TFSI	Petrol	85	DKRF		07/18-	+ SS	DSN1466	12	1.5
1.0 TFSI	Petrol	85	CHZJ	ATM	10/16-	+ SS	DSN1465	12	1.5
1.0 TFSI	Petrol	85	CHZJ	MTM	10/16-	+ SS	DSN1466	12	1.5
1.4 TFSI	Petrol	110	CZEA	MTM	06/16-		DSN1460	12	2.0
1.5 35 TFSI	Petrol	110	DADA;DPCA		07/18-	MY: >2016;+ SS	DSN1462	12	2.0
1.6 TDI	Diesel	85	DDYA	ATM	06/16-10/18	BO;VA;+ SS	DSN1463	12	2.0
1.6 TDI	Diesel	85	DDYA	MTM	06/16-10/18	BO;VA;+ SS	DSN1462	12	2.0
2.0 TDI	Diesel	110	DFGA	ATM	09/16-	BO;VA;+ SS	DSN1460	12	2.0
2.0 TDI	Diesel	110	DFGA	MTM	09/16-	BO;VA;+ SS	DSN1461	12	2.0
2.0 TDI quattro	Diesel	110/140	DFGA;DFHA	ATM	07/16-	BO;VA;+ SS	DSN1460	12	2.0
2.0 TDI quattro	Diesel	110/140	DFGA;DFHA	MTM	07/16-	BO;VA;+ SS	DSN1461	12	2.0
Q3 (8U) (11-18)									
1.4 TFSI	Petrol	92	CZDB	MTM	07/16-10/18	BO;+ SS	DSN1468	12	1.5
1.4 TSI	Petrol	110	CHPB;CZDA;CZEA	ATM	10/13-10/18	BO;+ SS	DSN1465	12	1.5
1.4 TSI	Petrol	110	CHPB;CZDA;CZEA	MTM	10/13-10/18	BO;+ SS	DSN1468	12	1.5
2.0 TDI	Diesel	88/100/103/110/130/135	CFFA;CFFB;CFGC;CLJA;CUVB;CUVC;CUVD;CUWA;DFTA;DFTB;DFTC;DFUA	MTM	06/11-10/18	BO;VA;+ SS	DSN1461	12	2.0
2.0 TDI	Diesel	88/103/110/130/135	CFFB;CFGC;CUVC;CUWA;DFTA;DFTC	ATM	06/11-10/18	BO;VA;+ SS	DSN1460	12	2.0
2.0 TDI quattro	Diesel	103/110/120/130/135	CFFB;CFGC;CFGD;CLLB;CUVC;CUWA;DFTA	ATM	06/11-10/18	BO;VA;+ SS	DSN1460	12	2.0
2.0 TDI quattro	Diesel	103/110/130/135	CFFB;CFGC;CUVC;CUWA;DFTA;DFUA	MTM	06/11-10/18	BO;VA;+ SS	DSN1461	12	2.0
2.0 TFSI	Petrol	132	CULB	ATM	05/15-10/18	BO;+ SS	DSN1465	12	1.5
2.0 TFSI	Petrol	132	CULB	MTM	05/15-10/18	BO;+ SS	DSN1468	12	1.5
2.0 TFSI quattro	Petrol	125	CCZC	MTM	06/11-12/12	+ SS	DSN962	12	2.0
2.0 TFSI quattro	Petrol	125	CCZC		06/11-04/15	BO;VA;- SS	DSN3005	12	1.1
2.0 TFSI quattro	Petrol	125/132	CCZC;CULB	MTM	12/12-10/18	BO;+ SS	DSN1468	12	1.5
2.0 TFSI quattro	Petrol	125/132/155/162	CCZC;CPSA;CULB;CULC	ATM	06/11-10/18	BO;+ SS	DSN1465	12	1.5
2.5 RS quattro	Petrol	228/250/270	CTSA;CZGA;CZGB	ATM	05/13-10/18		DSN1464	12	1.5
Q3 (F3) (18-)									
1.5 35 TFSI	Petrol	110	DADA;DPCA		08/18-	MY: >2016;+ SS	DSN1462	12	2.0
Q5 (8R) (08-17)									
2.0 TDI	Diesel	100/105	CJCA;CJCB;CSUB		11/10-05/17	BO;VA;-/+ SS	DSN994	12	1.8
2.0 TDI	Diesel	110	CJCD	MTM	05/13-05/17		DSN994	12	1.8
2.0 TDI quattro	Diesel	100/105/120/125/130	CAGA;CAGB;CAHA;CAHB;CGLA;CGLB;CGLC;CGLD;CJCA;CJCB;CMGA;CMGB;CNHC;CSUB		11/08-05/17	BO;VA;-/+ SS	DSN994	12	1.8
2.0 TDI quattro	Diesel	110	CJCD;CSUA		05/13-05/17	Eng No: CJCD>; MY: 2013>	DSN994	12	1.8
2.0 TFSI Hybrid quattro	Petrol/ Electric	155	CHJA		06/11-06/16		DSN1201	12	1.5
2.0 TFSI quattro	Petrol	132/155/165	CAEB;CNCB;CNCD		11/08-05/17	BO;+ SS	DSN1201	12	1.5
3.0 SQ5 TDI quattro	Diesel	230	CGQB;CVUC		12/12-11/15	BO;+ SS	DSN1203	12	1.9
3.0 SQ5 TDI quattro	Diesel	240	CVUB		04/15-05/17	+ SS	DSN1203	12	1.9
3.0 SQ5 TFSI quattro	Petrol	260	CTUD;CTXA		05/13-05/17	BO;+ SS	DSN1204	12	1.7
3.0 TDI quattro	Diesel	176	CPNB	ATM	11/08-05/17		DSN1203	12	1.9
3.0 TDI quattro	Diesel	180/184/190	CDUD;CTBA;CTBC		06/12-05/17	BO;+ SS	DSN1203	12	1.9
3.0 TFSI quattro	Petrol	200	CTUC;CTVA		06/12-05/17	BO;+ SS	DSN1204	12	1.7
Q7 (4L) (06-15)									
3.0 TDI quattro	Diesel	150/176/180	CJGA;CJGC;CJGD;CJMA;CLZB;CNRB;CRCA		05/10-08/15	+ SS	DSN965	12	2.0













kW

AUDI continued									
TT (8J) (06-14)									
2.0 TFSI	Petrol	147	CCTA		08/06-06/10		DSN3005	12	1.1
2.0 TFSI	Petrol	155	CESA	MTM	05/10-06/14		DSN3005	12	1.1
2.0 TTS quattro	Petrol	195/200	CDLA;CDLB		05/08-06/14		DSN3005	12	1.1
3.2 V6 quattro	Petrol	184	BUB;CBRA		08/06-06/10		DSN3008	12	1.7
TT (8N) (98-06)									
1.8 T	Petrol	120/140	BVP;BVR		09/05-06/06		DSN3008	12	1.7
1.8 T quattro	Petrol	165	APX;BAM;BEA	6ATM	10/99-06/06		DSN3008	12	1.7
TT (FV) (14-)									
1.8 TFSI	Petrol	132	CJSA	ATM	07/15-08/18		DSN1465	12	1.5
1.8 TFSI	Petrol	132	CJSA	MTM	07/15-08/18		DSN1466	12	1.5
1.8 TFSI	Petrol	132	CJSB	ATM	07/15-08/18		DSN1464	12	1.5
2.0 TDI	Diesel	135	CUNA	ATM	07/14-		DSN1460	12	2.0
2.0 TDI	Diesel	135	CUNA	MTM	07/14-		DSN1461	12	2.0
2.0 TDI quattro	Diesel	135	CUNA	ATM	01/17-		DSN1460	12	2.0
2.0 TDI quattro	Diesel	135	CUNA	MTM	01/17-		DSN1461	12	2.0
2.0 TFSI	Petrol	169	CHHC	ATM	07/14-	BO;+ SS	DSN1464	12	1.5
2.0 TFSI	Petrol	169	CHHC	MTM	07/14-	BO;+ SS	DSN1468	12	1.5
2.0 TFSI quattro	Petrol	169	CHHC	ATM	07/14-	BO;+ SS	DSN1464	12	1.5
2.0 TFSI quattro	Petrol	169	CHHC	MTM	07/14-	BO;+ SS	DSN1468	12	1.5
2.0 TTS quattro	Petrol	210/228	CJXF;CJXG	ATM	11/14-	BO;+ SS	DSN1464	12	1.5
2.0 TTS quattro	Petrol	228	CJXG	MTM	11/14-	BO;+ SS	DSN1468	12	1.5
2.5 RS quattro	Petrol	294	DAZA;DNWA	ATM	10/16-		DSN1464	12	1.5
BMW									
1 (E81, E87) (03-12)									
116 i 1.6	Petrol	90	N43 B16 AA	ATM	03/07-12/11	- SS	DSN1375	12	1.3
116 i 1.6	Petrol	90	N43 B16 AA	ATM	09/07-06/11		DSN1375	12	1.3
116 i 2.0	Petrol	90	N43 B20 A	ATM	11/08-12/11	- SS	DSN1375	12	1.3
118 i	Petrol	105	N43 B20 A	ATM	09/06-12/11	- SS	DSN1375	12	1.3
118 i	Petrol	105/125	N43 B20 A	ATM	09/06-06/11		DSN1375	12	1.3
120 i	Petrol	120/125	N43 B20 A	ATM	03/07-06/11		DSN1375	12	1.3
120 i	Petrol	120/125	N43 B20 A	ATM	03/07-09/12	- SS	DSN1375	12	1.3
130 i	Petrol	190/195	N52 B30 A;N52 B30 B		09/05-12/11		DSN1375	12	1.3
1 (F20, F21) (10-)									
M 135 i	Petrol	235/240	N55 B30 A	ATM	12/11-		DSN1376	12	1.6
M 135 xi	Petrol	235/240	N55 B30 A	ATM	02/12-		DSN1376	12	1.6
1 Coupe/Convertible (E82, E88) (07-13)									
118 i	Petrol	105	N43 B20 A	ATM	03/08-12/13		DSN1375	12	1.3
120 i	Petrol	120/125	N43 B20 A	ATM	12/07-12/13		DSN1375	12	1.3
120 i	Petrol	125	N43 B20 A	ATM	10/07-10/13	- SS	DSN1375	12	1.3
125 i	Petrol	160	N52 B30 A;N52 B30 B; N52 B30 BF		12/07-10/13		DSN1375	12	1.3
135 i	Petrol	225/240	N54 B30 A;N55 B30 A		10/07-12/13		DSN1375	12	1.3
M1 3.0	Petrol	250	N54 B30 A		03/11-06/12		DSN1375	12	1.3
2 Coupe/Convertible (F22, F23) (13-)									
M 235 i	Petrol	240	N55 B30 A		10/13-		DSN1376	12	1.6
M 235 xi	Petrol	240	N55 B30 A		07/14-		DSN1376	12	1.6
M2 3.0	Petrol	272	N55 B30 A		11/15-06/18		DSN1376	12	1.6
M2 3.0 Competition	Petrol	302	S55 B30 A		06/18-		DSN1376	12	1.6
3 (E90, E91) (05-12)									
316 i	Petrol	90	N43 B16 A;N43 B16 AA	ATM	09/07-06/12	- SS	DSN1375	12	1.3
318 i	Petrol	105	N43 B20 A	ATM	05/07-05/12	- SS	DSN1375	12	1.3
320 i	Petrol	120/125	N43 B20 A	ATM	02/07-12/12	- SS	DSN1375	12	1.3
323 i	Petrol	130/140	N52 B25 A;N52 B25 B; N52 B25 BE; N52 B25 BF		09/05-12/11		DSN1375	12	1.3
325 i 2.5	Petrol	155/160	N52 B25 A;N52 B25 B; N52 B25 BF		12/04-12/11		DSN1375	12	1.3
325 i 3.0	Petrol	155/160	N53 B30 A		03/07-06/12		DSN1375	12	1.3
325 xi 2.5	Petrol	160	N52 B25 A		08/05-08/08		DSN1375	12	1.3
325 xi 3.0	Petrol	160	N53 B30 A		09/07-06/12		DSN1375	12	1.3
330 i	Petrol	190/200	N52 B30 A;N52 B30 B; N53 B30 A		12/04-06/12		DSN1375	12	1.3
330 xi	Petrol	190/200	N52 B30 A;N53 B30 A		09/05-06/12		DSN1375	12	1.3
335 i	Petrol	225	N54 B30 A;N55 B30 A		03/06-06/12		DSN1375	12	1.3
335 i	Petrol	225	N55 B30 A		09/09-12/11	- SS	DSN1375	12	1.3
335 i	Petrol	225	N55 B30 A	ATM	09/09-12/11	+ SS	DSN1376	12	1.6
335 xi	Petrol	225	N54 B30 A;N55 B30 A		09/06-06/12		DSN1375	12	1.3
3 (F30, F31) (11-19)									
3.0 ActiveHybrid	Petrol/ Electric	225/250	N55 B30 A	MTM	07/12-06/15	- SS	DSN1375	12	1.3

									
BMW continued									
3 (F30, F31) (11-19) continued									
3.0 ActiveHybrid	Petrol/ Electric	225/250	N55 B30 A	ATM	07/12-06/15	-/+ SS	DSN1376	12	1.6
335 i	Petrol	225/240/ 250	N55 B30 A	MTM	11/11-07/15	- SS	DSN1375	12	1.3
335 i	Petrol	225/240/ 250	N55 B30 A	ATM	11/11-07/15	-/+ SS	DSN1376	12	1.6
335 xi	Petrol	225/240/ 250	N55 B30 A	MTM	07/12-07/15	- SS	DSN1375	12	1.3
335 xi	Petrol	225/240/ 250	N55 B30 A	ATM	07/12-07/15	-/+ SS	DSN1376	12	1.6
M3 3.0	Petrol	317	S55 B30 A		03/14-10/18		DSN1376	12	1.6
M3 3.0 Competition	Petrol	331	S55 B30 A		03/16-10/18		DSN1376	12	1.6
3 Coupe/Convertible (E92, E93) (06-13)									
316 i	Petrol	90	N43 B16 AA	ATM	09/07-06/13	- SS	DSN1375	12	1.3
318 i	Petrol	105	N43 B20 A	ATM	03/10-12/13	- SS	DSN1375	12	1.3
320 i	Petrol	120/125	N43 B20 A	ATM	09/06-12/13	- SS	DSN1375	12	1.3
323 i	Petrol	140	N52 B25 A		03/07-09/11		DSN1375	12	1.3
325 i 2.5	Petrol	160	N52 B25 A; N52 B25 AF; N52 B25 BF		06/06-02/10		DSN1375	12	1.3
325 i 3.0	Petrol	155/160	N53 B30 A		10/06-12/13		DSN1375	12	1.3
325 xi 2.5	Petrol	160	N52 B25 A		09/06-02/10		DSN1375	12	1.3
325 xi 3.0	Petrol	160	N53 B30 A		09/07-12/13		DSN1375	12	1.3
330 i	Petrol	190/200	N52 B30 A; N52 B30 AF; N52N B30 B;N53 B30 A		09/06-10/13		DSN1375	12	1.3
330 xi	Petrol	200	N52 B30 A;N53 B30 A		09/06-06/13		DSN1375	12	1.3
335 i	Petrol	225	N54 B30 A;N55 B30 A		06/06-10/13		DSN1375	12	1.3
335 xi	Petrol	225	N54 B30 A;N55 B30 A		03/07-12/13		DSN1375	12	1.3
3 Gran Turismo (F34) (13-)									
335 i	Petrol	225/240/ 250	N55 B30 A	MTM	03/13-06/16	- SS	DSN1375	12	1.3
335 i	Petrol	225/240/ 250	N55 B30 A	ATM	03/13-06/16	-/+ SS	DSN1376	12	1.6
335 xi	Petrol	225/240/ 250	N55 B30 A	MTM	03/13-06/16	- SS	DSN1375	12	1.3
335 xi	Petrol	225/240/ 250	N55 B30 A	ATM	03/13-06/16	-/+ SS	DSN1376	12	1.6
4 Coupe/Convertible (F32, F33) (13-)									
435 i	Petrol	225/250	N55 B30 A	MTM	07/13-02/16	- SS	DSN1375	12	1.3
435 i	Petrol	225/250	N55 B30 A	ATM	07/13-02/16	-/+ SS	DSN1376	12	1.6
435 xi	Petrol	225/250	N55 B30 A	MTM	07/13-02/16	- SS	DSN1375	12	1.3
435 xi	Petrol	225/250	N55 B30 A	ATM	07/13-02/16	-/+ SS	DSN1376	12	1.6
M4 3.0	Petrol	317	S55 B30 A		03/14-		DSN1376	12	1.6
M4 3.0 Competition	Petrol	331	S55 B30 A		03/16-		DSN1376	12	1.6
M4 3.0 GTS	Petrol	368	S55 B30 A		03/16-02/17		DSN1376	12	1.6
4 Gran Coupe (F36) (14-)									
435 i	Petrol	225/250	N55 B30 A	MTM	03/14-02/16	- SS	DSN1375	12	1.3
435 i	Petrol	225/250	N55 B30 A	ATM	03/14-02/16	-/+ SS	DSN1376	12	1.6
435 xi	Petrol	225/250	N55 B30 A	MTM	07/14-02/16	- SS	DSN1375	12	1.3
435 xi	Petrol	225/250	N55 B30 A	ATM	07/14-02/16	-/+ SS	DSN1376	12	1.6
5 (E60, E61) (03-10)									
520 i 2.0	Petrol	120/125	N43 B20 A		12/06-12/10		DSN1375	12	1.3
523 i	Petrol	130/140	N52 B25 A;N52 B25 B; N52 B25 BE;N53 B25 A		10/04-12/10		DSN1375	12	1.3
525 i 2.5	Petrol	155/160	N52 B25 A;N52 B25 B; N52 B25 BF		03/05-05/10		DSN1375	12	1.3
525 i 3.0	Petrol	155/160	N53 B30 A		01/07-12/10		DSN1375	12	1.3
525 xi	Petrol	160	N53 B30 A		09/08-12/10		DSN1375	12	1.3
525 xi 2.5	Petrol	160	N52 B25 A		04/05-12/10		DSN1375	12	1.3
525 xi 3.0	Petrol	160	N53 B30 A		01/07-12/10		DSN1375	12	1.3
530 i	Petrol	187/190/ 200	N52 B30 A;N52 B30 B; N52 B30 BF;N53 B30 A		09/04-12/10		DSN1375	12	1.3
530 xi	Petrol	190/200	N52 B30 A;N53 B30 A		09/04-05/10		DSN1375	12	1.3
5 (F10, F11) (10-16)									
3.0 ActiveHybrid	Petrol/ Electric	225/250	N55 B30 A	ATM	12/11-10/16		DSN1376	12	1.6
520 i 1.6	Petrol	125	N20 B16 A		07/13-10/16	- SS	DSN1375	12	1.3
520 i 2.0	Petrol	120/135	N20 B20 A;N20 B20 B		10/10-02/17	- SS	DSN1375	12	1.3
523 i 2.5	Petrol	150	N52 B25 A; N52 B25 AF;N52 B25 B		11/09-08/11		DSN1375	12	1.3











										
BMW continued										
5 (F10, F11) (10-16) continued										
523 i 3.0	Petrol	150	N53 B30 A		06/09-08/11			DSN1375	12	1.3
528 i 2.0	Petrol	180	N20 B20 A		09/11-02/17	- SS		DSN1375	12	1.3
528 i 3.0	Petrol	190	N53 B30 A		11/09-08/11			DSN1375	12	1.3
528 xi	Petrol	180	N20 B20 A		09/11-02/17	- SS		DSN1375	12	1.3
530 i	Petrol	200	N53 B30 A		05/11-06/13			DSN1375	12	1.3
535 i	Petrol	225	N55 B30 A		01/10-03/11			DSN1375	12	1.3
535 i	Petrol	225/240	N55 B30 A	ATM	03/11-02/17			DSN1376	12	1.6
535 xi	Petrol	225/240	N55 B30 A	ATM	03/11-02/17			DSN1376	12	1.6
550 i	Petrol	300	N63 B44 A		03/10-06/13			DSN1377	12	1.6
550 i	Petrol	300/330	N63 B44 B		10/12-02/17			DSN1378	12	1.6
550 xi	Petrol	300	N63 B44 A		08/10-06/13			DSN1377	12	1.6
550 xi	Petrol	330	N63 B44 B		07/13-10/16			DSN1378	12	1.6
M5 4.4	Petrol	412	S63 B44 B		09/11-10/16			DSN1378	12	1.6
M5 4.4 Competition	Petrol	423	S63 B44 B		02/13-10/16			DSN1378	12	1.6
M5 4.4 Edition 30	Petrol	441	S63 B44 B		07/14-10/16			DSN1378	12	1.6
5 Gran Turismo (F07) (09-17)										
528 i	Petrol	180	N20 B20 A		07/13-02/17	- SS		DSN1375	12	1.3
535 i	Petrol	225	N55 B30 A		01/09-06/13	- SS		DSN1375	12	1.3
535 i	Petrol	225	N55 B30 A		01/09-02/17	+ SS		DSN1376	12	1.6
535 xi	Petrol	225	N55 B30 A		09/10-06/13	- SS		DSN1375	12	1.3
535 xi	Petrol	225	N55 B30 A		09/10-02/17	+ SS		DSN1376	12	1.6
550 i	Petrol	300	N63 B44 A		08/09-06/12			DSN1377	12	1.6
550 i	Petrol	330	N63 B44 A;N63 B44 B		07/12-02/17			DSN1378	12	1.6
550 xi	Petrol	300	N63 B44 A		06/10-06/12			DSN1377	12	1.6
550 xi	Petrol	330	N63 B44 B		07/12-02/17			DSN1378	12	1.6
6 (E63, E64) (04-10)										
630 i	Petrol	190/200	N52 B30 A;N52 B30 B; N52 B30 BF;N53 B30 A		09/04-08/10			DSN1375	12	1.3
6 Coupe/Convertible (F12, F13) (10-18)										
640 i	Petrol	235	N55 B30 A		07/11-06/18			DSN1376	12	1.6
640 xi	Petrol	235	N55 B30 A		03/13-06/18			DSN1376	12	1.6
650 i	Petrol	298/300/ 330	N63 B44 A		12/10-06/18			DSN1377	12	1.6
650 i	Petrol	330	N63 B44 B		11/11-06/18			DSN1378	12	1.6
650 xi	Petrol	300/330	N63 B44 A		09/11-06/18			DSN1377	12	1.6
650 xi	Petrol	330	N63 B44 B		07/12-06/18			DSN1378	12	1.6
M6 4.4	Petrol	412	S63 B44 B		03/12-06/18			DSN1378	12	1.6
M6 4.4 Competition	Petrol	423/441	S63 B44 B		07/13-06/18			DSN1378	12	1.6
6 Gran Coupe (F06) (11-18)										
640 i	Petrol	235	N55 B30 A		03/12-10/18			DSN1376	12	1.6
640 xi	Petrol	235	N55 B30 A		03/13-10/18			DSN1376	12	1.6
650 i	Petrol	330	N63 B44 B		07/12-10/18			DSN1378	12	1.6
650 xi	Petrol	330	N63 B44 B		07/12-10/18			DSN1378	12	1.6
M6 4.4	Petrol	412	S63 B44 B		03/13-10/18			DSN1378	12	1.6
M6 4.4 Competition	Petrol	423/441	S63 B44 B		07/13-10/18			DSN1378	12	1.6
7 (E65, E66) (01-08)										
730 i	Petrol	190	N52 B30 A;N52 B30 BF		03/05-08/08			DSN1375	12	1.3
7 (F01, F02, F03, F04) (08-15)										
3.0 ActiveHybrid	Petrol/ Electric	235/260	N55 B30 A		08/12-06/15			DSN1375	12	1.3
730 i	Petrol	190	N52 B30 A		09/09-06/15			DSN1375	12	1.3
740 i	Petrol	235	N55 B30 A		07/12-12/15			DSN1376	12	1.6
740 i	Petrol	240	N54 B30 A		09/08-06/12			DSN1375	12	1.3
740 xi	Petrol	235	N55 B30 A		07/12-12/15			DSN1376	12	1.6
750 i, Li	Petrol	300	N63 B44 A		09/08-06/12			DSN1377	12	1.6
750 i, Li	Petrol	330	N63 B44 B		07/12-06/15			DSN1378	12	1.6
750 xi	Petrol	300	N63 B44 A		09/09-06/12			DSN1377	12	1.6
750 xi	Petrol	300/330	N63 B44 B		05/11-06/15			DSN1378	12	1.6
760 i	Petrol	400	N74 B60 A		09/09-12/15			DSN1476	12	1.6
X1 (E84) (09-15)										
20 i	Petrol	135	N20 B20 A		09/11-06/15	- SS		DSN1375	12	1.3
20 xi	Petrol	135	N20 B20 A		09/11-06/15	- SS		DSN1375	12	1.3
25 xi	Petrol	160	N52 B30 A		03/10-08/11			DSN1375	12	1.3
28 xi 2.0	Petrol	180	N20 B20 A		03/11-06/15	- SS		DSN1375	12	1.3
28 xi 3.0	Petrol	190	N52 B30 A		09/09-08/11			DSN1375	12	1.3
X3 (E83) (04-11)										
2.5 si	Petrol	160	N52 B25 A; N52 B25 AF; N52 B25 BF		08/06-08/08			DSN1375	12	1.3

									
BMW continued									
X3 (E83) (04-11) continued									
2.5 sxi	Petrol	155	N52 B25 A; N52 B25 AF; N52 B25 BF		08/06-08/08		DSN1375	12	1.3
3.0 si	Petrol	200	N52 B30 A;N52 B30 BF		08/06-08/08		DSN1375	12	1.3
25 xi	Petrol	160	N52 B25 A; N52 B25 AF; N52 B25 BF		09/08-08/10		DSN1375	12	1.3
30 xi	Petrol	200	N52 B30 A;N52 B30 BF		09/08-08/10		DSN1375	12	1.3
X3 (F25) (10-17)									
20 i 1.6	Petrol	125	N20 B16 A		04/14-08/17	- SS	DSN1375	12	1.3
20 i 2.0	Petrol	135	N20 B20 A		04/14-08/17	- SS	DSN1375	12	1.3
20 xi	Petrol	135	N20 B20 A		10/11-08/17	- SS	DSN1375	12	1.3
28 xi 2.0	Petrol	180	N20 B20 A		04/12-08/17	- SS	DSN1375	12	1.3
28 xi 3.0	Petrol	190	N52 B30 A; N52 B30 AF; N52 B30 BF		01/11-10/12		DSN1375	12	1.3
35 xi	Petrol	225	N55 B30 A		09/10-08/17		DSN1376	12	1.6
X4 (F26) (14-18)									
35 xi	Petrol	225	N55 B30 A		04/14-03/18		DSN1376	12	1.6
M 40 i	Petrol	265	N55 B30 A		12/15-03/18		DSN1376	12	1.6
X5 (E70) (07-13)									
3.0 si	Petrol	200	N52 B30 A; N52 B30 AF; N52 B30 BF		10/06-09/08		DSN1375	12	1.3
30 xi	Petrol	200	N52 B30 A		10/08-03/10		DSN1375	12	1.3
35 xi	Petrol	225/235	N55 B30 A		04/10-07/13		DSN1375	12	1.3
50 xi	Petrol	300	N63 B44 A		04/10-07/13		DSN1377	12	1.6
M 4.4	Petrol	408	S63 B44 A		07/09-07/13		DSN1377	12	1.6
X5 (F15) (12-18)									
35 xi	Petrol	225/240	N55 B30 A		12/13-07/18		DSN1376	12	1.6
50 xi	Petrol	330	N63 B44 B		08/13-07/18		DSN1378	12	1.6
M 4.4	Petrol	423	S63 B44 B		12/14-07/18		DSN1378	12	1.6
X6 (E71, E72) (08-14)									
35 xi	Petrol	225/235/ 240	N54 B30 A;N55 B30 A		06/07-07/14		DSN1375	12	1.3
50 xi	Petrol	300/330	N63 B44 A		10/07-07/14		DSN1377	12	1.6
M 4.4	Petrol	408	S63 B44 A		07/09-07/14		DSN1377	12	1.6
X6 (F16) (14-19)									
35 xi	Petrol	225/240	N55 B30 A		08/14-07/19		DSN1376	12	1.6
50 xi	Petrol	330	N63 B44 B		08/14-07/19		DSN1378	12	1.6
M 4.4	Petrol	423	S63 B44 B		12/14-07/19		DSN1378	12	1.6
Z4 (E85, E86) (03-09)									
2.5 i	Petrol	130	N52 B25 A		09/05-02/09		DSN1375	12	1.3
2.5 si	Petrol	160	N52 B25 A		01/06-08/08		DSN1375	12	1.3
3.0 si	Petrol	195	N52 B30 A;N52 B30 BF		01/06-08/08		DSN1375	12	1.3
Z4 (E89) (09-16)									
18 i	Petrol	115	N20 B20 A		04/13-08/16	- SS	DSN1375	12	1.3
20 i	Petrol	120/135	N20 B20 A		09/11-08/16	- SS	DSN1375	12	1.3
23 i	Petrol	150	N52 B25 A;N52 B25 BF		03/09-08/11		DSN1375	12	1.3
28 i	Petrol	180	N20 B20 A		09/11-08/16	- SS	DSN1375	12	1.3
30 i	Petrol	190	N52 B30 A;N52 B30 B; N52 B30 BF		02/09-08/11		DSN1375	12	1.3
35 i	Petrol	225	N54 B30 A		02/09-08/16		DSN1375	12	1.3
35 is	Petrol	250	N54 B30 A		03/10-08/16		DSN1375	12	1.3
CHEVROLET									
AVEO / KALOS (T200) (03-08)									
1.4	Petrol	61/69	L14(85CUL4); LX5(85CUL4)		05/03-05/08		DSN3009	12	1.1
1.4 16V	Petrol	69	L14(85CUL4)		05/03-05/08		DSN3009	12	1.1
1.5	Petrol	63	LV8(91CUL4)		10/04-05/08		DSN3009	12	1.1
AVEO / KALOS (T250, T255) (05-)									
1.2	Petrol	62	LMU	MTM	01/08-		DSN3009	12	1.1
1.2 LPG	Petrol/ Liquified Petroleum Gas (LPG)	62	LMU	MTM	04/08-12/11		DSN3009	12	1.1



kW



CHEVROLET continued										
AVEO / KALOS (T250, T255) (05-) continued										
1.4	Petrol	61/69	L14(85CUL4);L95; LX5(85CUL4)		03/05-		DSN3009	12	1.1	
1.4 16V	Petrol	69	L14(85CUL4)		06/06-05/08		DSN3009	12	1.1	
1.5	Petrol	62	F15S3;LX6		05/05-		DSN3009	12	1.1	
CRUZE (09-)										
1.6	Petrol	80	LXT		05/09-		DSN3009	12	1.1	
LACETTI (03-)										
1.4 16V	Petrol	70	L14(85CUL4)		03/05-03/13		DSN3009	12	1.1	
1.6	Petrol	80	L44(96CUL4);LXT		03/05-		DSN3009	12	1.1	
1.8	Petrol	90	LDA		08/05-12/11		DSN3009	12	1.1	
LANOS (05-18)										
1.5	Petrol	64	LX6		11/05-12/18		DSN3009	12	1.1	
1.6 16V	Petrol	78	L44(96CUL4)		11/05-12/10		DSN3009	12	1.1	
NUBIRA (05-11)										
1.4	Petrol	69	L14(85CUL4)		01/05-12/08		DSN3009	12	1.1	
1.6	Petrol	80	L44(96CUL4);LXT		03/05-12/11		DSN3009	12	1.1	
1.6 LPG	Petrol/ Liquified Petroleum Gas (LPG)	80	L44(96CUL4);LXT		03/05-12/10		DSN3009	12	1.1	
1.8	Petrol	90	LDA		08/05-12/11		DSN3009	12	1.1	
OPTRA (03-08)										
1.6	Petrol	78/80	L44(96CUL4);LXT		08/03-12/08		DSN3009	12	1.1	
REZZO (05-)										
1.6	Petrol	77/79	L44(96CUL4)		03/05-		DSN3009	12	1.1	
CITROËN										
BERLINGO (MF) (96-11)										
1.9 D	Diesel	51	WJY (DW8B); WJZ (DW8)	5MTM	07/98-10/05		DSN3004	12	1.4	
1.9 D 4WD	Diesel	51	WJY (DW8B); WJZ (DW8)	5MTM	07/98-10/05		DSN3004	12	1.4	
1.9 D 70	Diesel	51	WJY (DW8B); WJZ (DW8)	5MTM	04/99-12/11		DSN3004	12	1.4	
1.9 D 70 4WD	Diesel	51	WJY (DW8B); WJZ (DW8)	5MTM	07/98-03/06		DSN3004	12	1.4	
2.0 HDi 90	Diesel	66	RHY (DW10TD)		12/99-12/11		DSN3004	12	1.4	
2.0 HDi 90 4x4	Diesel	66	RHY (DW10TD)		11/00-10/05		DSN3004	12	1.4	
C1 II (14-)										
1.2 VTI 82	Petrol	60	HMT (EB2D); HMZ (EB2); HMZ (EB2F)		04/14-	- SS	DSN1368	12	1	
C3 II (09-)										
1.0 VTI 68	Petrol	50	ZMZ (EB0)	MTM	08/12-		DSN1368	12	1	
1.2 VTI 82	Petrol	60	HMZ (EB2); HMZ (EB2F)	MTM	06/12-09/16	- SS	DSN1368	12	1	
C3 III (16-)										
1.2 PureTech 82	Petrol	60	HMR (EB2FA)		05/18-		DSN1368	12	1	
1.2 VTI 68	Petrol	50	HMM (EB2FAD); HMP (EB2FB)		07/16-		DSN1368	12	1	
1.2 VTI 82	Petrol	60	HMZ (EB2F)		07/16-	- SS	DSN1368	12	1	
C4 (Grand) Picasso I (06-13)										
1.8 BiFuel	Flexfuel	92	6FY (EW7A)		01/09-10/12	- SS	DSN3004	12	1.4	
1.8 i 16V	Petrol	92	6FY (EW7A)		10/06-12/11	- SS	DSN3004	12	1.4	
2.0 i 16V	Petrol	103	RFJ (EW10A)		10/06-08/13	- SS	DSN3004	12	1.4	
C4 Cactus (14-)										
1.2 VTI / PureTech 75	Petrol	55	HMU (EB2D); HMU (EB2FD)	MTM	09/14-		DSN1368	12	1	
1.2 VTI 82	Petrol	60	HMZ (EB2F)	MTM	09/14-	- SS	DSN1368	12	1	
C4 Coupe (04-11)										
2.0 16V	Petrol	100/130	RFK (EW10J4S); RFN (EW10J4)		11/04-12/10	- SS	DSN3004	12	1.4	
2.0 VTR	Petrol	103	RFJ (EW10A)		10/06-12/07	- SS	DSN3004	12	1.4	
C4 I (LC, LR) (04-11)										
2.0 16V	Petrol	100/103/ 105	RFJ (EW10A); RFN (EW10J4)		11/04-07/11	- SS	DSN3004	12	1.4	
C5 I (01-04)										
1.8 16V	Petrol	85	6FZ (EW7J4)		03/01-08/04	- SS	DSN3004	12	1.4	
2.0 16V	Petrol	100	RFN (EW10J4)		03/01-08/04	- SS	DSN3004	12	1.4	
2.0 16V HPI	Petrol	103	RLZ (EW10D)		03/01-08/04	- SS	DSN3004	12	1.4	
C5 II (04-)										
1.8	Petrol	85	6FZ (EW7J4)		09/04-08/05	- SS	DSN3004	12	1.4	

									
CITROËN continued									
C5 II (04-) continued									
1.8 16V	Petrol	85/92	6FY (EW7A); 6FZ (EW7J4)		09/04-	- SS	DSN3004	12	1.4
2.0	Petrol	103	RFJ (EW10A)		11/04-01/08	- SS	DSN3004	12	1.4
2.0 16V	Petrol	103	RFJ (EW10A)		09/04-	- SS	DSN3004	12	1.4
C5 III (08-)									
1.8 16V	Petrol	92	6FY (EW7A)		02/08-	- SS	DSN3004	12	1.4
2.0 16V	Petrol	103	RFJ (EW10A)		02/08-		DSN3004	12	1.4
2.0 16V BioFlex	Flexfuel	103	RFJ (EW10A)		02/08-		DSN3004	12	1.4
2.7 HDi 204	Diesel	150	DT17TED4		02/08-		DSN942	12	2.2
3.0 HDi 240	Diesel	177	DT20C		04/09-10/14		DSN942	12	2.2
C6 (05-14)									
2.7 HDi 204	Diesel	150	DT17TED4		09/05-12/11		DSN942	12	2.2
3.0 HDi 240	Diesel	177	DT20C		04/09-12/12		DSN942	12	2.2
C8 (02-)									
2.0	Petrol	100	RFN (EW10J4)		07/02-	- SS	DSN3004	12	1.4
2.0 16V	Petrol	103	RFJ (EW10A)		09/05-	- SS	DSN3004	12	1.4
2.2	Petrol	116	3FZ (EW12J4)		07/02-	- SS	DSN3004	12	1.4
C15 (84-05)									
1.8 D	Diesel	44	161A (XUD7)		07/86-12/00		DSN3004	12	1.4
C-ELYSEE (12-)									
1.2 VTi 72	Petrol	53	HMY (EB2M)	MTM	11/12-	- SS	DSN1368	12	1
1.2 VTi 82	Petrol	60	HMZ (EB2); HMZ (EB2F)	MTM	12/14-	- SS	DSN1368	12	1
DS3 (09-15)									
1.2 VTi 82	Petrol	60	HMZ (EB2); HMZ (EB2F)	MTM	01/13-07/15	- SS	DSN1368	12	1
EVASION (94-02)									
2.0 16V	Petrol	100	RFN (EW10J4)		05/00-07/02	- SS	DSN3004	12	1.4
JUMPER (02-)									
2.8 HDi 128	Diesel	94	8140.43S		04/02-		DSN3014	12	2.5
2.8 HDi 128 4x4	Diesel	94	8140.43S;F28TDCR		02/02-		DSN3014	12	2.5
2.8 HDi 146	Diesel	107	8140.43N		05/04-		DSN3014	12	2.5
JUMPER (06-)									
2.2 HDi 100	Diesel	74	4HV (P22DTE)		04/06-		DSN3012	12	2
2.2 HDi 110	Diesel	81	4HG (P22DTE)		07/11-		DSN3012	12	2
2.2 HDi 120	Diesel	88	4HU (P22DTE)		04/06-		DSN3012	12	2
2.2 HDi 130	Diesel	96	4HH (P22DTE)		07/11-	- SS	DSN3012	12	2
2.2 HDi 150	Diesel	110	4HJ (P22DTE)		07/11-	- SS	DSN3012	12	2
3.0 HDi 145	Diesel	107	F30DTE (F1CE3481N)		07/10-		DSN3013	12	2.5
3.0 HDi 155	Diesel	115	F1CE0481D (F30DT)		07/10-		DSN3013	12	2.5
3.0 HDi 160	Diesel	116	F1CE0481D (F30DT)		09/06-		DSN3013	12	2.5
3.0 HDi 180	Diesel	130	F1CE3481E (F30DTE)		07/11-		DSN3013	12	2.5
JUMPY (95-06)									
1.9 D 70	Diesel	51	WJY (DW8B); WJZ (DW8)		04/98-11/03		DSN3004	12	1.4
1.9 D 70	Diesel	51	WJY (DW8B); WJZ (DW8)	5MTM	04/98-10/06		DSN3004	12	1.4
2.0	Petrol	100	RFN (EW10J4)		04/00-12/06	- SS	DSN3004	12	1.4
2.0 HDi 110	Diesel	80	RHW (DW10ATED4); RHZ (DW10ATED); RHZ (DW10BTED); RHZ (DW10BTED+); RHZ (DW10CTED); RHZ (DW10CTED+)		03/00-10/06		DSN3004	12	1.4
2.0 HDi 95	Diesel	69	RHX (DW10BTED)		10/99-10/06		DSN3004	12	1.4
2.0 i 16V	Petrol	102	RFN (EW10J4)		03/00-10/06	- SS	DSN3004	12	1.4
JUMPY (06-)									
2.0 HDi 120	Diesel	88	RHK (DW10UTED4)	MTM	01/07-03/16		DSN3004	12	1.4
2.0 i	Petrol	103	RFH (EW10A); RFJ (EW10A)		01/07-03/16	- SS	DSN3004	12	1.4
XSARA (97-05)									
1.9 D	Diesel	51	WJY (DW8B); WJZ (DW8)	5MTM	07/98-08/05		DSN3004	12	1.4
2.0 16V	Petrol	100	RFN (EW10J4)		09/00-08/05	- SS	DSN3004	12	1.4
2.0 HDi 110	Diesel	80	RHZ (DW10ATED)		05/01-08/05		DSN3004	12	1.4
2.0 HDi 90	Diesel	66	RHY (DW10TD)		02/99-08/05		DSN3004	12	1.4
XSARA Picasso (99-11)									
1.8 16V	Petrol	85	6FZ (EW7J4)		02/00-08/05	- SS	DSN3004	12	1.4
2.0 16V	Petrol	100	RFN (EW10J4)		01/03-06/12	- SS	DSN3004	12	1.4
2.0 HDi 90	Diesel	66	RHY (DW10TD)		12/99-12/11		DSN3004	12	1.4
DAEWOO									
KALOS (02-)									
1.4	Petrol	61/69	F14D3;F14S3		09/02-		DSN3009	12	1.1



kW

DAEWOO continued										
KALOS (02-) continued										
1.4 16V	Petrol	69	F14D3		04/03-		DSN3009	12	1.1	
1.5	Petrol	62	F15S		11/02-12/04		DSN3009	12	1.1	
KORANDO (99-)										
3.2 4x4	Petrol	156	M 104.995		01/99-12/14		DSN3011	12	2.2	
LACETTI (04-)										
1.4	Petrol	70	F14D3		06/02-12/14		DSN3009	12	1.1	
1.6	Petrol	80	F16D3		02/04-12/14		DSN3009	12	1.1	
1.8	Petrol	90	T18SED		02/04-12/14		DSN3009	12	1.1	
LANOS (97-)										
1.3	Petrol	55	L13(82CUL4)		05/97-12/14		DSN3009	12	1.1	
1.5	Petrol	63	LX6(91CUL4)	ATM	05/97-		DSN3009	12	1.1	
1.5	Petrol	63/73	L43(91CUL4); LX6(91CUL4)		05/97-12/14		DSN3009	12	1.1	
1.6 16V	Petrol	78	L44(98CUL4)		02/97-12/14		DSN3009	12	1.1	
MUSSO (99-)										
3.2 4x4	Petrol	162	M 104.992		01/99-12/14		DSN3011	12	2.2	
NEXIA (95-08)										
1.5	Petrol	59	G15MF		08/97-12/14		DSN3009	12	1.1	
1.6	Petrol	80	LXV		08/97-12/14		DSN3009	12	1.1	
NEXIA (08-)										
1.5	Petrol	59	Y15L		07/08-12/14		DSN3009	12	1.1	
1.6	Petrol	80	F16D3		07/08-12/14		DSN3009	12	1.1	
NUBIRA (97-)										
1.6 16V	Petrol	76/78	A16DMS		05/97-12/14		DSN3009	12	1.1	
NUBIRA (03-)										
1.6	Petrol	80	F16D3		07/03-12/14		DSN3009	12	1.1	
DS										
DS3 (15-19)										
1.2 VTI 82	Petrol	60	HMZ (EB2F)		07/15-07/19		DSN1368	12	1	
FERRARI										
599 GTB / GTO (06-)										
6.0 GTB	Petrol	450/456	F134FB61		06/06-		DSN1457	12	1.4	
6.0 GTO	Petrol	489/493	F134FB61;F140CE		04/10-		DSN1457	12	1.4	
599 SA (10-)										
6.0	Petrol	489	F134FB61		09/10-		DSN1457	12	1.4	
ENZO (02-03)										
6.0	Petrol	485	F 140 B49		10/02-12/03		DSN1457	12	1.4	
F430 (Spider) (05-09)										
4.3	Petrol	357/360/ 372/375	F 131 B43;F 131 B47; F 136 ED		03/05-12/09		DSN1457	12	1.4	
FIAT										
500 (C) (312) (07-)										
0.9	Petrol	48	312 A4.000		09/12-		DSN975	12	1.4	
0.9 TwinAir	Petrol	59/63/77	199 B6.000;312 A2.000; 312 A5.000		09/09-	BO	DSN975	12	1.4	
500L (12-)										
0.9 Natural Power	Petrol/ Compre ssed Natur al Gas(CNG)	59	312 A2.000		04/17-		DSN975	12	1.4	
0.9 Natural Power	Petrol/ Compre ssed Natur al Gas(CNG)	63	312 A2.000		03/13-	BO	DSN975	12	1.4	
0.9 TwinAir	Petrol	77	199 B6.000		09/12-	BO	DSN975	12	1.4	
ALBEA / SIENA (96-11)										
1.4	Petrol	51	178 B2.000	MTM	07/97-10/03	Ch No: >3038861	DSN577	12	1.0	
1.4	Petrol	57	178 F3.011;350 A1.000		01/07-12/09		DSN3018	12	2	
1.4 Cat	Petrol	51	178 B2.016	MTM	07/97-10/03		DSN577	12	1.0	
1.6	Petrol	76	182 B6.000	MTM	01/02-12/12		DSN577	12	1.0	
1.6 16V	Petrol	74	178 B3.000	MTM	09/98-12/01		DSN577	12	1.0	
BARCETTA (95-05)										
1.8 16V	Petrol	96	183 A1.000;188 A6.000	MTM	04/95-04/04		DSN579	12	1.4	
BRAVA (95-02)										
1.6 16V	Petrol	66/76	182 A4.000;182 A6.000	MTM	10/95-10/01		DSN577	12	1.0	
1.8 GT 16V	Petrol	83	182 A2.000	MTM	10/95-08/01		DSN577	12	1.0	

										
FIAT continued										
BRAVA (95-02) continued										
1.8 GT 16V	Petrol	83	182 A2.000	MTM	10/95-08/01			DSN579	12	1.4
1.9 JTD	Diesel	74	182 B9.000		09/00-12/14			DSN3018	12	2
1.9 JTD 105	Diesel	77	182 B4.000		12/98-12/14			DSN3018	12	2
1.9 TD 100 S	Diesel	74	182 A7.000		03/96-12/14			DSN3018	12	2
1.9 TD 75 S	Diesel	55	182 A8.000		03/96-12/14			DSN3018	12	2
BRAVO I (95-01)										
1.6 16V	Petrol	66	182 A6.000	MTM	10/95-10/01			DSN577	12	1.0
1.6 16V	Petrol	76	182 A4.000		03/96-10/01			DSN577	12	1.0
1.8 GT	Petrol	83	182 A2.000	MTM	11/96-10/01			DSN577	12	1.0
1.8 GT	Petrol	83	182 A2.000	MTM	11/96-10/01			DSN579	12	1.4
1.9 JTD	Diesel	74	182 B9.000		09/00-12/14			DSN3018	12	2
1.9 JTD 105	Diesel	77	182 B4.000		12/98-12/14			DSN3018	12	2
1.9 TD 100 S	Diesel	74	182 A7.000		03/96-12/14			DSN3018	12	2
1.9 TD 75 S	Diesel	55	182 A8.000		03/96-12/14			DSN3018	12	2
2.0 HGT 20V	Petrol	108	182 A1.000	MTM	11/96-07/98			DSN579	12	1.4
2.0 HGT 20V	Petrol	113	182 B7.000	MTM	07/98-08/00	Ch No: >5053877		DSN579	12	1.4
BRAVO II (06-14)										
1.6 D Multijet	Diesel	66/77/88	198 A2.000;198 A3.000; 198 A6.000		09/07-12/14	- SS		DSN3018	12	2
1.9 D Multijet	Diesel	66/85/ 88/110	192 A1.000;192 A8.000; 192 B4.000;192 B5.000; 937 A5.000		11/06-12/14			DSN3018	12	2
COUPE (93-00)										
1.8 16V	Petrol	96	183 A1.000	MTM	03/96-08/00			DSN579	12	1.4
2.0 20V	Petrol	108	182 A1.000	MTM	08/96-09/98			DSN579	12	1.4
2.0 20V	Petrol	113	182 B3.000		10/98-08/00			DSN579	12	1.4
2.0 20V Turbo	Petrol	162	175 A3.000	MTM	08/96-08/00			DSN579	12	1.4
CROMA (05-)										
1.9 D Multijet	Diesel	85/88/ 100/110	939 A1.000;939 A2.000; 939 A7.000;939 A8.000		06/05-			DSN3018	12	2
1.9 MJTD	Diesel	88	939 A1.000		04/06-12/11			DSN3018	12	2
2.4 D Multijet	Diesel	147	939 A3.000		06/05-			DSN3018	12	2
DOBLO (01-)										
1.3 D Multijet	Diesel	55/62	199 A2.000;223 A9.000		10/05-			DSN3018	12	2
1.3 JTD	Diesel	55	199 A2.000		05/05-			DSN3018	12	2
1.4	Petrol	57	350 A1.000		10/05-			DSN3018	12	2
1.9 D Multijet	Diesel	88	186 A9.000		10/05-			DSN3018	12	2
1.9 JTD	Diesel	74/77	182 B9.000;223 A7.000; 223 B1.000;223 B2.000		10/01-			DSN3018	12	2
DOBLO (10-)										
1.6 D Multijet	Diesel	66/74/77	198 A3.000;263 A3.000; 263 A4.000;263 A5.000; 263 A8.000;263 A9.000		01/10-	- SS		DSN3018	12	2
DUCATO (230) (94-02)										
2.8 TDI	Diesel	90	8140.43	MTM	12/98-04/02			DSN3013	12	2.5
DUCATO (244) (02-)										
2.0 JTD	Diesel	62	RHV		04/02-	Ch No: 7557255>7600144		DSN3013	12	2.5
2.3 JTD	Diesel	81	F1AE0481C		01/05-03/05	Ch No: 7557256>7600144		DSN3013	12	2.5
2.8 JTD	Diesel	90	8140.43		11/03-07/06			DSN3014	12	2.5
2.8 JTD	Diesel	94/107	8140.43N;8140.43S		01/05-03/05	Ch No: 7557256>7600144		DSN3013	12	2.5
2.8 JTD 4x4	Diesel	94	8140.43S		01/05-03/05	Ch No: 7557256>7600144		DSN3013	12	2.5
2.8 JTD Power	Diesel	107	8140.43N		01/05-03/05	Ch No: 7557256>7600144		DSN3013	12	2.5
2.8 TD	Diesel	90	8140.43	MTM	04/02-07/06			DSN3013	12	2.5
DUCATO (250, 290) (06-)										
2.2 D Multijet 100	Diesel	74	4HV		07/06-12/14			DSN3012	12	2
2.3 D Multijet 110	Diesel	83	F1AE3481G	MTM; SMT	08/06-			DSN3013	12	2.5
2.3 D Multijet 110	Diesel	83	F1AE3481G	MTM	10/11-	- SS		DSN3013	12	2.5
2.3 D Multijet 110	Diesel	83	F1AE3481G	MTM; SMT	10/11-	- SS		DSN3013	12	2.5
2.3 D Multijet 110	Diesel	83	F1AE3481G	MTM	10/11-	+ SS		DSN1301	12	2
2.3 D Multijet 110	Diesel	83	F1AE3481G		05/14-12/14			DSN3013	12	2.5
2.3 D Multijet 120	Diesel	88	F1AE0481D;F1AGL4114	MTM; SMT	07/06-12/14			DSN3013	12	2.5
2.3 D Multijet 120	Diesel	88	F1AE0481D;F1AGL4114	MTM; SMT	07/06-12/14	Eng No: F1AE3481D>		DSN1301	12	2



kW













kW

FIAT continued									
DUCATO (250, 290) (06-) continued									
2.3 D Multijet 120	Diesel	88	F1AE0481D;F1AGL4114		07/06-		DSN3013	12	2.5
2.3 D Multijet 120 4x4	Diesel	88	F1AE0481D		03/10-12/14		DSN3013	12	2.5
2.3 D Multijet 120 4x4	Diesel	88	F1AE0481D	MTM; SMT	03/10-12/14		DSN3013	12	2.5
2.3 D Multijet 130	Diesel	96	F1AE0481N;F1AE3481D; F1AGL411D		06/11-		DSN3013	12	2.5
2.3 D Multijet 130	Diesel	96	F1AE0481N;F1AE3481D; F1AGL411D	MTM	06/11-	Eng No: F1AE3481D>	DSN1301	12	2
2.3 D Multijet 130	Diesel	96	F1AE0481N;F1AE3481D; F1AGL411D	MTM; SMT	07/06-	- SS	DSN3013	12	2.5
2.3 D Multijet 130 4x4	Diesel	96	F1AE0481N;F1AE3481D; F1AGL411D		06/11-12/14		DSN3013	12	2.5
2.3 D Multijet 130 4x4	Diesel	96	F1AE0481N;F1AE3481D; F1AGL411D	MTM; SMT	06/11-	- SS	DSN3013	12	2.5
2.3 D Multijet 150	Diesel	109	F1AE3481E	MTM	06/11-		DSN3013	12	2.5
2.3 D Multijet 150	Diesel	109	F1AE3481E	MTM; SMT	06/11-	- SS	DSN3013	12	2.5
2.3 D Multijet 150	Diesel	109	F1AE3481E	MTM	06/11-	+ SS	DSN1301	12	2
2.3 D Multijet 150	Diesel	109	F1AGL411A;F1AGL411C		04/15-		DSN3013	12	2.5
2.3 D Multijet 150 4x4	Diesel	110	F1AGL411A;F1AGL411C		04/15-		DSN3013	12	2.5
2.3 D Multijet 180	Diesel	130	F1AGL4111;F1AGL411B		12/15-		DSN3013	12	2.5
3.0 D Multijet 140	Diesel	103	F1CE3481N		07/06-12/14		DSN3013	12	2.5
3.0 D Multijet 150	Diesel	107	F1CE3481N		04/10-12/14		DSN3013	12	2.5
3.0 D Multijet 160	Diesel	116	F1CE0481D;F1CE3481M		07/06-12/14		DSN3013	12	2.5
3.0 D Multijet 160 4x4	Diesel	116	F1CE0481D;F1CE3481M		07/06-12/14		DSN3013	12	2.5
3.0 D Multijet 180	Diesel	130	F1CE3481E		05/14-11/16		DSN3013	12	2.5
3.0 Natural Power 140	CNG	100	F1CE0441A;F1CFA401A; F1CFA401C		07/16-		DSN3013	12	2.5
FIORINO (07-)									
1.4	Petrol	57	350 A1.000		10/09-		DSN3018	12	2
1.4 Natural Power	Petrol/ Compressed Natural Gas (CNG)	51/57	350 A1.000		06/08-		DSN3018	12	2
Grande PUNTO (05-)									
0.9 TwinAir	Petrol	63	312 A2.000		03/12-		DSN975	12	1.4
1.3 D Multijet	Diesel	55	199 A2.000;199 A9.000		10/05-		DSN3018	12	2
1.4	Petrol	57	350 A1.000		06/05-		DSN3018	12	2
1.4 LPG	Petrol/ Liquified Petroleum Gas (LPG)	57	350 A1.000		12/08-		DSN3018	12	2
1.4 Natural Power	Petrol/ Compressed Natural Gas (CNG)	57	350 A1.000		07/08-		DSN3018	12	2
1.6 D Multijet	Diesel	88	955 A3.000		07/08-	- SS	DSN3018	12	2
1.9 D Multijet	Diesel	85/88/96	199 A5.000;939 A1.000; 939 A7.000		10/05-		DSN3018	12	2
IDEA (03-)									
1.4	Petrol	57	350 A1.000		10/05-		DSN3018	12	2
1.4 LPG	Petrol/ Liquified Petroleum Gas (LPG)	57	350 A1.000		03/09-		DSN3018	12	2
1.6 D Multijet	Diesel	88	350 A2.000		05/08-	- SS	DSN3018	12	2
1.9 JTD	Diesel	74	188 B2.000		01/04-		DSN3018	12	2
LINEA (07-)									
1.4	Petrol	57	350 A1.000		06/07-		DSN3018	12	2
1.6 D Multijet	Diesel	77	198 A3.000		06/09-	- SS	DSN3018	12	2
MAREA (96-07)									
1.6 100 16V	Petrol	76	182 A4.000	MTM	09/96-08/00		DSN577	12	1.0
1.8 115 16V	Petrol	83	182 A2.000		09/96-08/00		DSN577	12	1.0
1.8 115 16V	Petrol	83	182 A2.000		09/96-08/00		DSN579	12	1.4
1.9 JTD	Diesel	79	182 B4.000;182 B9.000		01/01-12/07		DSN3018	12	2
1.9 JTD 105	Diesel	77	182 B4.000		12/98-12/02		DSN3018	12	2

Starters & Alternators

Application Tables - Starters

											
FIAT continued											
MAREA (96-07) continued											
1.9 JTD 110	Diesel	81	186 A6.000			09/00-08/02			DSN3018	12	2
1.9 TD 100	Diesel	74	182 A7.000;182 B9.000			05/96-06/03			DSN3018	12	2
1.9 TD 75	Diesel	55	182 A8.000			09/96-05/02			DSN3018	12	2
2.0 150 20V	Petrol	110	182 A1.000			09/96-04/99			DSN579	12	1.4
2.0 150 20V	Petrol	110	185 A8.000	MTM		01/01-05/02			DSN579	12	1.4
2.0 155 20V	Petrol	113	182 B7.000			04/99-08/00			DSN579	12	1.4
2.4 JTD 130	Diesel	96	185 A6.000			04/99-08/00			DSN579	12	1.4
2.4 JTD 130	Diesel	96	185 A6.000;839 A5.000			04/99-05/02			DSN3018	12	2
MULTIPLA (99-10)											
1.9 JTD	Diesel	88	186 A9.000			04/02-06/10			DSN3018	12	2
1.9 JTD 105	Diesel	77	182 B4.000			04/99-06/10			DSN3018	12	2
1.9 JTD 110	Diesel	81	186 A6.000			03/01-07/02			DSN3018	12	2
1.9 JTD 115	Diesel	85	186 A8.000			07/02-06/10			DSN3018	12	2
PALIO (96-)											
1.2	Petrol	44	178 C4.066;188 A4.000	MTM		07/97-10/04			DSN577	12	1.0
1.4	Petrol	57/63	178 F3.011;350 A1.000			10/02-			DSN3018	12	2
1.6 16V	Petrol	74	178 B3.000	MTM		04/96-10/02			DSN577	12	1.0
1.9 JTD	Diesel	59	188 A2.000			09/01-			DSN3018	12	2
PANDA (03-)											
1.4 Natural Power	Petrol/ Compressed Natural Gas (CNG)	57	350 A1.000			10/09-			DSN3018	12	2
PANDA (12-)											
0.9	Petrol	44/48	312 A4.000;312 A6.000			02/12-			DSN975	12	1.4
0.9 Natural Power	Petrol/ Compressed Natural Gas (CNG)	59/63	312 A2.000			07/12-			DSN975	12	1.4
0.9 Natural Power	Petrol/ Compressed Natural Gas (CNG)	63	312 A2.000;463 37 566			07/12-	BO		DSN975	12	1.4
0.9 TwinAir	Petrol	57/63	312 A2.000;312 A7.000			02/12-	BO		DSN975	12	1.4
0.9 TwinAir	Petrol	59/63/66	312 A2.000;312 A5.000; 312 A7.000			02/12-			DSN975	12	1.4
0.9 TwinAir 4x4	Petrol	63	312 A2.000			09/12-			DSN975	12	1.4
PUNTO (99-12)											
1.8 130 HGT	Petrol	96	188 A6.000			09/99-06/03			DSN579	12	1.4
1.9 JTD	Diesel	63/74	188 A7.000;188 B2.000			02/00-03/12			DSN3018	12	2
1.9 JTD 80	Diesel	59	188 A2.000			09/99-03/12			DSN3018	12	2
PUNTO (12-)											
0.9 BiFuel	Petrol/ Liquefied Petroleum Gas (LPG)	63	312 A2.000			03/12-	BO		DSN975	12	1.4
0.9 Twinair	Petrol	63/74/77	199 B6.000;199 B7.000; 312 A2.000			03/12-	BO		DSN975	12	1.4
1.3 D Multijet	Diesel	55	199 A2.000;199 A9.000			03/12-			DSN3018	12	2
1.4	Petrol	57	350 A1.000			03/12-			DSN3018	12	2
1.4 BiFuel	Petrol/ Liquefied Petroleum Gas (LPG)	57	350 A1.000			03/12-			DSN3018	12	2
1.4 Natural Power	Petrol/ Compressed Natural Gas (CNG)	57	350 A1.000			03/12-			DSN3018	12	2























kW











FIAT <i>continued</i>									
PUNTO Evo (08-12)									
1.3 D Multijet	Diesel	55	199 A2.000;199 A9.000		10/09-02/12		DSN3018	12	2
1.4	Petrol	57	350 A1.000		03/09-02/12		DSN3018	12	2
1.4 LPG	Petrol/ Liquified Petrol Gas (LPG)	57	350 A1.000		06/09-02/12		DSN3018	12	2
1.4 Natural Power	Petrol/ Compressed Natural Gas (CNG)	57	350 A1.000		10/09-02/12		DSN3018	12	2
1.6 D Multijet	Diesel	88	955 A3.000		10/09-02/12	- SS	DSN3018	12	2
QUBO (08-)									
1.4	Petrol	57	350 A1.000		10/09-		DSN3018	12	2
1.4 Natural Power	Petrol/ Compressed Natural Gas (CNG)	57	350 A1.000		10/09-		DSN3018	12	2
SCUDO (220) (96-06)									
1.9 D	Diesel	51	WJY (DW8B); WJZ (DW8)	5MTM	04/98-12/06		DSN3004	12	1.4
SEDICI (06-14)									
1.9 D Multijet	Diesel	88	D19AA		06/06-10/11		DSN3018	12	2
1.9 D Multijet 4x4	Diesel	88	D19AA		06/06-10/11		DSN3018	12	2
STILO (01-08)									
1.4 16V	Petrol	66	192 B2.000	MTM	03/05-08/08		DSN579	12	1.4
1.8 16V	Petrol	98	192 A4.000	MTM	10/01-08/08		DSN579	12	1.4
1.9 D	Diesel	66	192 B5.000		09/04-08/08		DSN3018	12	2
1.9 D Multijet	Diesel	74/88/ 110	192 A8.000;192 A9.000; 937 A5.000		09/05-08/08		DSN3018	12	2
1.9 JTD	Diesel	59/66/ 85/93/ 100/103	192 A1.000;192 A3.000; 192 A5.000;192 B1.000; 192 B5.000;937 A4.000; 937 A7.000		10/01-08/08		DSN3018	12	2
2.4 20V	Petrol	125	192 A2.000	MTM	10/01-04/07		DSN579	12	1.4
STRADA (99-)									
1.9 JTD	Diesel	59	188 A2.000		04/03-		DSN3018	12	2
TEMPRA (90-96)									
1.4 i.e.	Petrol	51	159 A2.000;160 A1.046; 836 A4.000	MTM	04/90-08/96		DSN577	12	1.0
1.8 i.e.	Petrol	66/74/ 77/81	159 A4.000;159 A4.046; 835 C2.000;835 C4.000; 836 A5.000	MTM	03/90-08/96		DSN577	12	1.0
1.8 i.e.	Petrol	77/81	159 A4.000;159 A4.046; 835 C2.000	MTM	03/90-08/96	Ch No: >7234930	DSN579	12	1.4
2.0 i.e.	Petrol	83	159 A6.046	MTM	10/90-06/93		DSN577	12	1.0
2.0 i.e.	Petrol	83	159 A6.046	MTM	10/90-06/93	Ch No: >7234930	DSN579	12	1.4
2.0 i.e.	Petrol	83	159 A6.046	MTM	01/91-06/93	Ch No: 7234931>	DSN577	12	1.0
2.0 i.e. 4x4	Petrol	83	159 A6.046	MTM	07/92-03/95		DSN577	12	1.0
2.0 i.e. 4x4	Petrol	83	159 A6.046	MTM	07/92-03/95	Ch No: >7234930	DSN579	12	1.4
FORD									
B-MAX (12-)									
1.4	Petrol	66	SPJD;SPJE		10/12-		DSN3001	12	1.1
1.4 LPG	Petrol/ Liquified Petrol Gas (LPG)	64/66	RTJC		08/13-		DSN3001	12	1.1
1.6 Ti	Petrol	77	IQJA;IQJC		10/12-		DSN3001	12	1.1
C-MAX I (07-10)									
1.6	Petrol	74	HWDA;HWDB;SHDA; SHDB;SHDC		02/07-09/10		DSN3001	12	1.1
C-MAX II (10-)									
1.6 CNG	Petrol/ Compressed Natural Gas (CNG)	86	MUDA		01/13-12/14		DSN3001	12	1.1











Starters & Alternators











Application Tables - Starters









									
FORD continued									
C-MAX II (10-) continued									
1.6 FlexFuel	Flexfuel	88	MUDA;MUDD		02/11-		DSN3001	12	1.1
1.6 LPG	Petrol/ Liquified Petroleum Gas (LPG)	86/88	MUDA;MUDD		02/12-		DSN3001	12	1.1
1.6 Ti	Petrol	63/77/ 88/92	IQDA;IQDB;MUDA; MUDD;PNDA;PNDD; XTDA;XTDB		12/10-		DSN3001	12	1.1
ECOSPORT (12-)									
1.5 Ti	Petrol	82	UEJB;UEJE		10/13-		DSN3001	12	1.1
ESCORT VI (95-01)									
1.3	Petrol	44	J4B;J6A		01/95-02/99	- SS	DSN3003	12	1.1
FIESTA IV (95-03)									
1.25 i 16V	Petrol	55	DHA;DHB;DHC;DHD; DHE;DHF;DHG		08/95-01/02		DSN3001	12	1.1
1.3 i	Petrol	37/44	J4C;J4J;J4L;J4Q;J4R; J4T;JBC;JJA;JJC; JJE;JJJ;JJK;JJM		08/95-01/02	- SS	DSN3003	12	1.1
FIESTA V (01-08)									
1.25 16V	Petrol	51/55	FUJA;FUJB;M7JA;M7JB		05/02-06/08	- SS	DSN3001	12	1.1
1.3	Petrol	44/51	A9JA;A9JB;BAJA		11/01-08/08	- SS	DSN3002	12	1.1
1.4	Petrol	59	FXJA		05/02-09/05		DSN3001	12	1.1
1.4 16V	Petrol	59	FXJA;FXJB		11/01-06/08		DSN3001	12	1.1
1.6 16V	Petrol	74	FYJA;FYJB		11/01-06/08		DSN3001	12	1.1
FIESTA VI (08-)									
1.25	Petrol	44/60	SNJA;SNJB;SNJC; SNJD;STJA;STJB; STJC;STJD		06/08-	- SS	DSN3001	12	1.1
1.4	Petrol	71	RTJA;RTJB;SPJA; SPJC;SPJE		10/08-		DSN3001	12	1.1
1.4 LPG	Petrol/ Liquified Petroleum Gas (LPG)	68/71	RTJA;RTJB;RTJD; SPJA;SPJC;SPJE		01/09-		DSN3001	12	1.1
1.6	Petrol	89	HXJA		10/10-		DSN3001	12	1.1
1.6 Ti	Petrol	77/88/99	HXJA;HXJB;HXJE; IQJA;IQJC;IQJE;U5JA		06/08-		DSN3001	12	1.1
1.6 Ti-VCT	Petrol	88	HXJA;HXJB		10/08-12/12		DSN3001	12	1.1
FOCUS C-MAX (03-07)									
1.6	Petrol	74	HWDA;HWDB;SHDA; SHDB;SHDC		10/03-03/07		DSN3001	12	1.1
1.6 Ti	Petrol	85	HXDA;SIDA		08/04-03/07		DSN3001	12	1.1
FOCUS I (98-05)									
1.4	Petrol	55	FXDA;FXDB;FXDC; FXDD		04/99-03/05		DSN3001	12	1.1
1.4 16V	Petrol	55	FXDA;FXDB;FXDC; FXDD		10/98-11/04		DSN3001	12	1.1
1.6	Petrol	74	FYDA;FYDB;FYDC; FYDD		04/99-03/05		DSN3001	12	1.1
1.6 16V	Petrol	74	FYDA;FYDB;FYDC; FYDD;FYDH		10/98-11/04		DSN3001	12	1.1
1.6 16V FlexFuel	Flexfuel	75	FYDH		01/02-11/04		DSN3001	12	1.1
FOCUS II (04-12)									
1.4	Petrol	59	ASDA;ASDB		07/04-09/12		DSN3001	12	1.1
1.6	Petrol	74	HWDA;HWDB;SHDA; SHDB;SHDC		07/04-09/12		DSN3001	12	1.1
1.6 LPG	Petrol/ Liquified Petroleum Gas (LPG)	85	SIDA		10/09-09/12		DSN3001	12	1.1
1.6 Ti	Petrol	85	HXDA;HXDB;SIDA		07/04-09/12		DSN3001	12	1.1
FOCUS III (10-)									
1.6 FlexFuel	Flexfuel	88	MUDA;MUDD		07/10-		DSN3001	12	1.1
1.6 LPG	Petrol/ Liquified Petroleum Gas (LPG)	86/88	MUDA;MUDD		02/12-		DSN3001	12	1.1











									
FORD continued									
FOCUS III (10-) continued									
1.6 Ti	Petrol	63/77/88/92	IQDA;IQDB;IQDC; MUDDA;MUDD;PNDA; PNDD;XTDA;XTDB		07/10-		DSN3001	12	1.1
FUSION (02-12)									
1.25	Petrol	55	FUJA;FUJB		08/04-12/12	- SS	DSN3001	12	1.1
1.4	Petrol	59	FXJA;FXJB;FXJC		08/02-12/12		DSN3001	12	1.1
1.4 LPG	Petrol/ Liquified Petroleum Gas (LPG)	59	UTJA		01/10-12/12		DSN3001	12	1.1
1.6	Petrol	74	FYJA;FYJB;FYJC		08/02-11/09		DSN3001	12	1.1
Grand C-MAX (10-)									
1.6 Ti	Petrol	77/92	IQDA;IQDB;PNDA; PNDD		12/10-		DSN3001	12	1.1
KA (96-08)									
1.3	Petrol	51	A9A;A9B		10/02-03/04		DSN3002	12	1.1
1.3 i	Petrol	36/44	BAA;J4D;J4K;J4M; J4N;J4P;J4S;JJB; JJD;JF;JJG;JJH; JJJ		09/96-10/02		DSN3003	12	1.1
1.3 i	Petrol	36/44/51	A9A;A9B;BAA;J4D; J4K;J4M;J4N;J4P;J4S; JJD;JF;JJG;JJH; JJJ		10/02-11/08		DSN3002	12	1.1
1.6 i	Petrol	70	CDB;CDC		02/01-11/08	- SS	DSN3002	12	1.1
KA+ (16-)									
1.2	Petrol	51/63	B2KA;YSKD;YSKE		06/16-		DSN3001	12	1.1
1.2 Ti-VCT	Petrol	63	YSKD;YSKE		06/16-		DSN3001	12	1.1
MONDEO IV (07-15)									
1.6 Ti	Petrol	81/88/92	KGBA;PNBA;RHBA		03/07-01/15		DSN3001	12	1.1
STREET KA (03-05)									
1.6	Petrol	70	CDRA;CDRB		05/03-07/05	- SS	DSN3002	12	1.1
TOURNEO Custom (12-)									
2.2 TDCi	Diesel	92	CYFF	MTM	04/12-12/15		DSN3012	12	2
TRANSIT (06-14)									
2.2 TDCi	Diesel	63/81/85/96	P8FA;P8FB;QVFA; QWFA;SRFA;SRFB; SRFC;SRFD;SRFE		04/06-08/14		DSN3012	12	2
2.2 TDCi	Diesel	74	DRFA;DRFB;DRFC; DRFD;DRFE	MTM	10/11-08/14		DSN3004	12	1.4
2.2 TDCi	Diesel	103	UHFA;UHFB;UHFC	MTM	10/07-08/14		DSN3012	12	2
2.4 TDCi	Diesel	74/85	JXFA;JXFC;PHFA; PHFC		04/06-08/14		DSN3012	12	2
2.4 TDCi	Diesel	103	H9FD		04/06-08/14	- SS	DSN3012	12	2
2.4 TDCi 4x4	Diesel	103	H9FB		11/06-08/14	- SS	DSN3012	12	2
2.4 TDCi RWD	Diesel	74/85	JXFA;JXFC;PHFA; PHFC		04/06-08/14		DSN3012	12	2
2.4 TDCi RWD	Diesel	103	H9FB;H9FD		04/06-08/14	- SS	DSN3012	12	2
3.2 TDCi	Diesel	147	SAFA;SAFB		02/08-08/14		DSN3012	12	2
3.2 TDCi RWD	Diesel	147	SAFA;SAFB		09/07-08/14		DSN3012	12	2
TRANSIT Custom (12-)									
2.2 TDCi	Diesel	74/92	CYFF;DRF4;DRFF;DRFG	MTM	04/12-12/15		DSN3012	12	2
TRANSIT Tourneo (06-14)									
2.2 TDCi	Diesel	81/85/96	QVFA;QWFA;SRFA; SRFB;SRFC;SRFD; SRFE		07/06-08/14		DSN3012	12	2
HONDA									
ACCORD V (93-98)									
2.0 TDi	Diesel	77	20T2N		04/96-10/98		DSN604	12	2.0
ACCORD VII (03-08)									
2.0	Petrol	114	K20A6		02/03-05/08		DSN1406	12	1
2.0 4WD	Petrol	114	K20A6		02/03-05/08		DSN1406	12	1
2.4	Petrol	140	K24A3	6MTM	02/03-05/08		DSN1406	12	1
ACCORD VIII (08-)									
2.0 i	Petrol	115	R20A3	ATM	06/08-06/15		DSN1391	12	1.2
2.0 i	Petrol	115	R20A3	MTM	06/08-06/15		DSN1390	12	1.2
2.2 i-DTEC	Diesel	110/132	N22B1;N22B2	5ATM	07/08-		DSN1386	12	2.0
2.2 i-DTEC	Diesel	110/132	N22B1;N22B2	6MTM	07/08-		DSN1387	12	1.8
CITY (08-)									
1.4 i-VTEC	Petrol	73	L13Z1		09/08-		DSN1385	12	1
CIVIC VI (94-01)									
2.0 i D	Diesel	77	20T2N		04/98-11/00		DSN604	12	2.0









											
HONDA continued											
CIVIC VII (00-05)											
2.0 i Sport	Petrol	118	K20A3			09/01-09/05			DSN1389	12	1
2.0 Type-R	Petrol	147	K20A2			09/01-09/05			DSN1408	12	1
CIVIC VIII Hatchback (05-)											
1.4	Petrol	61	L13A7			09/05-			DSN1398	12	0.7
1.4	Petrol	73	L13Z1			10/08-			DSN1385	12	1
1.8	Petrol	103	R18A2			09/05-			DSN1391	12	1.2
CIVIC VIII Saloon (05-)											
1.6	Petrol	92	R16A1			09/05-			DSN1391	12	1.2
1.8	Petrol	103	R18A1;R18A2			09/05-02/12			DSN1391	12	1.2
CR-V II (01-06)											
2.0	Petrol	110	K20A4			09/01-03/07			DSN1389	12	1
2.4 VTEC 4WD	Petrol	118	K24A1			09/01-09/06			DSN1389	12	1
CR-V III (06-)											
2.0 i-VTEC 4WD	Petrol	110	R20A1;R20A2	ATM		10/06-06/12			DSN1391	12	1.2
2.0 i-VTEC 4WD	Petrol	110	R20A1;R20A2	MTM		10/06-06/12			DSN1390	12	1.2
2.2 i-DTEC 4WD	Diesel	110	N22B3	5ATM		01/10-			DSN1386	12	2.0
2.2 i-DTEC 4WD	Diesel	110	N22B3	6MTM		01/10-			DSN1387	12	1.8
CR-V IV (12-)											
2.2 i-DTEC 4WD	Diesel	110	N22B4	5ATM		10/12-			DSN1386	12	2.0
FR-V (04-)											
1.8	Petrol	103	R18A1			01/07-			DSN1391	12	1.2
2.0	Petrol	110	K20A9			02/05-			DSN1389	12	1
JAZZ II (02-08)											
1.2 i-DSI	Petrol	57	L12A1;L12A4			01/06-07/08			DSN1398	12	0.7
1.3	Petrol	61	L13A1			01/06-07/08			DSN1398	12	0.7
1.4 i-DSI	Petrol	61	L13A5;L13A6			12/06-10/08			DSN1398	12	0.7
JAZZ III (08-)											
1.2	Petrol	66	L12B1			07/08-			DSN1385	12	1
1.3 i	Petrol	73	L13Z1;L13Z2			07/08-			DSN1385	12	1
1.4	Petrol	74	L13Z1			11/08-			DSN1385	12	1
STREAM (01-06)											
2.0 16V	Petrol	115	K20A1;K20A5			05/01-09/06			DSN1389	12	1
ISUZU											
RODEO (97-04)											
3.2 V6 4WD	Petrol	151	6VD1 (DOHC)			09/97-08/04			DSN1488	12	1.4
TFR / TFS (88-02)											
3.5	Petrol	158	6VE1			09/95-12/02			DSN1488	12	1.4
3.5 4WD	Petrol	158	6VE1			09/95-12/02			DSN1488	12	1.4
TROOPER II (91-98)											
3.2	Petrol	130	6VD1 (SOHC)			08/91-07/98			DSN1488	12	1.4
TROOPER III (98-04)											
3.5 V6 24V	Petrol	158	6VE1			04/00-08/04			DSN1488	12	1.4
3.5 V6 24V AWD	Petrol	158	6VE1			04/00-08/04			DSN1488	12	1.4
VEHICROSS (97-00)											
3.2 4x4	Petrol	158	6VD1 (DOHC)			04/97-12/00			DSN1488	12	1.4
WIZARD (98-02)											
3.2 4x4	Petrol	158	6VD1 (DOHC)			06/98-08/02			DSN1488	12	1.4
JAGUAR											
F-PACE (15-)											
2.0 SD4 AWD	Diesel	177	204DTA	ATM		02/17-	+ SS		DSN1425	12	1.9
2.0 SD4 AWD	Diesel	177	204DTA	MTM		02/17-	+ SS		DSN1424	12	1.9
2.0 TD4	Diesel	120/132	204DTD	ATM		09/15-	+ SS		DSN1425	12	1.9
2.0 TD4	Diesel	120/132	204DTD	MTM		09/15-	+ SS		DSN1424	12	1.9
2.0 TD4 AWD	Diesel	132	204DTD	ATM		09/15-	+ SS		DSN1425	12	1.9
2.0 TD4 AWD	Diesel	132	204DTD	MTM		09/15-	+ SS		DSN1424	12	1.9
3.0 SCV6 AWD	Petrol	250/280	306PS			09/15-			DSN1410	12	1.7
F-TYPE (12-)											
3.0 SCV6	Petrol	250	306PS			10/12-	Ch No: >K15251;+ SS		DSN1412	12	1.7
3.0 SCV6	Petrol	250	306PS			10/12-	Ch No: K15252>;+ SS		DSN1410	12	1.7
3.0 SCV6 400 SPORT	Petrol	294	306PS			11/16-	+ SS		DSN1410	12	1.7
3.0 SCV6 400 SPORT AWD	Petrol	294	306PS			11/16-	+ SS		DSN1410	12	1.7
3.0 SCV6 S	Petrol	280	306PS			10/12-	Ch No: >K15251;+ SS		DSN1412	12	1.7
3.0 SCV6 S	Petrol	280	306PS			10/12-	Ch No: K15252>;+ SS		DSN1410	12	1.7
3.0 SCV6 S AWD	Petrol	280	306PS			12/14-	Ch No: >K15251;+ SS		DSN1412	12	1.7
3.0 SCV6 S AWD	Petrol	280	306PS			12/14-	Ch No: K15252>;+ SS		DSN1410	12	1.7
5.0 SCV8 R	Petrol	405	508PS			10/13-	Ch No: >K22184;+ SS		DSN1412	12	1.7
5.0 SCV8 R	Petrol	405	508PS			10/13-	Ch No: K22185>;+ SS		DSN1410	12	1.7
5.0 SCV8 R AWD	Petrol	405	508PS			12/14-	Ch No: >K22184;+ SS		DSN1412	12	1.7











										
JAGUAR continued										
F-TYPE (12-) continued										
5.0 SCV8 R AWD	Petrol	405	508PS		12/14-		Ch No: K22185>;+ SS	DSN1410	12	1.7
5.0 SCV8 S	Petrol	364	508PS		10/12-		Ch No: >K22184>;+ SS	DSN1412	12	1.7
5.0 SCV8 S	Petrol	364	508PS		10/12-		Ch No: K22185>;+ SS	DSN1410	12	1.7
5.0 SCV8 SVR / SCV8 P575 R	Petrol	423	508PS;AJ133G2		12/15-		Ch No: >K22184>;+ SS	DSN1412	12	1.7
5.0 SCV8 SVR / SCV8 P575 R	Petrol	423	508PS;AJ133G2		12/15-		Ch No: K22185>;+ SS	DSN1410	12	1.7
5.0 SCV8 SVR / SCV8 P575 R AWD	Petrol	423	508PS;AJ133G2		12/15-		Ch No: >K22184>;+ SS	DSN1412	12	1.7
5.0 SCV8 SVR / SCV8 P575 R AWD	Petrol	423	508PS;AJ133G2		12/15-		Ch No: K22185>;+ SS	DSN1410	12	1.7
S-TYPE (99-08)										
2.7 D	Diesel	152	AJD		06/04-10/07			DSN1300	12	2
4.0 V8	Petrol	203	AJ-V8		01/99-04/02			DSN605	12	1.4
4.2 R	Petrol	291	AJ-V8		04/02-10/07			DSN605	12	1.4
4.2 V8	Petrol	219	AJ-V8		04/02-10/07			DSN605	12	1.4
XE (15-)										
2.0	Petrol	147/177	204PT		03/15-			DSN1411	12	1.7
2.0 D	Diesel	120/132	204DTD	ATM	03/15-	+ SS		DSN1425	12	1.9
2.0 D	Diesel	120/132	204DTD	MTM	03/15-	+ SS		DSN1424	12	1.9
2.0 D AWD	Diesel	132/177	204DTA;204DTD	ATM	10/15-	+ SS		DSN1425	12	1.9
2.0 D AWD	Diesel	132/177	204DTA;204DTD	MTM	10/15-	+ SS		DSN1424	12	1.9
3.0 S	Petrol	250/280	306PS		03/15-			DSN1410	12	1.7
XF (08-15)										
2.7 D	Diesel	152	AJD		03/08-04/15			DSN1300	12	2
3.0	Petrol	250	306PS		03/12-04/15	+ SS		DSN1412	12	1.7
3.0 AWD	Petrol	250	306PS		10/12-04/15	+ SS		DSN1412	12	1.7
3.0 D	Diesel	155/177/ 202	306DT;AJV6D		03/09-04/15	- SS		DSN1300	12	2
5.0	Petrol	283	508PN		03/09-04/15			DSN1383	12	1.8
5.0 Kompressor	Petrol	346/375	508PS		01/09-04/15	Ch No: >S61361		DSN1383	12	1.8
5.0 Kompressor	Petrol	346/375	508PS		01/09-04/15	Ch No: S61362>;+ SS		DSN1412	12	1.7
5.0 XFR-S	Petrol	405	508PS		10/12-04/15	+ SS		DSN1412	12	1.7
XF (15-)										
2.0	Petrol	177	204PT		05/15-			DSN1411	12	1.7
2.0 D	Diesel	120/132/ 177	204DTA;204DTD	ATM	05/15-	+ SS		DSN1425	12	1.9
2.0 D	Diesel	120/132/ 177	204DTA;204DTD	MTM	05/15-	+ SS		DSN1424	12	1.9
2.0 D AWD	Diesel	132/177	204DTA;204DTD	ATM	03/16-	+ SS		DSN1425	12	1.9
2.0 D AWD	Diesel	132/177	204DTA;204DTD	MTM	03/16-	+ SS		DSN1424	12	1.9
3.0	Petrol	250/280	306PS		05/15-			DSN1410	12	1.7
3.0 AWD	Petrol	250/280	306PS		07/15-			DSN1410	12	1.7
XJ (97-03)										
3.2	Petrol	174	AJ-V8		07/97-05/03			DSN605	12	1.4
4.0	Petrol	209/267	AJ-V8		07/97-05/03			DSN605	12	1.4
XJ (03-09)										
4.2	Petrol	219	AJ-V8		05/03-03/09			DSN605	12	1.4
4.2 R	Petrol	291	AJ-V8		03/03-03/09			DSN605	12	1.4
D 2.7	Diesel	152	AJD		10/05-03/09			DSN1300	12	2
XJ (09-)										
3.0 SCV6	Petrol	250	306PS		03/12-	Ch No: V39427>V90865; + SS		DSN1412	12	1.7
3.0 SCV6	Petrol	250	306PS		03/12-	Ch No: V90866>;+ SS		DSN1410	12	1.7
3.0 SCV6 AWD	Petrol	250	306PS		10/12-	Ch No: V39427>V90865; + SS		DSN1412	12	1.7
3.0 SCV6 AWD	Petrol	250	306PS		10/12-	Ch No: V90866>;+ SS		DSN1410	12	1.7
3.0 SDV6	Diesel	202	306DT		10/09-04/16	- SS		DSN1300	12	2
5.0 SCV8	Petrol	346/375	508PS		10/09-	Ch No: >V39426		DSN1383	12	1.8
5.0 SCV8	Petrol	346/375/ 405	508PS		10/09-	Ch No: V39427>V90865; + SS		DSN1412	12	1.7
5.0 SCV8	Petrol	346/375/ 405	508PS		10/09-	Ch No: V90866>;+ SS		DSN1410	12	1.7
5.0 SCV8 R575	Petrol	423	508PS		06/17-	+ SS		DSN1410	12	1.7
5.0 V8	Petrol	283	508PN		10/09-	Ch No: >V39426		DSN1383	12	1.8
5.0 V8	Petrol	283	508PN		10/09-	Ch No: V39427>;+ SS		DSN1412	12	1.7
XK 8 (96-05)										
4.0	Petrol	209/216/ 267	AJ-V8		03/96-07/05			DSN605	12	1.4
4.0 XKR	Petrol	276	AJ-V8		05/98-07/05			DSN605	12	1.4
4.2	Petrol	219	AJ-V8		08/02-12/06			DSN605	12	1.4
4.2 R	Petrol	291	AJ-V8		08/02-12/06			DSN605	12	1.4
XK (06-14)										
4.2 XK8	Petrol	219	AJ-V8		03/06-07/14			DSN605	12	1.4

									
JAGUAR continued									
XK (06-14) continued									
4.2 XKR	Petrol	291/306	AJ-V8		03/06-07/14		DSN605	12	1.4
5.0 V8	Petrol	283	508PN		01/09-07/14		DSN1383	12	1.8
5.0 XKR	Petrol	375/390	508PS		01/09-07/14		DSN1383	12	1.8
5.0 XKR-S	Petrol	405	508PS		01/11-07/14		DSN1383	12	1.8
LANCIA									
DEDRA (89-99)									
1.8 16V LE	Petrol	83	182 A2.000	MTM	03/96-10/98		DSN579	12	1.4
1.8 GT 16V	Petrol	96	183 A1.000	MTM	03/96-07/99		DSN579	12	1.4
DELTA II (93-99)									
1.6 i.e.	Petrol	66	182 A6.000	MTM	03/96-08/99		DSN577	12	1.0
1.6 i.e. 16V	Petrol	76	182 A4.000	MTM	01/96-08/99		DSN577	12	1.0
1.6 i.e. 16V	Petrol	76	182 A4.000	MTM	01/96-08/99		DSN579	12	1.4
1.8 i.e. 16V	Petrol	83	182 A2.000	MTM	03/96-04/98		DSN577	12	1.0
1.8 i.e. 16V GT	Petrol	96	183 A1.000	MTM	03/96-08/99		DSN579	12	1.4
DELTA III (08-14)									
1.6 D Multijet	Diesel	77/85/88	198 A2.000; 944 A 3.000;955 A4.000		08/08-08/14	- SS	DSN3018	12	2
1.8	Petrol	147	939 B1.000		01/09-08/14		DSN3018	12	2
2.0 D Multijet	Diesel	121	198 A5.000	ATM	09/08-08/14		DSN3018	12	2
KAPPA (94-01)									
2.0 20V	Petrol	107	838 A1.000	MTM	10/94-10/01		DSN579	12	1.4
2.0 20V	Petrol	114	838 A6.000		07/96-10/01		DSN579	12	1.4
2.0 20V Turbo	Petrol	162	175 A3.000		06/98-10/01		DSN579	12	1.4
2.4 20V	Petrol	129	838 A2.000		07/96-10/01		DSN579	12	1.4
2.4 20V	Petrol	129	838 A2.000;838 A2.027	MTM	08/94-10/01		DSN579	12	1.4
LYBRA (99-05)									
1.8 16V	Petrol	96	839 A7.000		07/99-10/05		DSN579	12	1.4
1.9 JTD	Diesel	77/81/85	937 A2.000;AR 32302; AR 37101		07/99-10/05		DSN3018	12	2
2.0 20V	Petrol	110	185 A8.000	MTM	09/00-07/02		DSN579	12	1.4
2.0 20V	Petrol	113	182 B7.000		07/99-09/00		DSN579	12	1.4
2.4 20V	Petrol	125	192 A2.000		10/01-10/05		DSN3018	12	2
2.4 JTD	Diesel	99/103/ 110	839 A5.000;839 A6.000; 841 C.000		07/99-10/05		DSN3018	12	2
MUSA (04-12)									
1.4	Petrol	57	350 A1.000		09/05-09/12		DSN3018	12	2
1.4 LPG	Petrol/ Liquified Petroleum Gas (LPG)	57	350 A1.000		11/10-09/12		DSN3018	12	2
1.6 D Multijet	Diesel	85/88	350 A2.000;350 A3.000		07/08-09/12	- SS	DSN3018	12	2
1.9 D Multijet	Diesel	74	188 B2.000		10/04-09/12		DSN3018	12	2
PHEDRA (02-10)									
2.0	Petrol	100	RFN (EW10J4)		09/02-11/10		DSN3004	12	1.4
THESIS (02-09)									
2.0 Turbo	Petrol	136	841 E.000		07/02-07/09		DSN579	12	1.4
2.4	Petrol	125	841 D.000		07/02-08/06		DSN579	12	1.4
2.4 D Multijet	Diesel	136	841 P.000		04/06-07/09		DSN3018	12	2
2.4 JTD	Diesel	110/120/ 129	841 C.000;841 G.000; 841 M.000;841 N.000		07/02-07/09		DSN3018	12	2
YPSILON (312/846) (11-)									
0.9 CNG	Petrol/ Compressed Natural Gas (CNG)	63	312 A2.000		05/11-		DSN975	12	1.4
0.9 TwinAir	Petrol	59	312 A2.000;312 A5.000		12/13-		DSN975	12	1.4
0.9 TwinAir	Petrol	63	312 A2.000		05/11-	BO	DSN975	12	1.4
YPSILON (843) (03-11)									
1.4	Petrol	57	350 A1.000		02/06-12/11		DSN3018	12	2
1.4 LPG	Petrol/ Liquified Petroleum Gas (LPG)	57	350 A1.000		11/10-12/11		DSN3018	12	2

			 kW				 NOTE			kW
LAND ROVER										
DEFENDER (90-16)										
2.2 Td4 4x4	Diesel	90/110	DT224		08/11-02/16	- SS		DSN3012	12	2
2.4 Td4 4x4	Diesel	90/103	DT244		10/06-02/16	- SS		DSN3012	12	2
2.5 Td5 4x4	Diesel	90	10 P;14 P		06/98-04/07			DSN600	12	2.0
DISCOVERY II (98-04)										
2.5 Td5 4x4	Diesel	102	10 P;15 P		11/98-06/04			DSN600	12	2.0
DISCOVERY III (04-09)										
2.7 TD 4x4	Diesel	140	276DT		07/04-09/09			DSN944	12	2
DISCOVERY IV (09-18)										
2.7 TD 4x4	Diesel	140	276DT		09/09-12/18			DSN944	12	2
3.0 4x4	Petrol	250	306PS		08/13-12/18	- SS		DSN1419	12	1.4
3.0 4x4	Petrol	250	306PS		08/13-12/18	+ SS		DSN1415	12	1.9
3.0 SDV6 4x4	Diesel	188	306DT		11/09-12/18	- SS		DSN976	12	2
3.0 SDV6 4x4	Diesel	188	306DT		11/09-12/18	+ SS		DSN1418	12	1.9
3.0 TD 4x4	Diesel	155/180/183/200	306DT		09/09-12/18	- SS		DSN976	12	2
3.0 TD 4x4	Diesel	155/180/183/200	306DT		09/09-12/18	+ SS		DSN1418	12	1.9
5.0 V8 4x4	Petrol	276	508PN		09/09-12/18			DSN1364	12	1.4
DISCOVERY Sport (14-)										
2.0 4x4	Petrol	177	204PT	9ATM	11/14-	- SS		DSN1384	12	1.3
2.0 4x4	Petrol	177	204PT	9ATM	11/14-	+ SS		DSN1411	12	1.7
2.0 D	Diesel	110	204DTD	ATM	08/15-	+ SS		DSN1423	12	1.9
2.0 D	Diesel	110	204DTD	MTM	08/15-	+ SS		DSN1422	12	1.9
2.0 D 4x4	Diesel	110/132/177	204DTA;204DTD	ATM	12/14-	+ SS		DSN1423	12	1.9
2.0 D 4x4	Diesel	110/132/177	204DTA;204DTD	MTM	12/14-	+ SS		DSN1422	12	1.9
2.2 D 4x4	Diesel	110/140	224DT	6MTM	09/14-			DSN1208	12	2
2.2 D 4x4	Diesel	110/140	224DT	9ATM	09/14-	- SS		DSN1209	12	2
2.2 D 4x4	Diesel	110/140	224DT	9ATM	09/14-	+ SS		DSN1365	12	1.9
DISCOVERY V (16-)										
3.0 D 4x4	Diesel	155/183	306DT		09/16-	- SS		DSN976	12	2
3.0 D 4x4	Diesel	155/183	306DT		09/16-	+ SS		DSN1417	12	1.9
3.0 SCV6 4x4	Petrol	250	306PS		09/16-	- SS		DSN1419	12	1.4
3.0 SCV6 4x4	Petrol	250	306PS		09/16-	+ SS		DSN1416	12	1.9
3.0 Td6 4x4	Diesel	190	306DT		09/16-	- SS		DSN976	12	2
3.0 Td6 4x4	Diesel	190	306DT		09/16-	+ SS		DSN1417	12	1.9
FREELANDER I (98-06)										
1.8 16V 4x4	Petrol	86	18 K4F	5MTM	04/98-10/06			DSN602	12	1
1.8 i 16V 4x4	Petrol	88	18 K4F		02/98-10/06			DSN602	12	1
2.0 DI 4x4	Diesel	72	20 T2N		02/98-11/00			DSN604	12	2.0
2.0 Td4 4x4	Diesel	80	M47R		03/01-10/06			DSN601	12	2.0
2.0 Td4 4x4	Diesel	82	M47R		11/00-10/06	Ch No: 1A000001>		DSN601	12	2.0
2.5 V6 4x4	Petrol	130	25 K4F	ATM	11/00-10/06			DSN603	12	2.0
FREELANDER II (06-14)										
2.0 P240 Si4 4x4	Petrol	177	204PT	6ATM	10/11-10/14			DSN1384	12	1.3
2.2 eD4	Diesel	110	224DT;DW12BTED4	MTM	08/10-10/14			DSN1208	12	2
2.2 SD4 4x4	Diesel	140	224DT	ATM	08/10-10/14			DSN1209	12	2
2.2 TD4 4x4	Diesel	110/112/115/118	224DT;DW12BTED4	ATM	10/06-10/14			DSN1209	12	2
2.2 TD4 4x4	Diesel	110/112/115/118	224DT;DW12BTED4	MTM	10/06-10/14			DSN1208	12	2
RANGE ROVER Evoque (11-19)										
2.0 4x4	Petrol	177	204PT	6ATM	06/11-12/19			DSN1384	12	1.3
2.0 4x4	Petrol	177	204PT	9ATM	06/11-12/19	- SS		DSN1384	12	1.3
2.0 4x4	Petrol	177	204PT	9ATM	06/11-12/19	Ch No: GH000001>;+ SS		DSN1411	12	1.7
2.0 4x4	Petrol	177	204PT	9ATM	11/15-12/19	+ SS		DSN1411	12	1.7
2.0 D	Diesel	110	204DTD	ATM	06/15-12/19	+ SS		DSN1423	12	1.9
2.0 D	Diesel	110	204DTD	MTM	06/15-12/19	+ SS		DSN1422	12	1.9
2.0 D 4x4	Diesel	110/132/177	204DTA;204DTD	ATM	05/15-12/19	+ SS		DSN1423	12	1.9
2.0 D 4x4	Diesel	110/132/177	204DTA;204DTD	MTM	05/15-12/19	+ SS		DSN1422	12	1.9
2.2 D	Diesel	110	224DT	6MTM	06/11-12/19			DSN1208	12	2
2.2 D 4x4	Diesel	110/140	224DT	6ATM	06/11-12/19			DSN1209	12	2
2.2 D 4x4	Diesel	110/140	224DT	6MTM	06/11-12/19			DSN1208	12	2
2.2 D 4x4	Diesel	110/140	224DT	9ATM	06/11-12/19	- SS		DSN1209	12	2
2.2 D 4x4	Diesel	110/140	224DT	9ATM	06/11-12/19	+ SS		DSN1365	12	1.9

									
LAND ROVER continued									
RANGE ROVER III (02-12)									
3.6 D 4x4	Diesel	200	368DT		04/06-08/12		DSN1207	12	2.7
4.4 D 4x4	Diesel	230	448DT		07/10-08/12		DSN1207	12	2.7
5.0 4x4	Petrol	276/375	508PN;508PS		09/09-08/12		DSN1364	12	1.4
RANGE ROVER IV (12-)									
3.0 SCV6 4x4	Petrol	250	306PS		10/13-06/15	Ch No: >EA999999;+ SS	DSN1415	12	1.9
3.0 SCV6 4x4	Petrol	250	306PS		06/15-	Ch No: FA000001>;+ SS	DSN1416	12	1.9
3.0 SCV6 4x4	Petrol	250/280	306PS		10/13-	- SS	DSN1419	12	1.4
3.0 SCV6 4x4	Petrol	280	306PS		06/15-	+ SS	DSN1416	12	1.9
3.0 SDV6 4x4	Diesel	183	306DT		08/12-	- SS	DSN976	12	2
3.0 SDV6 4x4	Diesel	183	306DT		08/12-	+ SS	DSN1418	12	1.9
3.0 SDV6 4x4	Diesel	183	306DT		08/12-	Ch No: FA000001>;+ SS	DSN1417	12	1.9
3.0 SDV6 Hybrid 4x4	Diesel/ Electro	215/225/ 250	306DT		10/13-	+ SS	DSN1418	12	1.9
3.0 TDV6 4x4	Diesel	155/190	306DT		08/12-	- SS	DSN976	12	2
3.0 TDV6 4x4	Diesel	155/190	306DT		08/12-	+ SS	DSN1418	12	1.9
3.0 TDV6 4x4	Diesel	155/190	306DT		08/12-	Ch No: FA000001>;+ SS	DSN1417	12	1.9
4.4 SDV8 4x4	Diesel	250	448DT		08/12-	- SS	DSN1420	12	2.7
4.4 SDV8 4x4	Diesel	250	448DT		08/12-	+ SS	DSN1421	12	2.7
5.0 SCV8 4x4	Petrol	375	508PS		08/12-06/15	Ch No: >EA999999;+ SS	DSN1415	12	1.9
5.0 SCV8 4x4	Petrol	375	508PS		06/15-	Ch No: FA000001>;+ SS	DSN1416	12	1.9
5.0 SCV8 4x4	Petrol	375/405	508PS		08/12-	- SS	DSN1419	12	1.4
5.0 SCV8 4x4	Petrol	405	508PS		06/15-	+ SS	DSN1416	12	1.9
5.0 V8 4x4	Petrol	276	508PN		12/13-	- SS	DSN1419	12	1.4
5.0 V8 4x4	Petrol	276	508PN		12/13-	+ SS	DSN1415	12	1.9
RANGE ROVER Sport (05-13)									
2.7 D 4x4	Diesel	140	276DT		02/05-03/13		DSN944	12	2
3.0 D 4x4	Diesel	155/180/ 183/188	306DT		09/09-03/13		DSN976	12	2
3.6 D 4x4	Diesel	200	368DT		04/06-03/13		DSN1207	12	2.7
5.0 4x4	Petrol	276/372/ 375	508PN;508PS		04/09-03/13		DSN1364	12	1.4
RANGE ROVER Sport (13-)									
3.0 SCV6 4x4	Petrol	250	306PS		04/13-06/15	Ch No: >EA999999;+ SS	DSN1415	12	1.9
3.0 SCV6 4x4	Petrol	250	306PS		06/15-12/19	Ch No: FA000001>;+ SS	DSN1416	12	1.9
3.0 SCV6 4x4	Petrol	250/280	306PS		04/13-12/19	- SS	DSN1419	12	1.4
3.0 SCV6 4x4	Petrol	280	306PS		06/15-12/18	+ SS	DSN1416	12	1.9
3.0 SDV6 4x4	Diesel	183/215/ 225	306DT		04/13-	- SS	DSN976	12	2
3.0 SDV6 4x4	Diesel	183/215/ 225	306DT		04/13-	+ SS	DSN1418	12	1.9
3.0 SDV6 4x4	Diesel	183/215/ 225	306DT		04/13-	Ch No: FA000001>;+ SS	DSN1417	12	1.9
3.0 SDV6 Hybrid 4x4	Diesel/ Electro	215/225/ 250	306DT		10/13-	+ SS	DSN1418	12	1.9
3.0 TDV6 4x4	Diesel	155/190	306DT		04/13-	- SS	DSN976	12	2
3.0 TDV6 4x4	Diesel	155/190	306DT		04/13-	+ SS	DSN1418	12	1.9
3.0 TDV6 4x4	Diesel	155/190	306DT		04/13-	Ch No: FA000001>;+ SS	DSN1417	12	1.9
4.4 SDV8 4x4	Diesel	250	448DT		10/13-	- SS	DSN1420	12	2.7
4.4 SDV8 4x4	Diesel	250	448DT		10/13-	+ SS	DSN1421	12	2.7
5.0 SCV8 4x4	Petrol	375/405	508PS		04/13-06/15	Ch No: >EA999999;+ SS	DSN1415	12	1.9
5.0 SCV8 4x4	Petrol	375/405	508PS		04/13-12/18	- SS	DSN1419	12	1.4
5.0 SCV8 4x4	Petrol	375/405	508PS		06/15-12/18	Ch No: FA000001>;+ SS	DSN1416	12	1.9
LEXUS									
ES (12-18)									
250	Petrol	135	2AR-FE		06/12-06/18		DSN1003	12	1.7
350	Petrol	204	2GR-FE		06/12-06/18		DSN1003	12	1.7
GS (97-05)									
430	Petrol	208	3UZ-FE		11/00-12/04		DSN1223	12	2
GS (05-11)									
300	Petrol	183	3GR-FSE		04/05-11/11		DSN1256	12	1.7
350 AWD	Petrol	226	2GR-FSE		09/06-11/11		DSN1256	12	1.7
430	Petrol	208	3UZ-FE		04/05-09/08		DSN1223	12	2
460	Petrol	255	1UR-FSE		09/07-11/11		DSN1222	12	2
GS (12-)									
250	Petrol	154	4GR-FSE		01/12-		DSN1256	12	1.7
350 AWD	Petrol	234	2GR-FSE		12/11-		DSN1256	12	1.7
GX (09-)									
470	Petrol	218	1UR-FE		01/10-		DSN1236	12	2
IS C (09-15)									
250	Petrol	153	4GR-FSE		04/09-06/15		DSN1256	12	1.7

			 kW				 NOTE			kW
LEXUS continued										
IS I (99-05)										
200	Petrol	114	1G-FE		04/99-07/05			DSN999	12	1
IS II (05-13)										
5.0 IS F	Petrol	311	2UR-GSE		11/07-03/13			DSN1222	12	2
200d	Diesel	110	2AD-FTV		07/10-08/12			DSN984	12	2
220d	Diesel	130	2AD-FHV		08/05-08/12			DSN984	12	2
250	Petrol	153	4GR-FSE		08/05-03/13			DSN1256	12	1.7
250 AWD	Petrol	158	4GR-FSE		11/10-03/13			DSN1256	12	1.7
IS III (13-)										
250	Petrol	153	4GR-FSE		04/13-			DSN1256	12	1.7
LS (00-06)										
430	Petrol	207	3UZ-FE		08/00-08/06			DSN1223	12	2
LS (06-17)										
460	Petrol	255/280/ 283	1UR-FE;1UR-FSE		04/06-09/12			DSN1222	12	2
RX (98-03)										
300	Petrol	148	1MZ-FE		01/98-02/03			DSN929	12	1.4
300 AWD	Petrol	148	1MZ-FE		01/98-02/03			DSN929	12	1.4
RX (03-08)										
3.3	Petrol	171	3MZ-FE		04/03-01/06			DSN1003	12	1.7
300	Petrol	150	1MZ-FE		05/03-01/06			DSN1003	12	1.7
330 AWD	Petrol	171	3MZ-FE		04/03-01/06			DSN1003	12	1.7
350 AWD	Petrol	203	2GR-FE		02/06-12/08			DSN1003	12	1.7
RX (08-15)										
350 AWD	Petrol	204	2GR-FE;2GR-FXE		12/08-08/15			DSN1003	12	1.7
450h	Petrol/ Electric	183	2GR-FXE		12/08-10/15			DSN1003	12	1.7
450h AWD	Petrol/ Electric	183	2GR-FXE		12/08-10/15			DSN1003	12	1.7
SC (01-10)										
430	Petrol	210/215	3UZ-FE		01/01-07/10			DSN1223	12	2
MAN										
TGE (16-)										
2.0 TDI	Diesel	75/103/ 130	DAUA;DAUB;DAVA	Autom atic Transm ission, 8-spee d	11/16-	BO;VA		DSN1461	12	2.0
2.0 TDI AWD	Diesel	103/130	DAUA;DAVA	Autom atic Transm ission, 8-spee d	03/17-	BO;VA		DSN1461	12	2.0
MASERATI										
4200 GT (01-)										
4.2	Petrol	287	M 138		10/01-			DSN1457	12	1.4
GRANCABRIO (10-)										
4.7	Petrol	323/324	M 139 S		03/10-			DSN1457	12	1.4
GRANSPORT (03-)										
4.2	Petrol	295	M 138 P		06/04-			DSN1457	12	1.4
GRANTURISMO (08-)										
4.2	Petrol	298	M 139 P		09/07-			DSN1457	12	1.4
4.7 S	Petrol	323	M 139 S		08/08-12/12			DSN1457	12	1.4
QUATTROPORTE V (04-)										
4.2	Petrol	295/298	M 139 P;M139 A		03/04-			DSN1457	12	1.4
4.7 GT S	Petrol	323	M 139 L;M 139 S		06/08-			DSN1457	12	1.4
4.7 S	Petrol	317	M 139 R		06/08-			DSN1457	12	1.4
MAZDA										
2 (03-07)										
1.2	Petrol	55	FUJA		02/03-06/07	- SS		DSN3001	12	1.1
1.25	Petrol	55	FUJA		04/03-06/07	- SS		DSN3001	12	1.1
1.4	Petrol	59	FXJA		02/03-06/07			DSN3001	12	1.1
1.6	Petrol	74	FYJA		02/03-06/07			DSN3001	12	1.1
121 III (96-03)										
1.3	Petrol	44	J4R;J4T		03/96-04/03	- SS		DSN3003	12	1.1
MERCEDES-BENZ										
190 (W201) (82-93)										
E 2.6	Petrol	118/120	M 103.942		10/82-08/93			DSN3011	12	2.2
A-CLASS (W176) (12-18)										
A 45 AMG 4-matic	Petrol	265	M 133.980		06/13-05/18			DSN1206	12	1.7
A 160 CDI / d	Diesel	66	OM 607.951		06/13-05/18			DSN1206	12	1.7

									
MERCEDES-BENZ continued									
A-CLASS (W176) (12-18) continued									
A 180	Petrol	90	M 270.910		09/12-05/18		DSN1206	12	1.7
A 180 CDI / d 1.5	Diesel	80	OM 607.951		06/12-05/18		DSN1206	12	1.7
A 180 CDI / d 1.8	Diesel	80	OM 651.901		06/12-10/14		DSN1206	12	1.7
A 200	Petrol	115	M 270.910		06/12-05/18		DSN1206	12	1.7
A 200 CDI / d 1.8	Diesel	100	OM 651.901		06/12-10/14		DSN1206	12	1.7
A 200 CDI / d 2.1	Diesel	100	OM 651.930		02/14-05/18		DSN1206	12	1.7
A 200 CDI / d 2.1 4-matic	Diesel	100	OM 651.930		02/14-05/18		DSN1206	12	1.7
A 220 4-matic	Petrol	135	M 270.920		05/14-05/18		DSN1206	12	1.7
A 220 CDI	Diesel	120/125	OM 651.930		09/12-05/18		DSN1206	12	1.7
A 220 CDI 4-matic	Diesel	125	OM 651.930		02/14-05/18		DSN1206	12	1.7
A 250	Petrol	155	M 270.920		06/12-05/18		DSN1206	12	1.7
A 250 4-matic	Petrol	155	M 270.920		06/13-05/18		DSN1206	12	1.7
B-CLASS (W242, W246) (11-18)									
B 160 CDI / d	Diesel	66	OM 607.951		05/13-12/18		DSN1206	12	1.7
B 180	Petrol	90	M 270.910		11/11-12/18		DSN1206	12	1.7
B 180 CDI / d 1.5	Diesel	80	OM 607.951		02/13-12/18		DSN1206	12	1.7
B 180 CDI / d 1.8	Diesel	80	OM 651.901		11/11-08/14		DSN1206	12	1.7
B 200	Petrol	115	M 270.910		11/11-12/18		DSN1206	12	1.7
B 200 CDI / d 1.8	Diesel	100	OM 651.901		11/11-08/14		DSN1206	12	1.7
B 200 CDI / d 2.1	Diesel	100	OM 651.930		08/14-12/18		DSN1206	12	1.7
B 200 CDI / d 2.1 4-matic	Diesel	100	OM 651.930		08/14-12/18		DSN1206	12	1.7
B 200 Natural Gas Drive / B 200 c	Petrol/ Compressed Natural Gas (CNG)	115	M 270.920		11/12-12/17		DSN1206	12	1.7
B 220 4-matic	Petrol	135	M 270.920		05/13-12/18		DSN1206	12	1.7
B 220 CDI / d	Diesel	120/125/ 130	OM 651.930		11/11-12/18		DSN1206	12	1.7
B 220 CDI / d 4-matic	Diesel	130	OM 651.930		08/14-12/18		DSN1206	12	1.7
B 250	Petrol	155	M 270.920		05/12-12/18		DSN1206	12	1.7
B 250 4-matic	Petrol	155	M 270.920		08/14-12/18		DSN1206	12	1.7
CABRIOLET (A124) (92-93)									
300 CE / 320 CE	Petrol	162	M 104.992		10/92-05/93		DSN3011	12	2.2
300 CE-24	Petrol	162/170	M 104.980		04/92-06/93		DSN3011	12	2.2
C-CLASS (202) (93-01)									
C 36 AMG	Petrol	206	M 104.941 (AMG 3.6)		05/94-05/00		DSN3011	12	2.2
C 200 CDI	Diesel	75	OM 611.960		03/98-05/00		DSN3011	12	2.2
C 200 D	Diesel	55/65	OM 601.913;OM 604.915		03/93-05/00		DSN3011	12	2.2
C 200 T CDI	Diesel	75	OM 611.960		03/98-03/01		DSN3011	12	2.2
C 200 T D	Diesel	65	OM 604.915		10/96-03/01		DSN3011	12	2.2
C 220 CDI	Diesel	92	OM 611.960		09/97-05/00		DSN3011	12	2.2
C 220 D	Diesel	55/70	OM 604.910		08/93-05/00		DSN3011	12	2.2
C 220 T CDI	Diesel	92	OM 611.960		09/97-03/01		DSN3011	12	2.2
C 220 T D	Diesel	55/70	OM 604.910		06/96-03/01		DSN3011	12	2.2
C 250 D	Diesel	83	OM 605.910		05/93-05/00		DSN3011	12	2.2
C 250 T Turbo-D	Diesel	110	OM 605.960		06/96-03/01		DSN3011	12	2.2
C 250 Turbo-D	Diesel	110	OM 605.960		10/95-05/00		DSN3011	12	2.2
C 280	Petrol	142	M 104.941		05/93-05/00		DSN3011	12	2.2
C-CLASS (203) (00-07)									
C 180 Kompressor	Petrol	105	M 271.946		05/02-08/07		DSN3010	12	1.1
C 200 CDI	Diesel	75/85/90	OM 611.962; OM 646.962;OM 646.963		09/00-08/07		DSN3011	12	2.2
C 200 CDI	Diesel	75/90	OM 611.962; OM 646.962;OM 646.963		02/01-08/07		DSN968	12	1.8
C 200 CGI Kompressor	Petrol	125	M 271.942		07/03-08/07		DSN3010	12	1.1
C 200 Kompressor	Petrol	120	M 271.940		05/02-08/07		DSN3010	12	1.1
C 220 CDI	Diesel	100/105/ 110	OM 611.962;OM 646.963		05/00-08/07		DSN3011	12	2.2
C 220 CDI	Diesel	100/110	OM 646.963		09/06-08/07		DSN968	12	1.8
C 230 Kompressor	Petrol	141	M 271.948		02/04-08/07		DSN3010	12	1.1
C-CLASS (204) (07-14)									
C 180	Petrol	115	M 274.910		01/08-08/14		DSN1205	12	1.7
C 180 CDI	Diesel	88	OM 651.913		04/10-08/14		DSN967	12	1.8
C 180 CGI	Petrol	115	M 271.820		01/07-08/14		DSN3010	12	1.1
C 180 Kompressor	Petrol	115	M 271.910;M 271.952		01/07-08/14		DSN3010	12	1.1
C 200	Petrol	137	M 271.820		05/11-01/14		DSN3010	12	1.1



kW













kW

MERCEDÉS-BENZ continued									
C-CLASS (204) (07-14) continued									
C 200 CDI	Diesel	100	OM 646.811		01/07-12/09		DSN968	12	1.8
C 200 CDI	Diesel	100	OM 651.913		11/09-08/14		DSN967	12	1.8
C 200 CGI	Petrol	135	M 271.820;M 271.860		01/07-08/14		DSN3010	12	1.1
C 200 Kompressor	Petrol	135	M 271.950		01/07-08/14		DSN3010	12	1.1
C 220 CDI	Diesel	120/125	OM 646.811		01/07-11/08		DSN968	12	1.8
C 220 CDI	Diesel	125	OM 651.911		12/08-08/14		DSN967	12	1.8
C 220 CDI 4-matic	Diesel	125	OM 651.912		02/13-08/14		DSN967	12	1.8
C 250 CDI	Diesel	150	OM 651.911		08/08-08/14		DSN967	12	1.8
C 250 CDI 4-matic	Diesel	150	OM 651.912		04/10-08/14		DSN967	12	1.8
C 250 CGI	Petrol	150	M 271.860		07/09-08/14		DSN3010	12	1.1
C-CLASS (205) (13-)									
C 45 AMG 4-matic	Petrol	270	M 276.823		04/15-05/18		DSN1205	12	1.7
C 180	Petrol	115	M 274.910		03/14-		DSN1205	12	1.7
C 200	Petrol	135	M 274.920		12/13-08/18		DSN1205	12	1.7
C 250	Petrol	155	M 274.920		03/14-05/18		DSN1205	12	1.7
C-CLASS Coupe (C204) (11-)									
C 180	Petrol	115	M 271.820		06/11-		DSN3010	12	1.1
C 180	Petrol	115	M 274.910		01/13-		DSN1205	12	1.7
C 200 CGI	Petrol	135	M 271.860		06/11-		DSN3010	12	1.1
C 220 CDI	Diesel	120/125	OM 651.911		06/11-		DSN967	12	1.8
C 250	Petrol	150	M 271.860		06/11-		DSN3010	12	1.1
C 250 CDI	Diesel	150	OM 651.911		06/11-		DSN967	12	1.8
C-CLASS Coupe (CL203) (01-08)									
C 160 Kompressor	Petrol	90	M 271.921		05/02-05/08		DSN3010	12	1.1
C 180 Kompressor	Petrol	105	M 271.946		05/02-05/08		DSN3010	12	1.1
C 200 CDI	Diesel	90	OM 646.962		09/06-05/08		DSN968	12	1.8
C 200 CGI Kompressor	Petrol	125	M 271.942		03/03-05/08		DSN3010	12	1.1
C 200 Kompressor	Petrol	120	M 271.940		05/02-05/08		DSN3010	12	1.1
C 220	Petrol	120	M 271.940		05/02-05/08		DSN3010	12	1.1
C 220 CDI	Diesel	110	OM 646.963		09/06-05/08		DSN968	12	1.8
C 230 Kompressor	Petrol	141	M 271.948		05/02-05/08		DSN3010	12	1.1
C-CLASS Coupe / Convertible (205) (16-)									
C 43 AMG 4-matic	Petrol	270	M 276.823		04/16-05/18		DSN1205	12	1.7
C 180	Petrol	115	M 274.910		10/15-		DSN1205	12	1.7
CLA (117) (13-19)									
CLA 45 AMG 4-matic	Petrol	265/280	M 133.980		07/13-03/19		DSN1206	12	1.7
CLA 180	Petrol	90	M 270.910		01/13-03/19		DSN1206	12	1.7
CLA 180 CDI / d	Diesel	80	OM 607.951		10/13-05/18		DSN1206	12	1.7
CLA 200	Petrol	115	M 270.910		01/13-03/19		DSN1206	12	1.7
CLA 200 CDI / d 1.8	Diesel	100	OM 651.901		06/13-08/14		DSN1206	12	1.7
CLA 200 CDI / d 2.1	Diesel	100	OM 651.930		07/14-03/19		DSN1206	12	1.7
CLA 200 CDI / d 2.1	Diesel	100	OM 651.930	MTM	01/15-03/19		DSN1206	12	1.7
CLA 200 CDI / d 2.1 4-matic	Diesel	100	OM 651.930		07/14-03/19		DSN1206	12	1.7
CLA 220 4-matic	Petrol	135	M 270.920		04/16-03/19		DSN1206	12	1.7
CLA 220 CDI / d	Diesel	120/125/ 130	OM 651.930		01/13-03/19		DSN1206	12	1.7
CLA 220 CDI / d 4-matic	Diesel	120/125/ 130	OM 651.930		07/14-03/19		DSN1206	12	1.7
CLA 250	Petrol	155/160	M 270.920		01/13-03/19		DSN1206	12	1.7
CLA 250 4-matic	Petrol	155/160	M 270.920		07/13-03/19		DSN1206	12	1.7
CLC (CL203) (08-11)									
CLC 160	Petrol	95	M 271.911		02/09-06/11		DSN3010	12	1.1
CLC 180 Kompressor	Petrol	105	M 271.946		05/08-06/11		DSN3010	12	1.1
CLC 200 CDI	Diesel	90	OM 646.962		05/08-06/11		DSN968	12	1.8
CLC 200 Kompressor	Petrol	135	M 271.957		05/08-06/11		DSN3010	12	1.1
CLC 220 CDI	Diesel	110	OM 646.963		05/08-06/11		DSN968	12	1.8
CLK (209) (02-10)									
CLK 200 CGI	Petrol	125	M 271.942		07/03-05/09		DSN3010	12	1.1
CLK 200 Kompressor	Petrol	120/135	M 271.940;M 271.955		09/02-03/10		DSN3010	12	1.1
CLK 220 CDI	Diesel	100/110	OM 646.966		10/06-05/09		DSN968	12	1.8
CLK 220 CDI	Diesel	100/110	OM 646.966		10/06-05/09		DSN3011	12	2.2
CLS (218) (11-17)									
CLS 220 BlueTEC / d	Diesel	120/125/ 130	OM 651.924		05/14-12/17		DSN967	12	1.8
CLS 250 BlueTEC / d 4-matic	Diesel	150	OM 651.924		05/14-12/17		DSN967	12	1.8
CLS 250 CDI / BlueTEC / d	Diesel	150	OM 651.924		04/11-12/17		DSN967	12	1.8
COUPE (C124) (87-93)									
300 CE	Petrol	132/138	M 103.983		03/87-05/93		DSN3011	12	2.2

Starters & Alternators

Application Tables - Starters

									
MERCEDES-BENZ <i>continued</i>									
COUPE (C124) (87-93) <i>continued</i>									
300 CE-24	Petrol	162/170	M 104.980		09/89-12/92		DSN3011	12	2.2
320 CE	Petrol	162	M 104.992		10/92-05/93		DSN3011	12	2.2
E-CLASS (124) (92-96)									
E 36 AMG	Petrol	200	M 104.992 (AMG 3.6)		05/94-06/96		DSN3011	12	2.2
E 250 D	Diesel	83	OM 605.911		07/93-06/95		DSN3011	12	2.2
E 250 TD	Diesel	83	OM 605.911		06/93-06/96		DSN3011	12	2.2
E 280	Petrol	142/145	M 104.942		06/93-06/95		DSN3011	12	2.2
E 280 T	Petrol	142/145	M 104.942		06/93-06/96		DSN3011	12	2.2
E 300 4-matic	Petrol	132	M 103.985		06/93-06/95		DSN3011	12	2.2
E 300 D	Diesel	100	OM 606.910		07/93-06/95		DSN3011	12	2.2
E 300 T 4-matic	Petrol	132	M 103.985		06/93-06/96		DSN3011	12	2.2
E 300 TD	Diesel	100	OM 606.910		06/93-06/96		DSN3011	12	2.2
E 320	Petrol	162	M 104.992		06/93-06/95		DSN3011	12	2.2
E 320 T	Petrol	162	M 104.992		06/93-06/96		DSN3011	12	2.2
E-CLASS (210) (95-03)									
E 200 CDI	Diesel	75/85	OM 611.961		06/98-03/02		DSN3011	12	2.2
E 200 D	Diesel	65	OM 604.917		01/96-03/02		DSN3011	12	2.2
E 220 CDI	Diesel	92/100/105	OM 611.961		06/98-03/03		DSN3011	12	2.2
E 220 D	Diesel	55/70	OM 604.912		06/95-03/02		DSN3011	12	2.2
E 250 d	Diesel	83	OM 605.912		06/95-07/99		DSN3011	12	2.2
E 250 Turbo-D	Diesel	110	OM 605.962		06/97-07/99		DSN3011	12	2.2
E 290 Turbo-D	Diesel	95	OM 602.982		03/96-07/99		DSN3011	12	2.2
E 300 D	Diesel	100	OM 606.912		06/95-06/97		DSN3011	12	2.2
E 300 Turbo-D	Diesel	130	OM 606.962		12/96-07/99		DSN3011	12	2.2
E 320	Petrol	162	M 104.995		06/95-06/97		DSN3011	12	2.2
E-CLASS (211) (02-09)									
E 200 CDI	Diesel	100	OM 646.820;OM 646.821		04/06-07/09		DSN968	12	1.8
E 200 Kompressor	Petrol	120/135	M 271.941;M 271.956		11/02-07/09		DSN3010	12	1.1
E 200 NGT	Petrol/ Compressed Natural Gas (CNG)	120	M 271.941		03/04-12/08		DSN3010	12	1.1
E 220 CDI	Diesel	100/110	OM 646.961		03/02-12/08		DSN3011	12	2.2
E 220 CDI	Diesel	125	OM 646.821		04/06-07/09		DSN968	12	1.8
E 270 CDI	Diesel	130	OM 647.961	ATM	03/02-12/08		DSN968	12	1.8
E 270 CDI	Diesel	130	OM 647.961	MTM	03/03-07/09		DSN968	12	1.8
E 320 CDI	Diesel	150	OM 648.961		11/02-12/08		DSN3011	12	2.2
E-CLASS (212) (09-16)									
E 180	Petrol	115	M 274.910		08/13-12/15		DSN1205	12	1.7
E 200	Petrol	135	M 274.920		11/12-12/16		DSN1205	12	1.7
E 200 CDI / BlueTEC	Diesel	100	OM 651.925		01/09-12/16	- SS	DSN967	12	1.8
E 200 CGI	Petrol	135	M 271.820;M 271.860		08/09-12/16		DSN3010	12	1.1
E 200 NGT	Petrol/ Compressed Natural Gas (CNG)	115	M 274.920		07/13-12/15		DSN1205	12	1.7
E 200 NGT	Petrol/ Compressed Natural Gas (CNG)	120	M 271.958		03/11-12/15		DSN3010	12	1.1
E 220 CDI / BlueTEC	Diesel	120/125/130	OM 651.924		01/09-12/16	- SS	DSN967	12	1.8
E 250	Petrol	155	M 274.920		11/12-12/16		DSN1205	12	1.7
E 250 CDI / BlueTEC	Diesel	150	OM 651.924		01/09-12/16	- SS	DSN967	12	1.8
E 250 CDI / BlueTEC 4-matic	Diesel	150	OM 651.924		07/10-12/16	- SS	DSN967	12	1.8
E 250 CGI	Petrol	150	M 271.860		01/09-12/15		DSN3010	12	1.1
E-CLASS Coupe / Convertible (124) (93-98)									
E 36 AMG	Petrol	200	M 104.992 (AMG 3.6)		05/94-03/98		DSN3011	12	2.2
E 320	Petrol	162	M 104.992		06/93-03/98		DSN3011	12	2.2
E-CLASS Coupe / Convertible (207) (09-16)									
E 200	Petrol	135	M 274.920		03/13-12/16		DSN1205	12	1.7
E 200 CGI	Petrol	135	M 271.820;M 271.860		01/10-12/16		DSN3010	12	1.1



kW























kW

MERCEDÉS-BENZ continued										
E-CLASS Coupe / Convertible (207) (09-16) continued										
E 220 CDI / BlueTEC / d	Diesel	120/125/130	OM 651.911	MTM	01/10-12/16	- SS	DSN967	12	1.8	
E 250	Petrol	155	M 274.920		06/13-12/16		DSN1205	12	1.7	
E 250 CDI / BlueTEC / d	Diesel	150	OM 651.911	MTM	01/09-12/16	- SS	DSN967	12	1.8	
E 250 CGI	Petrol	150	M 271.860		01/09-12/16		DSN3010	12	1.1	
G-CLASS (W463) (89-)										
G 300 TD	Diesel	130	OM 606.964		08/96-07/00		DSN3011	12	2.2	
G 320 I-6	Petrol	155	M 104.996		09/94-12/97		DSN3011	12	2.2	
GLA (X156) (13-)										
GLA 45 AMG 4-matic	Petrol	265/280	M 133.980		05/14-		DSN1206	12	1.7	
GLA 180	Petrol	90	M 270.910	MTM	02/15-		DSN1206	12	1.7	
GLA 180 CDI / d	Diesel	80	OM 607.951		07/14-		DSN1206	12	1.7	
GLA 200	Petrol	115	M 270.910		12/13-		DSN1206	12	1.7	
GLA 200 CDI / d	Diesel	100	OM 651.930		12/13-		DSN1206	12	1.7	
GLA 200 CDI / d 4-matic	Diesel	100	OM 651.930		12/13-		DSN1206	12	1.7	
GLA 220 4-matic	Petrol	135	M 270.920		01/17-		DSN1206	12	1.7	
GLA 220 CDI / d	Diesel	120/125	OM 651.930		12/13-		DSN1206	12	1.7	
GLA 220 CDI / d 4-matic	Diesel	120/125	OM 651.930		12/13-		DSN1206	12	1.7	
GLA 220 d	Diesel	130	OM 651.930		07/15-		DSN1206	12	1.7	
GLA 250	Petrol	155	M 270.920		12/13-		DSN1206	12	1.7	
GLA 250 4-matic	Petrol	155	M 270.920		12/13-		DSN1206	12	1.7	
GLK (X204) (08-15)										
200	Petrol	135	M 274.920		08/13-06/15		DSN1205	12	1.7	
200 CDI	Diesel	100/105	OM 651.913;OM 651.916		07/10-06/15		DSN967	12	1.8	
220 CDI	Diesel	120/125	OM 651.916		12/08-06/15		DSN967	12	1.8	
220 CDI 4-matic	Diesel	120/125	OM 651.912		12/08-06/15		DSN967	12	1.8	
250	Petrol	155	M 274.920		08/13-06/15		DSN1205	12	1.7	
250 4-matic	Petrol	155	M 274.920		08/13-06/15		DSN1205	12	1.7	
250 CDI 4-matic	Diesel	150	OM 651.912		09/09-06/15		DSN967	12	1.8	
KOMBI (S124) (85-93)										
260 TE FGST.	Petrol	118/122	M 103.940		09/85-08/92		DSN3011	12	2.2	
280 TE	Petrol	145	M 104.942		10/92-06/93		DSN3011	12	2.2	
300 TE	Petrol	132/138	M 103.983		01/86-08/92		DSN3011	12	2.2	
300 TE 4-matic	Petrol	132/138	M 103.983;M 103.985		09/86-06/93		DSN3011	12	2.2	
300 TE-24	Petrol	162/170	M 104.980		09/89-08/92		DSN3011	12	2.2	
320 TE	Petrol	162	M 104.992		10/92-06/93		DSN3011	12	2.2	
Saloon (W124) (84-93)										
260 E	Petrol	118/122	M 103.940		09/85-08/92		DSN3011	12	2.2	
260 E 4-matic	Petrol	118/122	M 103.940;M 103.943		09/86-08/92		DSN3011	12	2.2	
280 E	Petrol	145	M 104.942		10/92-06/93		DSN3011	12	2.2	
300 E	Petrol	132/138	M 103.980;M 103.983		01/85-08/92		DSN3011	12	2.2	
300 E 4-matic	Petrol	132/138	M 103.983;M 103.985		09/86-06/93		DSN3011	12	2.2	
300 E-24	Petrol	162/170	M 104.980		09/88-08/92		DSN3011	12	2.2	
320 E	Petrol	162	M 104.992		10/92-06/93		DSN3011	12	2.2	
S-CLASS (W126) (79-91)										
260 SE	Petrol	118/122	M 103.941		09/85-06/91		DSN3011	12	2.2	
300 SE, SEL	Petrol	132/138	M 103.981		09/85-06/91		DSN3011	12	2.2	
S-CLASS (W140) (91-98)										
300 SE 2.8	Petrol	145	M 104.944		01/93-10/98		DSN3011	12	2.2	
300 SE, SEL/S320	Petrol	170	M 104.990;M 104.994		03/91-10/98		DSN3011	12	2.2	
S 280	Petrol	142	M 104.944		02/93-10/98		DSN3011	12	2.2	
S 300 Turbo-D	Diesel	130	OM 606.961		05/96-10/98		DSN3011	12	2.2	
S 350 Turbo-D	Diesel	110	OM 603.971		01/93-10/98		DSN3011	12	2.2	
SL (R107) (71-89)										
300 SL	Petrol	132/138	M 103.982		09/85-08/89		DSN3011	12	2.2	
SL (R129) (89-01)										
280	Petrol	142	M 104.943		08/93-10/01		DSN3011	12	2.2	
300	Petrol	140	M 103.984		03/89-08/93		DSN3011	12	2.2	
300-24	Petrol	170	M 104.981		03/89-07/93		DSN3011	12	2.2	
320	Petrol	170	M 104.991		09/93-10/01		DSN3011	12	2.2	
SLK (R171) (04-11)										
200 Kompressor	Petrol	120/135	M 271.944;M 271.954		03/04-02/11		DSN3010	12	1.1	
SLK (R172) (11-)										
200	Petrol	135	M 271.860;M 271.861		02/11-		DSN3010	12	1.1	
250	Petrol	150	M 271.860;M 271.861		02/11-		DSN3010	12	1.1	
250 CDI / d	Diesel	150	OM 651.980		01/12-		DSN967	12	1.8	
SPRINTER 2-t (901, 902) (95-06)										
2.1 208 CDI	Diesel	60	OM 611.987		04/00-05/06		DSN3011	12	2.2	

Starters & Alternators











Application Tables - Starters











									
MERCEDES-BENZ <i>continued</i>									
SPRINTER 2-t (901, 902) (95-06) <i>continued</i>									
2.1 211 CDI	Diesel	80	OM 611.981		04/00-05/06		DSN3011	12	2.2
2.1 213 CDI	Diesel	95	OM 611.981		04/00-05/06		DSN3011	12	2.2
2.3 208 D	Diesel	58/60	OM 601.943		01/95-04/00		DSN3011	12	2.2
2.9 210 D	Diesel	75	OM 602.980		01/97-04/00		DSN3011	12	2.2
2.9 212 D	Diesel	90	OM 602.980		02/95-04/00		DSN3011	12	2.2
SPRINTER 3,5-t (906) (06-)									
1.8 316	Petrol	115	M 271.951		09/08-		DSN3010	12	1.1
1.8 316 LGT	Petrol/ Liquified Petrol Gas (LPG)	115	M 271.951		09/08-		DSN3010	12	1.1
1.8 316 NGT	Petrol/ Compressed Natural Gas (CNG)	115	M 271.951		09/08-		DSN3010	12	1.1
2.1 309 CDI	Diesel	65	OM 646.984		06/06-12/09		DSN968	12	1.8
2.1 310 CDI	Diesel	70	OM 651.955;OM 651.956		03/09-		DSN967	12	1.8
2.1 311 CDI	Diesel	80/84	OM 646.985;OM 651.955		06/06-		DSN968	12	1.8
2.1 311 CDI 4x4	Diesel	80	OM 646.985		02/08-12/09		DSN968	12	1.8
2.1 313 CDI	Diesel	95	OM 646.986		06/06-		DSN968	12	1.8
2.1 313 CDI	Diesel	95	OM 651.940; OM 651.955;OM 651.956		06/06-		DSN967	12	1.8
2.1 313 CDI 4x4	Diesel	95	OM 651.955		06/06-		DSN967	12	1.8
2.1 314 CDI	Diesel	105	OM 651.955		05/16-		DSN968	12	1.8
2.1 314 CDI	Diesel	105	OM 651.955	MTM	05/16-	- SS	DSN967	12	1.8
2.1 314 CDI 4x4	Diesel	105	OM 651.955		05/16-		DSN968	12	1.8
2.1 315 CDI	Diesel	110	OM 646.986; OM 646.989;OM 646.990		06/06-12/09		DSN968	12	1.8
2.1 315 CDI 4x4	Diesel	110	OM 646.986; OM 646.989;OM 646.990		02/08-12/09		DSN968	12	1.8
2.1 316 CDI	Diesel	120	OM 651.955;OM 651.957		03/09-		DSN967	12	1.8
2.1 316 CDI 4x4	Diesel	120	OM 651.955;OM 651.957		03/09-		DSN967	12	1.8
SPRINTER 3,5-t (907, 910) (18-)									
2.1 311 CDI	Diesel	84	OM 651.950;OM 651.958		02/18-		DSN967	12	1.8
2.1 314 CDI	Diesel	105	OM 651.950;OM 651.958		02/18-		DSN967	12	1.8
2.1 314 CDI 4x4	Diesel	105	OM 651.958		01/19-		DSN967	12	1.8
2.1 316 CDI	Diesel	120	OM 651.958		02/18-		DSN967	12	1.8
2.1 316 CDI 4x4	Diesel	120	OM 651.958		01/19-		DSN967	12	1.8
SPRINTER 3-t (903) (95-06)									
2.1 308 CDI	Diesel	60	OM 611.987		04/00-05/06		DSN3011	12	2.2
2.1 311 CDI	Diesel	80	OM 611.981		04/00-05/06		DSN3011	12	2.2
2.1 311 CDI 4x4	Diesel	80	OM 611.981		08/02-05/06		DSN3011	12	2.2
2.1 313 CDI	Diesel	95	OM 611.981		04/00-05/06		DSN3011	12	2.2
2.1 313 CDI 4x4	Diesel	95	OM 611.981		08/02-05/06		DSN3011	12	2.2
2.3 308 D 2.3	Diesel	58/60	OM 601.943		02/95-04/00		DSN3011	12	2.2
2.9 310 D 2.9	Diesel	75	OM 602.980		02/95-04/00		DSN3011	12	2.2
2.9 310 D 2.9 4x4	Diesel	75	OM 602.980		06/97-04/00		DSN3011	12	2.2
2.9 310 D 4x4	Diesel	75	OM 602.980		05/97-08/02		DSN3011	12	2.2
2.9 312 D 2.9	Diesel	85/90	OM 602.980		02/95-09/01		DSN3011	12	2.2
2.9 312 D 2.9 4x4	Diesel	90	OM 602.980		05/97-08/02		DSN3011	12	2.2
SPRINTER 3-t (906) (06-)									
1.8 216	Petrol	115	M 271.951		09/08-		DSN3010	12	1.1
2.1 209 CDI	Diesel	65	OM 646.984		06/06-12/09		DSN968	12	1.8
2.1 210 CDI	Diesel	70	OM 651.955		03/09-		DSN967	12	1.8
2.1 211 CDI	Diesel	80/84	OM 646.985;OM 651.955		06/06-		DSN968	12	1.8
2.1 213 CDI	Diesel	95	OM 646.986		06/06-12/09		DSN968	12	1.8
2.1 213 CDI	Diesel	95	OM 651.955;OM 651.957		06/06-		DSN967	12	1.8
2.1 214 CDI	Diesel	105	OM 651.955		04/16-		DSN968	12	1.8
2.1 215 CDI	Diesel	110	OM 646.986; OM 646.989;OM 646.990		06/06-12/09		DSN968	12	1.8
2.1 216 CDI	Diesel	120	OM 651.955;OM 651.957		06/06-		DSN967	12	1.8
SPRINTER 4,6-t (906) (06-)									
2.1 411 CDI	Diesel	80	OM 646.985		06/09-12/18		DSN968	12	1.8
2.1 415 CDI	Diesel	110	OM 646.986; OM 646.989;OM 646.990		06/06-12/09		DSN968	12	1.8











									
MERCEDES-BENZ continued									
SPRINTER 4,6-t (906) (06-) continued									
2.1 416 CDI	Diesel	120	OM 651.955;OM 651.957		03/09-		DSN967	12	1.8
SPRINTER 4-t (904) (96-06)									
2.1 408 CDI	Diesel	60	OM 611.987		04/00-05/06		DSN3011	12	2.2
2.1 411 CDI	Diesel	80	OM 611.981		04/00-05/06		DSN3011	12	2.2
2.1 411 CDI 4x4	Diesel	80	OM 611.981		04/00-05/06		DSN3011	12	2.2
2.1 413 CDI	Diesel	95	OM 611.981		04/00-05/06		DSN3011	12	2.2
2.1 413 CDI 4x4	Diesel	95	OM 611.981		04/00-05/06		DSN3011	12	2.2
2.3 408 D	Diesel	58	OM 601.943		02/96-05/06		DSN3011	12	2.2
2.9 410 D	Diesel	75	OM 602.980		02/96-05/06		DSN3011	12	2.2
2.9 410 D 4x4	Diesel	75	OM 602.980		05/97-05/06		DSN3011	12	2.2
2.9 412 D	Diesel	85/90	OM 602.980		02/96-05/06		DSN3011	12	2.2
2.9 412 D 4x4	Diesel	85/90	OM 602.980		05/97-05/06		DSN3011	12	2.2
2.9 414 D 4x4	Diesel	90	OM 602.980		05/97-05/06		DSN3011	12	2.2
SPRINTER 5-t (906) (06-)									
1.8 516	Petrol	115	M 271.951		09/08-		DSN3010	12	1.1
1.8 516 NGT	Petrol/ Compressed Natural Gas (CNG)	115	M 271.951		09/08-		DSN3010	12	1.1
2.1 509 CDI	Diesel	65	OM 646.984		06/06-12/09		DSN968	12	1.8
2.1 510 CDI	Diesel	70	OM 651.955		03/09-		DSN967	12	1.8
2.1 511 CDI	Diesel	80	OM 646.985		06/06-12/09		DSN968	12	1.8
2.1 511 CDI 4x4	Diesel	80	OM 646.985		06/06-12/09		DSN968	12	1.8
2.1 513 CDI	Diesel	95	OM 646.986		06/06-		DSN968	12	1.8
2.1 513 CDI	Diesel	95	OM 651.955;OM 651.957		06/06-		DSN967	12	1.8
2.1 513 CDI 4x4	Diesel	95	OM 651.955;OM 651.957		06/06-		DSN967	12	1.8
2.1 515 CDI	Diesel	110	OM 646.986; OM 646.989;OM 646.990		06/06-12/09		DSN968	12	1.8
2.1 515 CDI 4x4	Diesel	110	OM 646.986; OM 646.989;OM 646.990		06/06-12/09		DSN968	12	1.8
2.1 516 CDI	Diesel	120	OM 651.955;OM 651.957		03/09-		DSN967	12	1.8
2.1 516 CDI 4x4	Diesel	120	OM 651.955;OM 651.957		06/06-		DSN967	12	1.8
VARIO (96-)									
2.9 512 D	Diesel	90	OM 602.984		09/96-12/10		DSN3011	12	2.2
2.9 612 D	Diesel	90	OM 602.984		09/96-12/10		DSN3011	12	2.2
2.9 812 D	Diesel	90	OM 602.984		09/96-12/10		DSN3011	12	2.2
2.9 O 812	Diesel	90	OM 602.984		09/96-12/10		DSN3011	12	2.2
V-CLASS (638/2) (96-03)									
V 200 CDI	Diesel	75	OM 611.980		03/99-07/03		DSN3011	12	2.2
V 220 CDI	Diesel	90	OM 611.980		03/99-07/03		DSN3011	12	2.2
V 230 TD	Diesel	72	OM 601.970		09/96-07/03		DSN3011	12	2.2
V-CLASS (W447) (14-)									
V 200 CDI / d	Diesel	100	OM 651.950		03/14-	- SS	DSN1445	12	1.8
V 200 CDI / d 4-matic	Diesel	100	OM 651.950		04/15-	- SS	DSN1445	12	1.8
V 220 CDI / d	Diesel	120	OM 651.950		03/14-	- SS	DSN1445	12	1.8
V 220 CDI / d 4-matic	Diesel	120	OM 651.950		03/15-	- SS	DSN1445	12	1.8
V 250 BlueTEC / d	Diesel	140	OM 651.950		03/14-	- SS	DSN1445	12	1.8
V 250 BlueTEC / d 4-matic	Diesel	140	OM 651.950		12/14-	- SS	DSN1445	12	1.8
VIANO (W639) (03-)									
2.0 CDI	Diesel	100	OM 651.940		07/10-		DSN967	12	1.8
2.0 CDI 4-matic	Diesel	100	OM 651.940		07/10-		DSN967	12	1.8
2.2 CDI	Diesel	110	OM 646.980		09/03-		DSN3011	12	2.2
2.2 CDI	Diesel	120	OM 651.940		07/10-		DSN967	12	1.8
2.2 CDI 4-matic	Diesel	120	OM 651.940		07/10-		DSN967	12	1.8
VITO (638) (96-03)									
2.1 108 CDI	Diesel	60	OM 611A (60 KW CDI)		03/99-07/03		DSN3011	12	2.2
2.1 110 CDI	Diesel	75	OM 611LA (75 KW CDI)		03/99-07/03		DSN3011	12	2.2
2.2 108 CDI	Diesel	60	OM 611A (60 KW CDI)		03/99-07/03		DSN3011	12	2.2
2.2 110 CDI	Diesel	75	OM 611LA (75 KW CDI)		03/99-07/03		DSN3011	12	2.2
2.2 112 CDI	Diesel	90	OM 611.980		03/99-07/03		DSN3011	12	2.2
2.3 108 D	Diesel	58	OM 601.942		02/96-07/03		DSN3011	12	2.2
2.3 110 D	Diesel	72	OM 601.970		03/97-07/03		DSN3011	12	2.2
2.3 110 TD	Diesel	72	OM 601.970		02/96-07/03		DSN3011	12	2.2
VITO (W447) (14-)									
2.1 114 CDI / BlueTEC	Diesel	100	OM 651.950		10/14-	- SS	DSN1445	12	1.8
2.1 114 CDI / BlueTEC 4x4	Diesel	100	OM 651.950		07/15-	- SS	DSN1445	12	1.8











Starters & Alternators

Application Tables - Starters

									
MERCEDES-BENZ continued									
VITO (W447) (14-) continued									
2.1 116 CDI / BlueTEC	Diesel	120	OM 651.950		10/14-	- SS	DSN1445	12	1.8
2.1 116 CDI / BlueTEC 4x4	Diesel	120	OM 651.950		07/15-	- SS	DSN1445	12	1.8
2.1 119 CDI / BlueTEC	Diesel	140	OM 651.950		10/14-	- SS	DSN1445	12	1.8
2.1 119 CDI / BlueTEC 4x4	Diesel	140	OM 651.950		12/14-	- SS	DSN1445	12	1.8
VITO / MIXTO (W639) (03-)									
2.1 109 CDI	Diesel	70	OM 646.980		08/06-		DSN3011	12	2.2
2.1 110 CDI	Diesel	70	OM 651.940		09/10-		DSN967	12	1.8
2.1 111 CDI	Diesel	85	OM 646.980		09/07-		DSN3011	12	2.2
2.1 113 CDI	Diesel	100	OM 651.940		09/10-		DSN967	12	1.8
2.1 113 CDI 4x4	Diesel	100	OM 651.940		09/10-		DSN967	12	1.8
2.1 115 CDI	Diesel	110	OM 646.980		09/03-		DSN3011	12	2.2
2.1 116 CDI	Diesel	120	OM 651.940		09/10-		DSN967	12	1.8
2.1 116 CDI 4x4	Diesel	120	OM 651.940		09/10-		DSN967	12	1.8
MG									
MG ZT (01-05)									
2.0 CDTi	Diesel	85/96	204D2		06/02-07/05		DSN601	12	2.0
160	Petrol	118	25 K4F	ATM	06/01-07/05		DSN603	12	2.0
160	Petrol	118	25 K4F	MTM	06/01-07/05		DSN941	12	1.4
180	Petrol	130	25 K4F	ATM	02/02-10/05		DSN603	12	2.0
180	Petrol	130	25 K4F	MTM	02/02-10/05		DSN941	12	1.4
190	Petrol	140	25 K4F	ATM	06/01-07/05		DSN603	12	2.0
190	Petrol	140	25 K4F	MTM	06/01-07/05		DSN941	12	1.4
NISSAN									
100 NX (90-94)									
1.6	Petrol	66	GA16DS	ATM	10/90-04/92		DSN951	12	1.2
ALMERA I (95-00)									
1.6	Petrol	73/75	GA16DE	ATM	07/95-04/00		DSN951	12	1.2
1.6 SLX	Petrol	66	GA16DE	ATM	09/95-04/00		DSN951	12	1.2
1.6 SR,SLX	Petrol	66	GA16DE	ATM	09/95-03/00		DSN951	12	1.2
ALMERA II (00-06)									
1.5	Petrol	66	QG15DE		03/00-03/01		DSN951	12	1.2
1.5	Petrol	72	QG15DE		10/02-11/06	+ Co	DSN951	12	1.2
1.5	Petrol	72	QG15DE	MTM	10/02-11/06	+ Co	DSN951	12	1.2
1.8	Petrol	85	QG18DE		01/00-03/01		DSN951	12	1.2
1.8	Petrol	85	QG18DE	ATM	10/02-11/06		DSN951	12	1.2
1.8	Petrol	85	QG18DE	MTM	10/02-11/06	+ Co	DSN951	12	1.2
ALMERA TINO (00-06)									
1.8	Petrol	85	QG18DE		08/00-01/03	+ Co	DSN951	12	1.2
1.8	Petrol	85	QG18DE	ATM	12/02-11/05		DSN951	12	1.2
1.8	Petrol	85	QG18DE	MTM	12/02-11/05	+ Co	DSN951	12	1.2
CABSTAR (F22) (82-93)									
2.5 TD	Diesel	55	TD25		01/89-12/92		DSN953	12	2.5
CABSTAR (F23) (92-00)									
2.5 D	Diesel	56	TD25		07/92-05/96		DSN953	12	2.5
JUKE (10-)									
1.6 DIG-T 190	Petrol	140	MR16DDT		06/10-12/13		DSN955	12	1
1.6 DIG-T 200 Nismo	Petrol	147	MR16DDT		03/13-12/13		DSN955	12	1
PATROL GR II (97-)									
3.0 DTi	Diesel	116/118	ZD30DDTi		05/00-12/06		DSN956	12	2.5
PICK UP (D21) (85-98)									
2.5 D	Diesel	55/59/61	TD25		09/87-02/98		DSN953	12	2.5
2.5 D 4WD	Diesel	59/61	TD25		08/87-02/98		DSN953	12	2.5
PICK UP (D22) (97-05)									
2.5 D	Diesel	61	TD25		02/98-11/01		DSN953	12	2.5
2.5 D 4WD	Diesel	61	TD25		02/98-11/01		DSN953	12	2.5
2.5 TD 4WD	Diesel	76	TD25Ti		05/98-11/01		DSN953	12	2.5
PRIMERA (P10) (90-98)									
1.6	Petrol	75	GA16DE		06/93-02/94	+ Co	DSN951	12	1.2
1.6 i	Petrol	66/75	GA16DE;GA16DS		07/90-12/97		DSN951	12	1.2
PRIMERA (P11) (96-02)									
1.6 16V	Petrol	66/73/78	GA16DE;QG16DE		09/96-12/01	+ Co	DSN951	12	1.2
1.8 16V	Petrol	84	QG18DE		08/99-12/01	+ Co	DSN951	12	1.2
2.0 16V	Petrol	103	SR20DE	ATM	05/01-07/02		DSN952	12	1.2
PRIMERA (P12) (02-)									
1.6	Petrol	78/80	QG16DE		01/02-06/10	+ Co	DSN951	12	1.2
1.6 Visia	Petrol	80	QG16DE		01/02-06/10	+ Co	DSN951	12	1.2
1.8	Petrol	85	QG18DE	ATM	03/02-06/10		DSN951	12	1.2











											
NISSAN continued											
PRIMERA (P12) (02-) continued											
1.8	Petrol	85	QG18DE		MTM	03/02-06/10	+ Co		DSN951	12	1.2
QASHQAI I (+2) (07-13)											
2.0	Petrol	104	MR20DE			02/07-12/13			DSN955	12	1
2.0 AWD	Petrol	104	MR20DE			02/07-12/13			DSN955	12	1
TERRANO I (87-96)											
2.7 TD 4WD	Diesel	73	TD27T			02/89-10/93			DSN953	12	2.5
TERRANO II (92-07)											
2.7 TD 4WD	Diesel	74	TD27T			05/96-01/02			DSN953	12	2.5
2.7 TDi 4WD	Diesel	92	TD27TI			03/99-12/06			DSN953	12	2.5
TIIDA (04-12)											
1.8	Petrol	93	MR18DE			09/07-12/12			DSN955	12	1
X-TRAIL (T30) (01-13)											
2.0	Petrol	103	QR20DE		ATM	07/01-03/07			DSN954	12	1.4
2.0 4x4	Petrol	103	QR20DE		ATM	07/01-03/07			DSN954	12	1.4
2.5 4x4	Petrol	121	QR25DE		ATM	09/02-03/07			DSN954	12	1.4
X-TRAIL (T31) (07-13)											
2.0 4x4	Petrol	104	MR20DE			06/07-11/13			DSN955	12	1
2.0 FWD	Petrol	103	MR20DE			03/07-11/13			DSN955	12	1
OPEL											
AGILA A (00-07)											
1.2 16V	Petrol	55	Z 12 XE			09/00-12/07			DSN3009	12	1.1
ANTARA (06-)											
2.0 CDTI	Diesel	125	B 20 DTH		MTM	01/16-			DSN1453	12	1.9
2.0 CDTI 4x4	Diesel	125	B 20 DTH		MTM	01/16-			DSN1453	12	1.9
ASTRA F (91-01)											
1.4 i	Petrol	44	C 14 NZ;X 14 NZ			09/91-01/99			DSN3009	12	1.1
1.4 i 16V	Petrol	66	X 14 XE			01/96-03/01			DSN3009	12	1.1
1.6	Petrol	55	16 LZ2;16 NZR			09/95-09/98			DSN3009	12	1.1
1.6 i	Petrol	52/55/74	C 16 NZ;C 16 SE; X 16 SZR			09/91-03/01			DSN3009	12	1.1
1.6 i 16V	Petrol	74	X 16 XEL			08/94-09/98			DSN3009	12	1.1
1.6 Si	Petrol	74	C 16 SE			03/92-12/94			DSN3009	12	1.1
ASTRA F CLASSIC (98-05)											
1.4 i	Petrol	44	X 14 NZ			01/98-01/05			DSN3009	12	1.1
1.6 i	Petrol	55	X 16 SZR			01/98-01/05			DSN3009	12	1.1
1.6 i 16V	Petrol	74	X 16 XEL			01/98-01/05			DSN3009	12	1.1
ASTRA G (98-09)											
1.2	Petrol	48	X 12 XE			09/98-08/00			DSN3009	12	1.1
1.2 16V	Petrol	48/55	X 12 XE;Z 12 XE			02/98-01/05			DSN3009	12	1.1
1.4	Petrol	66	X 14 XE;Z 14 XE			09/98-04/05			DSN3009	12	1.1
1.4 16V	Petrol	66	X 14 XE;Z 14 XE			02/98-01/05			DSN3009	12	1.1
1.4 LPG	Petrol/ Liquified Petroleum Gas (LPG)	66	X 14 XE;Z 14 XE			02/98-01/05			DSN3009	12	1.1
1.6	Petrol	55/62/ 74/76	C 16 SEL;X 16 SZR; Z 16 SE;Z 16 XE; Z 16 XEP			02/98-04/05			DSN3009	12	1.1
1.6 16V	Petrol	74	C 16 SEL;X 16 XEL; Z 16 XE			02/98-10/05			DSN3009	12	1.1
1.6 CNG	Petrol/ Compressed Natural Gas (CNG)	71	Z 16 YNG			03/03-07/04			DSN3009	12	1.1
1.6 LPG	Petrol/ Liquified Petroleum Gas (LPG)	74	X 16 XEL;Z 16 XE			03/98-01/05			DSN3009	12	1.1
2.0 DI	Diesel	60	X 20 DTL;Y 20 DTL			02/98-04/05			DSN3017	12	2
2.0 DTI 16V	Diesel	74	Y 20 DTH			08/99-01/05			DSN3017	12	2
2.2 DTI	Diesel	86/92	Y 22 DTR			09/02-10/05			DSN3017	12	2
ASTRA J (09-)											
1.6	Petrol	85	A 16 XER;B 16 XER			12/09-	+ SS		DSN1008	12	1.7
CASCADA (13-19)											
2.0 CDTI	Diesel	125	B 20 DTH		MTM	07/15-04/18	+ SS		DSN1453	12	1.9
COMBO B (94-01)											
1.4	Petrol	44/60	C 14 NZ;C 14 SE; X 14 SZ			07/94-10/01			DSN3009	12	1.1











									
OPEL continued									
COMBO B (94-01) continued									
1.4 16V	Petrol	66	X 14 XE		08/99-10/01		DSN3009	12	1.1
COMBO C (01-)									
1.3 CDTI 16V	Diesel	51	Z 13 DT	MTM	08/05-		DSN3009	12	1.1
1.6	Petrol	64	Z 16 SE		10/01-		DSN3009	12	1.1
1.6 CNG	Petrol/ Compressed Natural Gas (CNG)	71	Z 16 YNG		04/05-01/11		DSN3009	12	1.1
1.6 CNG 16V	Petrol/ Compressed Natural Gas (CNG)	71	Z 16 YNG		04/05-		DSN3009	12	1.1
COMBO E (18-)									
1.2	Petrol	33	C 12 NZ;X 12 SZ		07/94-10/01		DSN3009	12	1.1
CORSA A (82-93)									
1.2	Petrol	33/37/ 40/44	12 NV;12 S;12 ST; C 12 NZ		09/82-07/94		DSN3009	12	1.1
1.2 i	Petrol	33	C 12 NZ		09/89-03/93		DSN3009	12	1.1
1.2 N	Petrol	38	12 NV		01/90-03/93		DSN3009	12	1.1
1.2 S	Petrol	40/43	12 ST		09/82-03/93		DSN3009	12	1.1
1.3	Petrol	44/51	13 NB;13 SB;C 13 N		09/85-10/89		DSN3009	12	1.1
1.3 i	Petrol	44	C 13 N		09/86-09/90		DSN3009	12	1.1
1.3 S	Petrol	51	13 SB		09/82-10/89		DSN3009	12	1.1
1.4 i	Petrol	40/44	C 14 NZ		01/85-03/93		DSN3009	12	1.1
1.4 S	Petrol	53	14 NV		09/89-03/93		DSN3009	12	1.1
1.4 Si	Petrol	60	C 14 SE		09/91-03/93		DSN3009	12	1.1
1.6 GSI	Petrol	55/74	C 16 NZ;E 16 SE		05/88-09/92		DSN3009	12	1.1
1.6 GSI Cat	Petrol	74	C 16 SE		02/92-03/93		DSN3009	12	1.1
CORSA B (93-02)									
1.2	Petrol	33	C 12 NZ		08/94-12/01		DSN3009	12	1.1
1.2 i	Petrol	33	12 NZ;C 12 NZ; X 12 SZ		03/93-09/00		DSN3009	12	1.1
1.2 i 16V	Petrol	48	X 12 XE		03/98-09/00		DSN3009	12	1.1
1.4	Petrol	54	C 14 SE		04/93-08/94		DSN3009	12	1.1
1.4 i	Petrol	40/44	C 14 NZ;X 14 SZ		03/93-09/00		DSN3009	12	1.1
1.4 i 16V	Petrol	63/66	C 14 SEL;X 14 XE		09/94-12/02		DSN3009	12	1.1
1.4 Si	Petrol	60	C 14 SE		03/93-09/00		DSN3009	12	1.1
1.6 GSI 16V	Petrol	80	C 16 XE		03/93-09/00		DSN3009	12	1.1
1.6 i 16V	Petrol	74/78	C 16 SEL;X 16 XE		09/94-09/00		DSN3009	12	1.1
CORSA C (00-09)									
1.2	Petrol	55	Z 12 XE		09/00-12/09		DSN3009	12	1.1
1.2 16V	Petrol	55	Z 12 XE		09/00-12/09		DSN3009	12	1.1
1.4	Petrol	66	Z 14 XE		09/00-12/09		DSN3009	12	1.1
FRONTERA B (98-04)									
2.2 DTI	Diesel	85/88	X 22 DTH;Y 22 DTH		09/98-07/04		DSN3017	12	2
3.2 i	Petrol	151	6VD1 (DOHC);Y 32 NE		10/98-07/04		DSN1488	12	1.4
INSIGNIA (A) (08-17)									
2.0 CDTI	Diesel	125	B 20 DTH	MTM	11/14-03/17		DSN1453	12	1.9
2.0 CDTI 4x4	Diesel	125	B 20 DTH	MTM	11/14-03/17		DSN1453	12	1.9
INSIGNIA (B) (17-)									
2.0 CDTI	Diesel	125	B 20 DTH;D 20 DTH	MTM	03/17-	+ SS	DSN1453	12	1.9
2.0 CDTI	Diesel	125	D 20 DTH	MTM	06/17-		DSN1453	12	1.9
2.0 CDTI 4x4	Diesel	125	D 20 DTH	MTM	06/17-		DSN1453	12	1.9
2.0 CDTI 4x4	Diesel	125/154	D 20 DTH;D 20 DTR	MTM	03/17-	+ SS	DSN1453	12	1.9
KADETT E (84-94)									
1.2	Petrol	40	12 SC		09/84-07/86		DSN3009	12	1.1
1.3	Petrol	50	13 S		01/85-12/87		DSN3009	12	1.1
1.3 i Cat	Petrol	44	C 13 N		09/85-08/91		DSN3009	12	1.1
1.3 N	Petrol	44	13 N;13 NB		09/84-08/91		DSN3009	12	1.1
1.3 S	Petrol	55	13 S		09/84-02/93		DSN3009	12	1.1
1.4 i	Petrol	44	C 14 NZ		01/90-07/94		DSN3009	12	1.1
1.4 S	Petrol	55/60	14 NV;C 14 SE		07/89-02/93		DSN3009	12	1.1
1.6	Petrol	60	16 SV		09/86-12/91		DSN3009	12	1.1
1.6 i	Petrol	55/60	16 SV;C 16 NZ; E 16 NZ		09/86-07/94		DSN3009	12	1.1









									
OPEL continued									
KADETT E (84-94) continued									
1.6 i Cat	Petrol	55	C 16 LZ;C 16 NZ		09/86-02/93		DSN3009	12	1.1
1.6 S	Petrol	60/66	16 SH;16 SV		09/84-08/91		DSN3009	12	1.1
MERIVA A (03-10)									
1.6	Petrol	64/77	Z 16 SE;Z 16 XEP		05/03-05/10		DSN3009	12	1.1
1.6 16V	Petrol	74	Z 16 XE		05/03-01/06		DSN3009	12	1.1
MOKKA (12-)									
1.6	Petrol	85	A 16 XER;B 16 XER; D 16 XER		06/12-	+ SS	DSN1008	12	1.7
MONTEREY A (91-98)									
3.2	Petrol	130	6VD1 (SOHC)		08/91-03/94		DSN1488	12	1.4
MONTEREY B (98-99)									
3.5 V6 24V	Petrol	158	6 VE1		07/98-08/99		DSN1488	12	1.4
OMEGA B (94-03)									
2.0 DTI 16V	Diesel	74	X 20 DTH		09/97-09/00		DSN3017	12	2
2.2 DTI 16V	Diesel	81/88	Y 22 DTH		09/00-07/03		DSN3017	12	2
SIGNUM (03-08)									
2.0 DTI	Diesel	74	Y 20 DTH		05/03-04/04		DSN3017	12	2
2.2 DTI	Diesel	92	Y 22 DTR		05/03-04/04		DSN3017	12	2
SINTRA (96-99)									
2.2 DTI	Diesel	85	X 22 DTH		07/97-04/99		DSN3017	12	2
TIGRA (94-00)									
1.4 16V	Petrol	63/66	X 14 XE		07/94-12/00		DSN3009	12	1.1
1.6 16V	Petrol	74/78	C 16 SEL;X 16 XE		07/94-08/98		DSN3009	12	1.1
VECTRA A (88-95)									
1.4 S	Petrol	55	14 NV		04/88-06/92		DSN3009	12	1.1
1.6	Petrol	60	16 SV		09/88-05/93		DSN3009	12	1.1
1.6 i	Petrol	52/55	C 16 NZ;C 16 NZ2; E 16 NZ;X 16 SZ		09/88-11/95		DSN3009	12	1.1
1.6 i Cat	Petrol	55	C 16 NZ;C 16 NZ2		09/88-11/95		DSN3009	12	1.1
1.6 S	Petrol	60	16 SV		09/88-05/93		DSN3009	12	1.1
VECTRA B (95-03)									
1.6 i	Petrol	55	X 16 SZR		10/95-07/03		DSN3009	12	1.1
1.6 i 16V	Petrol	74	X 16 XEL;Y 16 XE; Z 16 XE		10/95-07/02		DSN3009	12	1.1
2.0 DI 16V	Diesel	60	X 20 DTL		11/96-04/02		DSN3017	12	2
2.0 DTI 16V	Diesel	74	X 20 DTH;Y 20 DTH		06/97-07/03		DSN3017	12	2
2.2 DTI 16V	Diesel	88/92	Y 22 DTR		09/00-07/03		DSN3017	12	2
VECTRA C (02-08)									
1.6	Petrol	74	Z 16 XE		08/05-08/08		DSN3009	12	1.1
1.6 16V	Petrol	74	Z 16 XE		07/04-10/05		DSN3009	12	1.1
2.0 DTI	Diesel	74	Y 20 DTH		10/03-08/05		DSN3017	12	2
2.0 DTI 16V	Diesel	74	Y 20 DTH		04/02-08/06		DSN3017	12	2
2.2 DTI	Diesel	92	Y 22 DTR		10/03-12/05		DSN3017	12	2
2.2 DTI 16V	Diesel	86/92	Y 22 DTR		04/02-06/08		DSN3017	12	2
ZAFIRA A (99-05)									
1.6 16V	Petrol	74	X 16 XEL;Z 16 XE		04/99-06/05		DSN3009	12	1.1
1.6 CNG	Petrol/ Compressed Natural Gas (CNG)	71	Z 16 YNG		09/01-06/05		DSN3009	12	1.1
1.6 LPG	Petrol/ Liquefied Petroleum Gas (LPG)	74	X 16 XEL;Z 16 XE		04/99-06/05		DSN3009	12	1.1
2.0 DI 16V	Diesel	60	X 20 DTL;Y 20 DTL		07/99-06/05		DSN3017	12	2
2.0 DTI 16V	Diesel	74	Y 20 DTH		09/00-06/05		DSN3017	12	2
2.2 DTI 16V	Diesel	86/92	Y 22 DTR		01/02-06/05		DSN3017	12	2
ZAFIRA B (05-14)									
1.6 CNG	Petrol/ Compressed Natural Gas (CNG)	69	Z 16 YNG		07/05-04/15		DSN3009	12	1.1











Starters & Alternators











Application Tables - Starters











									
OPEL continued									
ZAFIRA Tourer C (11-)									
2.0 CDTI	Diesel	125	B 20 DTH;D 20 DTH	MTM	01/15-	+ SS	DSN1453	12	1.9
PEUGEOT									
108 (14-)									
1.2	Petrol	60	HMT (EB2D); HMZ (EB2); HMZ (EB2F)		05/14-	- SS	DSN1368	12	1
206 (98-)									
1.9 D	Diesel	51	WJY (DW8B); WJZ (DW8)	5MTM	09/98-05/07		DSN3004	12	1.4
2.0 16V	Petrol	100	RFN (EW10J4)		06/99-12/07	- SS	DSN3004	12	1.4
2.0 HDi 90	Diesel	66	RHY (DW10TD)		12/99-09/09		DSN3004	12	1.4
2.0 RC	Petrol	130	RFK (EW10J4S)		07/03-12/07	- SS	DSN3004	12	1.4
2.0 S16	Petrol	100	RFR (EW10J4)		04/99-10/00	- SS	DSN3004	12	1.4
206 CC (00-08)									
2.0 16V	Petrol	100	RFN (EW10J4)		09/00-12/07	- SS	DSN3004	12	1.4
208 I (12-)									
1.0	Petrol	50	ZMZ (EB0)	MTM	03/12-		DSN1368	12	1
1.2	Petrol	60	HMZ (EB2); HMZ (EB2F)	MTM	03/12-	- SS	DSN1368	12	1
1.2 GPL	Petrol/ Liquified Petroleum Gas (LPG)	60	HMZ (EB2F)		06/15-		DSN1368	12	1
1.2 VTi / PureTech 68	Petrol	50	HMM (EB2FAD); HMP (EB2FB)	MTM	08/16-	- SS	DSN1368	12	1
301 (12-)									
1.2 VTi 72	Petrol	53	HMY (EB2M)	MTM	11/12-	- SS	DSN1368	12	1
1.2 VTi 82	Petrol	60	HMZ (EB2F)	MTM	12/14-	- SS	DSN1368	12	1
306 (93-02)									
1.9 D	Diesel	51	WJY (DW8B); WJZ (DW8)	5MTM	09/98-08/02		DSN3004	12	1.4
2.0 HDi 90	Diesel	66	RHY (DW10TD)		08/98-12/02		DSN3004	12	1.4
307 (00-12)									
2.0 16V	Petrol	100/103/ 130	RFJ (EW10A); RFK (EW10J4S); RFN (EW10J4)		10/03-04/09	- SS	DSN3004	12	1.4
2.0 HDi 110	Diesel	79	RHS (DW10ATED)		08/00-12/09		DSN3004	12	1.4
2.0 HDi 140	Diesel	103	RHR (DW10BTED4)		10/03-04/08		DSN3004	12	1.4
2.0 HDi 90	Diesel	66	RHY (DW10TD)		08/00-04/08		DSN3004	12	1.4
406 (95-04)									
1.8 16V	Petrol	85	6FZ (EW7J4)		10/00-10/04	- SS	DSN3004	12	1.4
2.0 16V	Petrol	100	RFN (EW10J4); RFR (EW10J4)		01/99-10/04	- SS	DSN3004	12	1.4
2.0 16V HPi	Petrol	103	RLZ (EW10D)		05/01-10/04	- SS	DSN3004	12	1.4
2.2	Petrol	116	3FZ (EW12J4)		07/00-10/04	- SS	DSN3004	12	1.4
406 Coupe (97-04)									
2.0 16V	Petrol	100	RFN (EW10J4); RFR (EW10J4); RFV (XU10J4R)		01/99-12/04	- SS	DSN3004	12	1.4
2.2	Petrol	116	3FZ (EW12J4)		03/02-12/04	- SS	DSN3004	12	1.4
407 (04-11)									
1.8	Petrol	85	6FZ (EW7J4)		03/04-07/05		DSN3004	12	1.4
1.8 16V	Petrol	92	6FY (EW7A)		08/05-12/10		DSN3004	12	1.4
2.0	Petrol	100	RFN (EW10J4)		03/04-07/05		DSN3004	12	1.4
2.0	Petrol	100	RFN (EW10J4)		05/04-07/05	- SS	DSN3004	12	1.4
2.0 16V	Petrol	103	RFJ (EW10A)		08/05-12/10	- SS	DSN3004	12	1.4
2.0 16V	Petrol	103/105	RFJ (EW10A)		09/05-12/10		DSN3004	12	1.4
2.0 Bioflex	Flexfuel	103	RFJ (EW10A)		09/07-02/11	- SS	DSN3004	12	1.4
2.2	Petrol	116	3FZ (EW12J4)		03/04-10/06	- SS	DSN3004	12	1.4
2.2 16V	Petrol	120	3FY (EW12J4)		08/05-12/10	- SS	DSN3004	12	1.4
2.7 HDi 204	Diesel	150	DT17TED4		10/05-12/10		DSN942	12	2.2
407 Coupe (05-)									
2.2 16V	Petrol	120	3FY (EW12J4)		10/05-	- SS	DSN3004	12	1.4
2.7 HDi 204	Diesel	150	DT17TED4		10/05-		DSN942	12	2.2
3.0 HDi 240	Diesel	177	DT20C		06/09-		DSN942	12	2.2
607 (00-11)									
2.0	Petrol	100	RFN (EW10J4)		02/00-08/05	- SS	DSN3004	12	1.4
2.2 16V	Petrol	116/120	3FY (EW12J4); 3FZ (EW12J4)		02/00-06/10	- SS	DSN3004	12	1.4











									
PEUGEOT continued									
607 (00-11) continued									
2.7 HDi 204	Diesel	150	DT17TED4		12/04-07/11		DSN942	12	2.2
806 (94-02)									
2.0 16V	Petrol	100	RFN (EW10J4)		09/00-08/02	- SS	DSN3004	12	1.4
807 (02-)									
2.0	Petrol	100	RFN (EW10J4)		06/02-	- SS	DSN3004	12	1.4
2.0 16V	Petrol	103	RFJ (EW10A)		09/05-	- SS	DSN3004	12	1.4
2.2	Petrol	116	3FZ (EW12J4)		06/02-	- SS	DSN3004	12	1.4
2008 I (13-)									
1.2 VTi 82	Petrol	60	HMZ (EB2); HMZ (EB2F)	MTM	03/13-12/18	- SS	DSN1368	12	1
BOXER (02-)									
2.8 HDi 128	Diesel	94	8140.43S (F28DTCR)		04/02-		DSN3014	12	2.5
2.8 HDi 128 4x4	Diesel	94	8140.43S (F28DTCR)		04/02-		DSN3014	12	2.5
2.8 HDi 146	Diesel	107	8140.43N		04/04-		DSN3014	12	2.5
BOXER (06-)									
2.2 HDi 100	Diesel	74	4HV (P22DTE)		04/06-		DSN3012	12	2
2.2 HDi 110	Diesel	81	4HG (P22DTE)		03/11-		DSN3012	12	2
2.2 HDi 120	Diesel	88	4HU (P22DTE)		04/06-		DSN3012	12	2
2.2 HDi 130	Diesel	96	4HH (P22DTE)		03/11-	- SS	DSN3012	12	2
2.2 HDi 150	Diesel	110	4HJ (P22DTE)		03/11-	- SS	DSN3012	12	2
3.0 HDi 145	Diesel	107	F1CE3481N (F30DTE)		04/10-		DSN3013	12	2.5
3.0 HDi 160	Diesel	116	F1CE0481D (F30DT)		04/06-		DSN3013	12	2.5
3.0 HDi 175	Diesel	130	F1CE3481E (F30DTE)		03/11-		DSN3013	12	2.5
EXPERT (96-06)									
1.9 D	Diesel	51	WJY (DW8B); WJZ (DW8)	5MTM	06/98-12/06		DSN3004	12	1.4
1.9 D 70	Diesel	51	WJY (DW8B); WJZ (DW8)	5MTM	12/98-12/06		DSN3004	12	1.4
2.0	Petrol	100	RFN (EW10J4)		07/00-12/06	- SS	DSN3004	12	1.4
2.0 HDi 110	Diesel	80	RHW (DW10ATED4); RHZ (DW10ATED); RHZ (DW10BTED); RHZ (DW10BTED+); RHZ (DW10CTED)		07/00-12/06		DSN3004	12	1.4
2.0 HDi 95	Diesel	69	RHX (DW10BTED)		07/00-12/06		DSN3004	12	1.4
EXPERT (07-)									
2.0 16V	Petrol	103	RFH (EW10A); RFJ (EW10A)		01/07-	- SS	DSN3004	12	1.4
PARTNER / RANCH (96-15)									
1.9 D	Diesel	51	WJY (DW8B); WJZ (DW8)	5MTM	06/96-12/15		DSN3004	12	1.4
1.9 D 4x4	Diesel	51	WJY (DW8B)	MTM	04/04-07/11		DSN3004	12	1.4
2.0 HDi 90	Diesel	66	RHY (DW10TD)		02/00-07/08		DSN3004	12	1.4
2.0 HDi 90 4x4	Diesel	66	RHY (DW10TD)		04/04-08/05		DSN3004	12	1.4
PORSCHE									
911 (991) (11-)									
3.8 GT3	Petrol	350	MA1.75		08/13-		DSN971	12	1.3
4.0 GT3 RS / R	Petrol	368	MA1.76;MDG.GA		04/15-		DSN971	12	1.3
911 (997) (04-12)									
3.6 Carrera	Petrol	254	MA1.02		06/08-12/11		DSN970	12	1.8
3.6 Carrera 4	Petrol	254	MA1.02		06/08-12/12		DSN970	12	1.8
3.8 Carrera 4 GTS	Petrol	300	MA1.01		06/09-12/12		DSN970	12	1.8
3.8 Carrera 4S	Petrol	283	MA1.01		06/08-12/12		DSN970	12	1.8
3.8 Carrera GTS	Petrol	300	MA1.01		06/09-12/11		DSN970	12	1.8
3.8 Carrera S	Petrol	283	MA1.01		06/08-12/11		DSN970	12	1.8
3.8 Turbo	Petrol	368	MA1.70		09/09-12/12		DSN970	12	1.8
3.8 Turbo S	Petrol	390	MA1.70		02/10-12/12		DSN970	12	1.8
BOXSTER (981) (12-)									
3.8	Petrol	276	MDB.XA		01/15-		DSN971	12	1.3
BOXSTER (987) (04-12)									
2.9	Petrol	188	MA1.20		06/09-03/12		DSN970	12	1.8
3.4	Petrol	235	MA1.21		02/10-12/11		DSN970	12	1.8
3.4 S	Petrol	228	MA1.21		06/09-12/11		DSN970	12	1.8
CAYENNE (92A) (10-)									
3.0 Diesel	Diesel	155/176/ 180	MCN.RB;MCR.C; MCR.CA;MCR.CB; MCV.VC		06/10-	+ SS	DSN965	12	2.0
3.0 Diesel	Diesel	193	MCV.VA		10/14-		DSN965	12	2.0
CAYMAN (981) (13-)									
3.8 GT4	Petrol	283	MDB.XA		01/15-		DSN971	12	1.3





									
PORSCHE continued									
CAYMAN (987) (05-12)									
2.9	Petrol	195	MA1.20		02/09-12/12		DSN970	12	1.8
3.4 R	Petrol	243	MA1.21		11/10-12/12		DSN970	12	1.8
3.4 S	Petrol	235	MA1.21		02/09-06/13		DSN970	12	1.8
MACAN (95B) (14-)									
2.0	Petrol	174/185	DLHB;MCN.CC; MCY.NB;MCY.PA		07/14-	+ SS	DSN1201	12	1.5
3.0 S Diesel	Diesel	155/184/ 190	MCT.BA;MCT.BB; MCT.BC		02/14-09/18	+ SS	DSN1203	12	1.9
PANAMERA (970) (09-16)									
3.0 D	Diesel	155/184	MCR.CB;MCR.CC		08/11-07/13		DSN965	12	2.0
PUCH									
G-MODELL (W463) (89-00)									
G 300 TD	Diesel	130	OM 606.964		01/96-11/00		DSN3011	12	2.2
G 320 I-6	Petrol	155	M 104.996		02/94-12/97		DSN3011	12	2.2
RENAULT									
CLIO III (05-14)									
2.0 16V	Petrol	102	M4R 700;M4R 701		09/06-12/14		DSN955	12	1
FLUENCE (10-)									
2.0 16V	Petrol	103	M4R 714;M4R 751		02/10-		DSN955	12	1
Grand SCÉNIC III (09-)									
2.0 16V	Petrol	103	M4R 711		02/09-		DSN955	12	1
LAGUNA III (07-15)									
2.0 16V	Petrol	103	M4R 704		10/07-12/15		DSN955	12	1
2.0 16V Hi-Flex	Flexfuel	103	M4R 704;M4R 726		10/07-12/15		DSN955	12	1
MEGANE CC (10-)									
2.0 CVT	Petrol	103	M4R 711;M4R 713		06/10-		DSN955	12	1
MEGANE III (08-)									
2.0 CVT	Petrol	103	M4R 711;M4R 713		02/09-		DSN955	12	1
SCÉNIC III (09-)									
2.0 16V	Petrol	103	M4R 710;M4R 711; M4R 713		02/09-		DSN955	12	1
ROLLS-ROYCE									
DAWN (15-)									
V12	Petrol	420/442	N74 B66 A		02/16-		DSN1476	12	1.6
GHOST I (08-20)									
6.6 V12	Petrol	420/442/ 450	N74 B66 A		12/09-03/20		DSN1476	12	1.6
WRAITH (13-)									
6.75 V12	Petrol	465	N74 B66 A		08/13-		DSN1476	12	1.6
ROVER									
75 (99-05)									
2.0 CDT	Diesel	85	204D2;M 47 R		02/99-05/05		DSN601	12	2.0
2.0 CDTi	Diesel	96	204D2		02/03-05/05		DSN601	12	2.0
2.0 V6	Petrol	110	20K4F/20K6F	ATM	02/99-05/05		DSN603	12	2.0
2.0 V6	Petrol	110	20K4F/20K6F	MTM	02/99-05/05		DSN941	12	1.4
2.5 V6	Petrol	130	25 K4F;KV 6	ATM	02/99-05/05		DSN603	12	2.0
2.5 V6	Petrol	130	25 K4F;KV 6	MTM	02/99-05/05		DSN941	12	1.4
SAAB									
9-3 (98-03)									
2.2 TiD	Diesel	85	D223L;X 22 DTH		02/98-11/00		DSN3017	12	2
9-3 (02-15)									
1.9 TTiD	Diesel	96/118/ 132	A 19 DTR;Z 19 DTR		12/07-02/15		DSN3018	12	2
9-5 (97-09)									
2.2 TiD	Diesel	88	D223L		03/02-12/09		DSN3017	12	2
SEAT									
ALHAMBRA (7V) (96-10)									
1.8 T 20V	Petrol	110	AWC	ATM	06/00-03/10	HI	DSN957	12	1.4
1.9 TDI	Diesel	85	AUY;BVK	ATM	06/00-03/10	HI	DSN958	12	2.4
1.9 TDI 4motion	Diesel	85	AUY;BVK	ATM	06/00-03/10	HI	DSN958	12	2.4
2.8 V6	Petrol	150	AYL	ATM	06/00-03/10	HI	DSN957	12	1.4
2.8 V6 4motion	Petrol	150	AYL	ATM	06/00-03/10	HI	DSN957	12	1.4
ALHAMBRA (710) (10-)									
1.4 TSI	Petrol	110	CAVA	MTM	06/10-	+ SS	DSN962	12	2.0
1.4 TSI	Petrol	110	CZDA;DJKA	ATM	05/15-	BO;+ SS	DSN1464	12	1.5
1.4 TSI	Petrol	110	CZDA;DJKA	MTM	05/15-	BO;+ SS	DSN1468	12	1.5
2.0 TDI	Diesel	85/100/ 103/110/ 125/130/ 135	CFFA;CFFB;CFFE; CFGB;CFGC;CUVA; CUVC;CUWA;DFLA; DFLD;DFMA;DLTA; DLTC;DLUB	MTM	06/10-	BO;VA;+ SS	DSN1461	12	2.0











										
SEAT continued										
ALHAMBRA (710) (10-) continued										
2.0 TDI	Diesel	85/100/103/110/125/130/135	CFFA;CFFB;CFGB;CFGC;CUVA;CUVC;CUWA;DFLA;DFMA;DLTA;DLUB	ATM	06/10-			BO;VA;+ SS	DSN1460	12 2.0
2.0 TDI 4Drive	Diesel	103/110/135	CFFB;CUVC;DFLA;DFMA	ATM	05/11-			BO;VA;+ SS	DSN1460	12 2.0
2.0 TDI 4Drive	Diesel	103/110/135	CFFB;CUVC;DFLA;DFMA	MTM	05/11-			BO;VA;+ SS	DSN1461	12 2.0
2.0 TSI	Petrol	162	DEDA	ATM	05/15-			BO;+ SS	DSN1464	12 1.5
ALTEA (XL) (5P) (04-)										
1.2 TSI	Petrol	77	CBZB	MTM	04/10-			+ SS	DSN964	12 2.0
1.2 TSI	Petrol	77	CBZB	MTM	04/10-			BO;+ SS	DSN1467	12 2.0
1.4 16V	Petrol	63	BXW		05/06-				DSN3006	12 1
1.6 TDI	Diesel	77	CAYC	MTM	10/09-			BO;VA;- SS	DSN963	12 2.0
1.6 TDI	Diesel	77	CAYC	ATM	10/09-			BO;VA;+ SS	DSN1463	12 2.0
1.6 TDI	Diesel	77	CAYC	MTM	10/09-			BO;VA;+ SS	DSN1462	12 2.0
1.9 TDI	Diesel	66	BXF	MTM	08/09-				DSN3007	12 1.7
1.9 TDI	Diesel	77	BJB;BKC;BLS;BXE		04/04-				DSN3007	12 1.7
1.9 TDI 4x4	Diesel	77	BLS		06/09-12/10				DSN3007	12 1.7
2.0 FSI	Petrol	110	BLR;BLY;BVY;BVZ	MTM	05/04-03/09				DSN3005	12 1.1
2.0 FSI	Petrol	110	BVY;BVZ		10/06-03/09				DSN3005	12 1.1
2.0 TDI	Diesel	100	AZV		03/04-05/09				DSN3008	12 1.7
2.0 TDI	Diesel	103	BKD	ATM	09/10-			BO;VA	DSN3008	12 1.7
2.0 TDI	Diesel	103	BKD	ATM	09/10-			BO;VA;- SS	DSN3008	12 1.7
2.0 TDI	Diesel	103	CFHC	MTM	09/10-			BO;VA;- SS	DSN963	12 2.0
2.0 TDI	Diesel	103/125	CEGA;CFHC	ATM	03/06-			BO;VA;+ SS	DSN1460	12 2.0
2.0 TDI	Diesel	103/125	CEGA;CFHC	MTM	03/06-			BO;VA;+ SS	DSN1461	12 2.0
2.0 TDI 4x4	Diesel	103/125	CEGA;CFHC	ATM	09/10-			BO;VA;+ SS	DSN1460	12 2.0
2.0 TDI 4x4	Diesel	103/125	CEGA;CFHC;CFJA	MTM	09/10-			BO;VA;+ SS	DSN1461	12 2.0
2.0 TDI 4x4	Diesel	125	CFJA	MTM	09/10-05/09			BO;VA;- SS	DSN963	12 2.0
2.0 TDI 8V	Diesel	103	BMM		11/05-				DSN3008	12 1.7
2.0 TDI 8V 4x4	Diesel	103	BMM		06/07-				DSN3008	12 1.7
2.0 TFSI	Petrol	147	BWA		04/06-05/09				DSN3005	12 1.1
2.0 TFSI	Petrol	147	BWA	MTM	10/06-05/09				DSN3005	12 1.1
2.0 TFSI 4x4	Petrol	147	BWA	MTM	06/07-05/09				DSN3005	12 1.1
ARONA (KJ7) (17-)										
1.0 TGi	Petrol/Compressed Natural Gas (CNG)	66	DBYA		11/18-			+ SS	DSN1468	12 1.5
1.0 TSI	Petrol	70	CHZL;DKLA	MTM	07/17-			BO;+ SS	DSN1468	12 1.5
1.0 TSI	Petrol	70/85	CHZJ;CHZL;DKJA;DKLA;DKRF	ATM	07/17-			BO;+ SS	DSN1465	12 1.5
1.0 TSI	Petrol	85	CHZJ;DKJA;DKRF	MTM	07/17-			+ SS	DSN1466	12 1.5
1.5 TSI	Petrol	110	DADA;DPCA	MTM	07/17-			BO;+ SS	DSN1468	12 1.5
1.6 TDI	Diesel	70/85	DGTA;DGTD	MTM	07/17-			BO;VA;+ SS	DSN1462	12 2.0
ATECA (KH7) (16-)										
1.0 TSI	Petrol	85	CHZJ;DKRF	MTM	05/16-			+ SS	DSN1466	12 1.5
1.0 TSI	Petrol	85	CHZJ;DKRF	ATM	05/16-			BO;+ SS	DSN1465	12 1.5
1.4 TSI	Petrol	110	CZEA	MTM	06/16-			+ SS	DSN1466	12 1.5
1.4 TSI	Petrol	110	CZEA	ATM	06/16-			BO;+ SS	DSN1465	12 1.5
1.4 TSI 4Drive	Petrol	110	CZEA	ATM	06/16-			BO;+ SS	DSN1464	12 1.5
1.4 TSI 4Drive	Petrol	110	CZEA	MTM	06/16-			BO;+ SS	DSN1468	12 1.5
1.5 TSI	Petrol	110	DADA;DPCA		07/18-			MY: >2016;+ SS	DSN1462	12 2.0
1.6 TDI	Diesel	85	DDYA;DGTE	ATM	04/16-			BO;VA;+ SS	DSN1463	12 2.0
1.6 TDI	Diesel	85	DDYA;DGTE	MTM	04/16-			BO;VA;+ SS	DSN1462	12 2.0
2.0 TDI	Diesel	81/105/110	CRVA;CRVC;DFFA	ATM	04/16-			BO;VA;+ SS	DSN1460	12 2.0
2.0 TDI	Diesel	81/105/110	CRVA;CRVC;DFFA	MTM	04/16-			BO;VA;+ SS	DSN1461	12 2.0
2.0 TDI 4Drive	Diesel	110/140	DFFA;DFHA	ATM	04/16-			BO;VA;+ SS	DSN1460	12 2.0
2.0 TDI 4Drive	Diesel	110/140	DFFA;DFHA	MTM	04/16-			BO;VA;+ SS	DSN1461	12 2.0
2.0 TSI 4Drive	Petrol	140	CZPB;DKZA	ATM	05/17-			BO;-/+ SS	DSN1464	12 1.5
CORDOBA (6L) (02-09)										
1.2	Petrol	47	AZQ;BME	MTM	10/02-06/06				DSN3006	12 1
1.2 12V	Petrol	51	BXV	MTM	05/06-11/09				DSN3006	12 1
1.4 16V	Petrol	55/63	BKY;BXW		09/02-11/09				DSN3006	12 1











									
SEAT continued									
CORDOBA (6L) (02-09) continued									
1.4 16V	Petrol	74	BBZ	MTM	10/02-11/09		DSN3006	12	1
1.4 TDI	Diesel	55	AMF		10/02-12/05		DSN3007	12	1.7
1.4 TDI	Diesel	59	BMS;BNV	MTM	06/05-11/09		DSN3007	12	1.7
1.6	Petrol	74	BAH	MTM	04/03-11/09		DSN3006	12	1
1.6 16V	Petrol	77	BTS		11/06-11/09		DSN3006	12	1
1.9 TDI	Diesel	74	ATD;AXR;BMT	MTM	09/02-11/09		DSN3007	12	1.7
IBIZA III (6L) (02-09)									
1.2	Petrol	44/47	AZQ;BBM;BME	MTM	02/02-05/08		DSN3006	12	1
1.2 12V	Petrol	51	BXV	MTM	05/06-11/09		DSN3006	12	1
1.4 16V	Petrol	55/63	BKY;BXW		02/02-11/09		DSN3006	12	1
1.4 16V	Petrol	74	BBZ	MTM	02/02-11/09		DSN3006	12	1
1.4 TDI	Diesel	55	AMF		05/02-12/05		DSN3007	12	1.7
1.4 TDI	Diesel	59	BMS;BNV	MTM	06/05-11/09		DSN3007	12	1.7
1.6	Petrol	74	BAH	MTM	02/03-11/09		DSN3006	12	1
1.6 16V	Petrol	77	BTS	ATM	11/06-11/09		DSN3005	12	1.1
1.9 TDI	Diesel	74	ATD;AXR;BMT	MTM	02/02-11/09		DSN3007	12	1.7
IBIZA IV (6J, 6P) (08-17)									
1.0	Petrol	55	CHYB	ATM	05/15-06/17	BO;+ SS	DSN1465	12	1.5
1.0	Petrol	55	CHYB	MTM	05/15-06/17	BO;+ SS	DSN1468	12	1.5
1.0 TSI	Petrol	70/81	CHZB;CHZC	ATM	05/15-06/17	BO;+ SS	DSN1465	12	1.5
1.0 TSI	Petrol	70/81	CHZB;CHZC	MTM	05/15-06/17	BO;+ SS	DSN1468	12	1.5
1.2	Petrol	51	BZG	MTM	03/08-05/15		DSN3006	12	1
1.2 LPG	Petrol/ Liquified Petroleum Gas (LPG)	51	BZG	MTM	03/08-05/11		DSN3006	12	1
1.2 TDI	Diesel	55	CFWA	MTM	04/10-05/15	BO;VA;- SS	DSN963	12	2.0
1.2 TDI	Diesel	55	CFWA	MTM	04/10-05/15	BO;VA;+ SS	DSN1462	12	2.0
1.2 TSI	Petrol	63	CBZA		08/12-05/15	- SS	DSN3006	12	1
1.2 TSI	Petrol	77	CBZB	MTM	09/10-05/15	- SS	DSN3006	12	1
1.2 TSI 16V	Petrol	66/81	CJZC;CJZD	ATM	05/15-06/17	BO;+ SS	DSN1465	12	1.5
1.2 TSI 16V	Petrol	66/81	CJZC;CJZD	MTM	05/15-06/17	BO;+ SS	DSN1468	12	1.5
1.4	Petrol	63	BXW		03/08-05/15		DSN3006	12	1
1.4 LPG	Petrol/ Liquified Petroleum Gas (LPG)	63	BXW		03/08-05/11		DSN3006	12	1
1.4 TDI	Diesel	55/66/77	CUSA;CUSB;CUTA; CYZA	MTM	05/15-06/17	BO;VA;+ SS	DSN1462	12	2.0
1.4 TDI	Diesel	59	BMS	MTM	07/08-06/10		DSN3007	12	1.7
1.4 TSI	Petrol	110	CZEA	MTM	11/15-06/17	BO;+ SS	DSN1468	12	1.5
1.6	Petrol	77	BTS		05/08-05/15		DSN3006	12	1
1.6 LPG	Petrol/ Liquified Petroleum Gas (LPG)	60	CNKA	MTM	05/11-05/15	- SS	DSN3006	12	1
1.6 TDI	Diesel	66/77	CAYB;CAYC;CLNA	MTM	05/09-05/15	BO;VA;- SS	DSN963	12	2.0
1.6 TDI	Diesel	66/77	CAYB;CAYC;CLNA	MTM	05/09-05/15	BO;VA;+ SS	DSN1462	12	2.0
1.8 TSI Cupra	Petrol	141	DAJA	MTM	11/15-12/16	BO;+ SS	DSN1468	12	1.5
1.9 TDI	Diesel	66/77	BLS;BXJ		03/08-06/10		DSN3007	12	1.7
2.0 TDI	Diesel	105	CFHD	MTM	01/10-05/15	BO;VA;+ SS	DSN1461	12	2.0
IBIZA V (KJ1) (17-)									
1.0	Petrol	48/55	CHYB;CHYC;DFNB	ATM	01/17-	BO;+ SS	DSN1465	12	1.5
1.0	Petrol	48/55	CHYB;CHYC;DFNB	MTM	01/17-	BO;+ SS	DSN1468	12	1.5
1.0 MPI	Petrol	59	DFNA;DSGB		07/18-	+ SS	DSN1466	12	1.5
1.0 TGI	Petrol/ Compressed Natural Gas (CNG)	66	DBYA		11/17-	+ SS	DSN1468	12	1.5
1.0 TSI	Petrol	70	CHZL;DKLA	MTM	01/17-	BO;+ SS	DSN1468	12	1.5
1.0 TSI	Petrol	70/85	CHZJ;CHZL;DKJA; DKLA;DKRF	ATM	01/17-	BO;+ SS	DSN1465	12	1.5
1.0 TSI	Petrol	85	CHZJ;DKJA;DKRF	MTM	01/17-	+ SS	DSN1466	12	1.5
1.5 TSI	Petrol	110	DADA	MTM	07/17-	BO;+ SS	DSN1468	12	1.5











										
SEAT continued										
IBIZA V (KJ1) (17-) continued										
1.6 TDI	Diesel	59/70	DGTC;DGTD	MTM	09/17-	BO;VA;+ SS	DSN1462	12	2.0	
1.6 TDI	Diesel	85	DGTA		12/17-	+ SS	DSN1462	12	2.0	
LEON (1P) (05-12)										
1.2 TSI	Petrol	77	CBZB	MTM	02/10-12/12	+ SS	DSN964	12	2.0	
1.2 TSI	Petrol	77	CBZB	MTM	02/10-12/12	BO;+ SS	DSN1467	12	2.0	
1.4 16V	Petrol	63	BXW		06/06-12/12		DSN3006	12	1	
1.6	Petrol	75	BSE;BSF;CCSA	ATM	07/05-12/12		DSN3005	12	1.1	
1.6 MultiFuel	Flexfuel	75	BSE;CCSA;CMXA	ATM	07/05-08/13		DSN3005	12	1.1	
1.6 TDI	Diesel	77	CAYC	MTM	02/10-12/12	BO;VA;- SS	DSN963	12	2.0	
1.6 TDI	Diesel	77	CAYC	ATM	02/10-12/12	BO;VA;+ SS	DSN1463	12	2.0	
1.6 TDI	Diesel	77	CAYC	MTM	02/10-12/12	BO;VA;+ SS	DSN1462	12	2.0	
1.9 TDI	Diesel	66	BXF	MTM	06/07-12/10		DSN3007	12	1.7	
1.9 TDI	Diesel	77	BKC;BLS;BXE		07/05-12/10		DSN3007	12	1.7	
2.0 Cupra R	Petrol	195	CDLA	MTM	09/09-12/12		DSN3005	12	1.1	
2.0 FSI	Petrol	110	BLR;BLY;BVY;BVZ	MTM	07/05-05/10		DSN3005	12	1.1	
2.0 TDI	Diesel	100	AZV		07/05-05/10		DSN3008	12	1.7	
2.0 TDI	Diesel	103	BKD	ATM	05/10-12/12	BO;VA;- SS	DSN3008	12	1.7	
2.0 TDI	Diesel	103/125	CEGA;CFHC	ATM	05/10-12/12	BO;VA;+ SS	DSN1460	12	2.0	
2.0 TDI	Diesel	103/125	CEGA;CFHC;CFJA;CLCB	MTM	05/10-12/12	BO;VA;+ SS	DSN1461	12	2.0	
2.0 TDI 8V	Diesel	103	BMM		10/05-10/10		DSN3008	12	1.7	
2.0 TFSI	Petrol	136/147	BWA1	MTM	05/05-03/09		DSN3005	12	1.1	
2.0 TFSI	Petrol	155	CCZB	6MTM	06/09-12/12	- SS	DSN3005	12	1.1	
2.0 TFSI	Petrol	177	BWJ;CDLD	ATM	11/06-05/11		DSN3005	12	1.1	
LEON (5F) (12-)										
1.0 TSI	Petrol	85	CHZD;DKRF	ATM	05/15-	+ SS	DSN1465	12	1.5	
1.0 TSI	Petrol	85	CHZD;DKRF	MTM	05/15-	+ SS	DSN1466	12	1.5	
1.2 TSI 16V	Petrol	63	CJZB;CYVA	5MTM	12/12-	MY: >2015;BO;+ SS	DSN1468	12	1.5	
1.2 TSI 16V	Petrol	63	CJZB;CYVA	6MTM	12/12-	MY: 2016->;BO;+ SS	DSN1467	12	2.0	
1.2 TSI 16V	Petrol	63/77/81	CJZA;CJZB;CYVA;CYVB	ATM	12/12-	BO;+ SS	DSN1465	12	1.5	
1.2 TSI 16V	Petrol	77/81	CJZA;CYVB	MTM	01/13-	BO;+ SS	DSN1467	12	2.0	
1.4 TGI	Petrol/ Compressed Natural Gas (CNG)	81	CPWA	6ATM	02/13-	BO;+ SS	DSN1464	12	1.5	
1.4 TGI	Petrol/ Compressed Natural Gas (CNG)	81	CPWA	Automatic Transmission, 7-speed	02/13-	BO;+ SS	DSN1465	12	1.5	
1.4 TGI	Petrol/ Compressed Natural Gas (CNG)	81	CPWA	MTM	05/17-	+ SS	DSN1466	12	1.5	
1.4 TSI	Petrol	90/92/ 103/110	CHPA;CMBA;CPTA; CXSA;CZCA;CZDA; CZEA	MTM	09/12-	+ SS	DSN1466	12	1.5	
1.4 TSI	Petrol	90/92/ 103/110	CHPA;CMBA;CPTA; CXSA;CZCA;CZDA; CZEA	6ATM	09/12-	BO;+ SS	DSN1464	12	1.5	
1.4 TSI	Petrol	90/92/ 103/110	CHPA;CMBA;CPTA; CXSA;CZCA;CZDA; CZEA	Automatic Transmission, 7-speed	09/12-	BO;+ SS	DSN1465	12	1.5	
1.5 TSI	Petrol	96	DACA;DPBA		09/18-	+ SS	DSN1464	12	1.5	
1.5 TSI	Petrol	110	DADA;DPCA		09/18-	MY: >2016;+ SS	DSN1462	12	2.0	
1.6 TDI	Diesel	66	CLHB;CXXA;DDYB		11/12-	MY: 2015->;+ SS	DSN1462	12	2.0	
1.6 TDI	Diesel	66/77/ 81/85	CLHA;CLHB;CRKB; CXXA;CXXB;DBKA; DDYA;DDYB;DGTE	ATM	11/12-	BO;VA;+ SS	DSN1463	12	2.0	
1.6 TDI	Diesel	66/77/ 81/85	CLHA;CLHB;CRKB; CXXA;CXXB;DBKA; DDYA;DDYB;DGTE	MTM	11/12-	BO;VA;+ SS	DSN1462	12	2.0	
1.6 TDI 4Drive	Diesel	77/81	CLHA;CXXB	MTM	04/14-	BO;VA;+ SS	DSN1461	12	2.0	
1.8 TSI	Petrol	132	CJSA	6ATM	02/13-	BO;+ SS	DSN1464	12	1.5	











										
SEAT continued										
LEON (5F) (12-) continued										
1.8 TSI	Petrol	132	CJSA	Automatic Transmission, 7-speed	02/13-		BO;+ SS	DSN1465	12	1.5
1.8 TSI	Petrol	132	CJSA	MTM	11/16-		+ SS	DSN1466	12	1.5
1.8 TSI 4Drive	Petrol	132	CJSA;CJSB	6ATM	11/14-		BO;+ SS	DSN1464	12	1.5
1.8 TSI 4Drive	Petrol	132	CJSA;CJSB	MTM	11/16-		+ SS	DSN1466	12	1.5
2.0 Cupra	Petrol	195/206/213/221	CJXA;CJXC;CJXE;CJXH;DNUC	ATM	10/13-		BO;+ SS	DSN1464	12	1.5
2.0 Cupra	Petrol	195/206/213/221	CJXA;CJXC;CJXE;CJXH;DNUC	MTM	10/13-		BO;+ SS	DSN1468	12	1.5
2.0 Cupra 4Drive	Petrol	221	CJXC;DNUC	ATM	11/16-		BO;+ SS	DSN1464	12	1.5
2.0 Cupra 4Drive	Petrol	221	CJXC;DNUC	MTM	11/16-		BO;+ SS	DSN1468	12	1.5
2.0 TDI	Diesel	81/105/110/135	CKFC;CRBC;CRLB;CRLD;CRMB;CRVA;CRVC;CUNA;CUPA;DFFA;DFGA;DJGA	ATM	09/12-		BO;VA;+ SS	DSN1460	12	2.0
2.0 TDI	Diesel	81/105/110/135	CKFC;CRBC;CRLB;CRLD;CRMB;CRVA;CRVC;CUNA;CUPA;DFFA;DFGA;DJGA	MTM	09/12-		BO;VA;+ SS	DSN1461	12	2.0
2.0 TDI 4Drive	Diesel	110/135	CRBC;CRLB;CRMB;CUNA;DCYA;DFGA;DJGA	ATM	04/14-		BO;VA;+ SS	DSN1460	12	2.0
2.0 TDI 4Drive	Diesel	110/135	CRBC;CRLB;CRMB;CUNA;DCYA;DFGA;DJGA	MTM	04/14-		BO;VA;+ SS	DSN1461	12	2.0
MII (KF1) (11-)										
1.0	Petrol	44/55	CHYA;CHYB	MTM	10/11-07/19		BO;+ SS	DSN1468	12	1.5
1.0 EcoFuel	Petrol/Compressed Natural Gas(CNG)	50	CPGA	MTM	10/12-07/19		BO;+ SS	DSN1468	12	1.5
TARRACO (KN2) (18-)										
1.5 TSI ACT	Petrol	110	DADA;DPCA		09/18-		MY: >2016;+ SS	DSN1462	12	2.0
TOLEDO III (5P) (04-09)										
1.4 16V	Petrol	63	BXW		05/06-05/09			DSN3006	12	1
1.6	Petrol	75	BGU;BSE;BSF;CCSA		10/04-05/09			DSN3005	12	1.1
1.9 TDI	Diesel	77	BJB;BKC;BLS;BXE		10/04-05/09			DSN3007	12	1.7
2.0 FSI	Petrol	110	BLR;BLY;BVY;BVZ	MTM	10/04-05/09			DSN3005	12	1.1
2.0 TDI	Diesel	100/103	AZV;BKD		04/04-05/09			DSN3008	12	1.7
2.0 TDI 8V	Diesel	103	BMM		11/05-05/09			DSN3008	12	1.7
2.0 TFSI	Petrol	147	BWA	MTM	11/05-05/09			DSN3005	12	1.1
TOLEDO IV (KG3) (12-19)										
1.2	Petrol	55	CGPC	MTM	07/12-06/15			DSN3006	12	1
1.2 TSI	Petrol	63	CBZA		07/12-06/15		- SS	DSN3006	12	1
1.2 TSI 16V	Petrol	66/81	CJZC;CJZD	ATM	05/15-05/17		BO;+ SS	DSN1465	12	1.5
1.2 TSI 16V	Petrol	66/81	CJZC;CJZD	MTM	05/15-05/17		BO;+ SS	DSN1468	12	1.5
1.4 TDI	Diesel	66	CUSB	ATM	05/15-04/19		BO;VA;+ SS	DSN1463	12	2.0
1.4 TDI	Diesel	66	CUSB	MTM	05/15-04/19		BO;VA;+ SS	DSN1462	12	2.0
1.4 TSI	Petrol	92	CZCA	ATM	05/15-04/19		BO;+ SS	DSN1465	12	1.5
1.6	Petrol	77	CFNA		07/13-06/15		- SS	DSN3005	12	1.1
1.6 TDI	Diesel	66/77/85	CAYB;CAYC;CLNA;CXMA	MTM	07/12-04/19		BO;VA;+ SS	DSN1462	12	2.0
SKODA										
CITIGO (11-)										
1.0	Petrol	44/55	CHYA;CHYB	MTM	10/11-08/19		BO;+ SS	DSN1468	12	1.5
1.0 CNG	CNG	50	CPGA	MTM	11/12-08/19		BO;+ SS	DSN1468	12	1.5
FABIA I (6Y) (99-08)										
1.2	Petrol	40/47	AZQ;BMD;BME	MTM	07/01-03/08			DSN3006	12	1
1.4	Petrol	55	BKY		05/04-12/07			DSN3006	12	1
1.4 16V	Petrol	55	BKY		10/99-03/08			DSN3006	12	1
1.4 16V	Petrol	59/74	BBZ;BUD	MTM	12/99-03/08			DSN3006	12	1
1.4 TDI	Diesel	55/59	AMF;BNV		04/03-03/08			DSN3007	12	1.7
1.9 TDI	Diesel	74	AXR		01/00-03/08			DSN3007	12	1.7
FABIA II (06-14)										
1.2	Petrol	44/51	BBM;BZG	MTM	12/06-12/14			DSN3006	12	1
1.2 TDI	Diesel	55	CFWA	MTM	05/10-12/14		BO;VA;- SS	DSN963	12	2.0
1.2 TDI	Diesel	55	CFWA	MTM	05/10-12/14		BO;VA;+ SS	DSN1462	12	2.0

										
SKODA continued										
FABIA II (06-14) continued										
1.2 TSI	Petrol	63	CBZA		03/10-12/14	- SS	DSN3006	12	1	
1.2 TSI	Petrol	77	CBZB	MTM	03/10-12/14	- SS	DSN3006	12	1	
1.4	Petrol	63	BXW		01/07-12/14		DSN3006	12	1	
1.4 TDI	Diesel	59	BMS;BNV	MTM	01/07-03/10		DSN3007	12	1.7	
1.6	Petrol	77	BTS	ATM	04/07-12/14		DSN3005	12	1.1	
1.6 TDI	Diesel	55/66/77	CAYA;CAYB;CAYC	MTM	03/10-12/14	BO;VA;- SS	DSN963	12	2.0	
1.6 TDI	Diesel	55/66/77	CAYA;CAYB;CAYC	MTM	03/10-12/14	BO;VA;+ SS	DSN1462	12	2.0	
1.9 TDI	Diesel	77	BLS;BSW		04/07-03/10		DSN3007	12	1.7	
FABIA III (NJ) (14-)										
1.0	Petrol	44/55	CHYA;CHYB;CHYE	MTM	08/14-	BO;+ SS	DSN1468	12	1.5	
1.0 TSI	Petrol	70/81	CHZB;CHZC;DKLD;DKRC	ATM	08/14-	BO;+ SS	DSN1465	12	1.5	
1.0 TSI	Petrol	70/81	CHZB;CHZC;DKLD;DKRC	MTM	08/14-	BO;+ SS	DSN1468	12	1.5	
1.2 TSI 16V	Petrol	66/81	CJZC;CJZD	ATM	08/14-	BO;+ SS	DSN1465	12	1.5	
1.2 TSI 16V	Petrol	66/81	CJZC;CJZD	MTM	08/14-	BO;+ SS	DSN1468	12	1.5	
1.4 TDI	Diesel	55	CUSA	MTM	05/15-	BO;VA;+ SS	DSN1462	12	2.0	
1.4 TDI	Diesel	55/66/77	CUSA;CUSB;CUTA	ATM	08/14-	BO;VA;+ SS	DSN1463	12	2.0	
1.6	Petrol	81	CWVA		01/15-	- SS	DSN1462	12	2.0	
KAROQ (NU7) (17-)										
1.0 TSI	Petrol	85	CHZJ;DKRF	MTM	07/17-	+ SS	DSN1466	12	1.5	
1.0 TSI	Petrol	85	CHZJ;DKRF	ATM	07/17-	BO;+ SS	DSN1465	12	1.5	
1.5 TSI	Petrol	110	DADA;DPCA	ATM	07/17-	BO;+ SS	DSN1465	12	1.5	
1.5 TSI	Petrol	110	DADA;DPCA	MTM	07/17-	BO;+ SS	DSN1468	12	1.5	
1.5 TSI 4x4	Petrol	110	DADA;DPCA		07/17-	MY: >2016;+ SS	DSN1462	12	2.0	
1.6 TDI	Diesel	85	DDYA;DGTE	ATM	07/17-	BO;VA;+ SS	DSN1463	12	2.0	
1.6 TDI	Diesel	85	DDYA;DGTE	MTM	07/17-	BO;VA;+ SS	DSN1462	12	2.0	
2.0 TDI 4x4	Diesel	110/140	DFFA;DFHA	ATM	07/17-	BO;VA;+ SS	DSN1460	12	2.0	
2.0 TDI 4x4	Diesel	110/140	DFFA;DFHA	MTM	07/17-	BO;VA;+ SS	DSN1461	12	2.0	
KODIAQ (NS7) (17-)										
1.4 TSI	Petrol	92/110	CZCA;CZDA;CZEA	MTM	10/16-	BO;+ SS	DSN1468	12	1.5	
1.4 TSI 4x4	Petrol	110	CZDA;CZEA	ATM	10/16-	BO;+ SS	DSN1464	12	1.5	
1.4 TSI 4x4	Petrol	110	CZDA;CZEA	MTM	10/16-	BO;+ SS	DSN1468	12	1.5	
1.5 TSI	Petrol	110	DADA;DPCA		07/18-	MY: >2016;+ SS	DSN1462	12	2.0	
2.0 RS Bi-TDI 4x4	Diesel	176	CUAA		11/18-	- SS;+ Co	DSN1464	12	1.5	
2.0 TDI	Diesel	110	DBGA;DBGC;DFGA;DTSB	ATM	10/16-	BO;VA;+ SS	DSN1460	12	2.0	
2.0 TDI	Diesel	110	DBGA;DBGC;DFGA;DTSB	MTM	10/16-	BO;VA;+ SS	DSN1461	12	2.0	
2.0 TDI 4x4	Diesel	110/140	DBGA;DBGC;DFGA;DFHA;DTSB	ATM	10/16-	BO;VA;+ SS	DSN1460	12	2.0	
2.0 TDI 4x4	Diesel	110/140	DBGA;DBGC;DFGA;DFHA;DTSB	MTM	10/16-	BO;VA;+ SS	DSN1461	12	2.0	
2.0 TSI 4x4	Petrol	132	CZPA		10/16-	Ch No: TMBZZ55ZJN000 001 >>>;+ SS	DSN1461	12	2.0	
OCTAVIA II (1Z) (04-13)										
1.4	Petrol	55/59	BCA;BUD	MTM	05/04-06/13		DSN3006	12	1	
1.6	Petrol	75	BGU;BSE;BSF;CCSA	ATM	06/04-06/13		DSN3005	12	1.1	
1.6 FSI	Petrol	85	BLF	ATM	02/04-10/08		DSN3005	12	1.1	
1.6 MultiFuel	Flexfuel	75	CCSA		01/08-06/13		DSN3005	12	1.1	
1.6 TDI	Diesel	77	CAYC	5MTM	06/09-04/13	BO;VA;- SS	DSN963	12	2.0	
1.6 TDI	Diesel	77	CAYC	5MTM	06/09-04/13	BO;VA;+ SS	DSN1462	12	2.0	
1.6 TDI 4x4	Diesel	77	CAYC	5MTM	06/09-02/13	BO;VA;- SS	DSN963	12	2.0	
1.6 TDI 4x4	Diesel	77	CAYC	5MTM	06/09-02/13	BO;VA;+ SS	DSN1462	12	2.0	
1.8 TSI 4x4	Petrol	112	CDAB	ATM	03/09-02/13		DSN3005	12	1.1	
1.9 TDI	Diesel	77	BJB;BKC;BLS;BXE		06/04-12/10		DSN3007	12	1.7	
2.0 FSI	Petrol	110	BLR;BLY;BVY;BVZ	MTM	11/04-10/08		DSN3005	12	1.1	
2.0 TDI	Diesel	81	CLCA		03/10-06/13	BO;VA;- SS	DSN963	12	2.0	
2.0 TDI	Diesel	100	AZV		02/04-05/10		DSN3008	12	1.7	
2.0 TDI	Diesel	103	BKD	ATM	02/04-05/13		DSN3008	12	1.7	
2.0 TDI 4x4	Diesel	103	BKD	6ATM	05/10-02/13		DSN3008	12	1.7	
2.0 TDI 8V	Diesel	103	BMM		11/05-05/10		DSN3008	12	1.7	
2.0 TDI 8V 4x4	Diesel	103	BMM		07/06-05/10		DSN3008	12	1.7	
2.0 TDI RS	Diesel	125	BMN		04/06-02/13		DSN3008	12	1.7	
OCTAVIA III (5E) (12-)										
1.0 TSI	Petrol	85	CHZD;DKRA;DKRF	MTM	05/16-	+ SS	DSN1466	12	1.5	
1.0 TSI	Petrol	85	CHZD;DKRA;DKRF	ATM	05/16-	BO;+ SS	DSN1465	12	1.5	
1.2 TSI 16V	Petrol	63/77/81	CJZA;CJZB;CYVA;CYVB	ATM	11/12-	BO;+ SS	DSN1465	12	1.5	

											
SKODA continued											
OCTAVIA III (5E) (12-) continued											
1.2 TSI 16V	Petrol	63/77/81	CJZA;CJZB;CYVA;CYVB	MTM	11/12-	BO;+ SS		DSN1467	12	2.0	
1.4 TSI	Petrol	103/110	CHPA;CHPB;CZDA	ATM	11/12-	BO;+ SS		DSN1465	12	1.5	
1.4 TSI G-TEC	Petrol/ Compressed Natural Gas(CNG)	81	CPWA	ATM	11/13-	BO;+ SS		DSN1465	12	1.5	
1.5 TSI	Petrol	110	DADA;DPCA	ATM	02/17-	BO;+ SS		DSN1465	12	1.5	
1.6	Petrol	81	CWVA	MTM; ATM	01/14-	BO;+ SS		DSN1468	12	1.5	
1.6 TDI	Diesel	66/77/81	CLHA;CLHB;CRKB;CXXB;DBKA	MTM	11/12-	BO;VA;+ SS		DSN1462	12	2.0	
1.6 TDI	Diesel	66/77/ 81/85	CLHA;CLHB;CRKA;CRKB;CXXA;CXXB;DBKA;DDYA;DDYB;DGT;DGTE	ATM	11/12-	BO;VA;+ SS		DSN1463	12	2.0	
1.6 TDI	Diesel	81	CRKB;CXXB;DBKA	MTM	05/13-	Eng No: DBKA>;+ SS		DSN1461	12	2.0	
1.6 TDI 4x4	Diesel	77/81	CLHA;CRKB;CXXB;DBKA	MTM	11/12-	BO;VA;+ SS		DSN1461	12	2.0	
1.8 TSI	Petrol	132	CJSA;CJSB	ATM	11/12-	BO;+ SS		DSN1465	12	1.5	
1.8 TSI 4x4	Petrol	132	CJSB	ATM	11/12-	BO;+ SS		DSN1464	12	1.5	
2.0 TDI	Diesel	105/110	CKFB;CKFC;CRMB;CRVC;CYKA;DCYA;DFFA	ATM	11/12-	BO;VA;+ SS		DSN1460	12	2.0	
2.0 TDI	Diesel	105/110	CKFB;CKFC;CRMB;CRVC;CYKA;DCYA;DFFA	MTM	11/12-	BO;VA;+ SS		DSN1461	12	2.0	
2.0 TDI 4x4	Diesel	110	CKFC;CRMB;DCYA;DFFA	ATM	11/12-	BO;VA;+ SS		DSN1460	12	2.0	
2.0 TDI 4x4	Diesel	110	CKFC;CRMB;DCYA;DFFA	MTM	11/12-	BO;VA;+ SS		DSN1461	12	2.0	
2.0 TDI RS	Diesel	135	CUNA;CUPA;DJGA	ATM	05/13-	BO;VA;+ SS		DSN1460	12	2.0	
2.0 TDI RS	Diesel	135	CUNA;CUPA;DJGA	MTM	05/13-	BO;VA;+ SS		DSN1461	12	2.0	
2.0 TDI RS 4x4	Diesel	135	CUNA;CUPA;DJGA	ATM	05/13-	BO;VA;+ SS		DSN1460	12	2.0	
2.0 TDI RS 4x4	Diesel	135	CUNA;CUPA;DJGA	MTM	05/13-	BO;VA;+ SS		DSN1461	12	2.0	
2.0 TSI RS	Petrol	162	CHHB	MTM	11/12-	BO;+ SS		DSN1468	12	1.5	
2.0 TSI RS	Petrol	162/169	CHHA;CHHB	ATM	11/12-	BO;+ SS		DSN1464	12	1.5	
RAPID (HN) (12-19)											
1.0 TSI	Petrol	70/81	CHZB;CHZC;DKLD;DKRC	ATM	06/17-12/19	BO;+ SS		DSN1465	12	1.5	
1.0 TSI	Petrol	70/81	CHZB;CHZC;DKLD;DKRC	MTM	06/17-12/19	BO;+ SS		DSN1468	12	1.5	
1.2	Petrol	55	CGPC	MTM	07/12-06/15	BO;+ SS		DSN1468	12	1.5	
1.2	Petrol	55	CGPC	MTM	07/12-06/15	BO;VA;- SS		DSN3006	12	1	
1.2 TSI	Petrol	63	CBZA	MTM	07/12-05/15	BO;VA;- SS		DSN3006	12	1	
1.2 TSI	Petrol	63/77	CBZA;CBZB	MTM	07/12-05/15	BO;+ SS		DSN1468	12	1.5	
1.2 TSI 16V	Petrol	66/81	CJZC;CJZD	MTM	05/15-12/19	BO;+ SS		DSN1468	12	1.5	
1.4 TDI	Diesel	66	CUSB	ATM	05/15-12/19	BO;VA;+ SS		DSN1463	12	2.0	
1.4 TDI	Diesel	66	CUSB	MTM	05/15-12/19	BO;VA;+ SS		DSN1462	12	2.0	
1.4 TSI	Petrol	90/92	CAXA;CZCA	ATM	07/12-12/19	BO;+ SS		DSN1465	12	1.5	
1.6	Petrol	77	CFNA		07/12-06/15	- SS		DSN3006	12	1	
1.6 SRE	Petrol	81	CWVA		05/15-12/19	- SS		DSN1462	12	2.0	
1.6 TDI	Diesel	66/77	CAYB;CAYC;CLNA	MTM	07/12-12/19	BO;VA;- SS		DSN963	12	2.0	
1.6 TDI	Diesel	66/77/85	CAYB;CAYC;CLNA;CXMA	MTM	07/12-12/19	BO;VA;+ SS		DSN1462	12	2.0	
1.6 TDI	Diesel	77/85	CLNA;CXMA	ATM	07/12-12/19	BO;VA;+ SS		DSN1463	12	2.0	
ROOMSTER (5J) (06-15)											
1.2	Petrol	51	BZG	MTM	01/07-05/15			DSN3006	12	1	
1.2 TDI	Diesel	55	CFWA	MTM	03/10-05/15	BO;VA;- SS		DSN963	12	2.0	
1.2 TDI	Diesel	55	CFWA	MTM	03/10-05/15	BO;VA;+ SS		DSN1462	12	2.0	
1.2 TSI	Petrol	63	CBZA		03/10-05/15	- SS		DSN3006	12	1	
1.2 TSI	Petrol	77	CBZB	MTM	03/10-05/15	- SS		DSN3006	12	1	
1.4	Petrol	63	BXW		09/06-05/15			DSN3006	12	1	
1.4 TDI	Diesel	59	BMS;BNV	MTM	09/06-03/10			DSN3007	12	1.7	
1.6	Petrol	77	BTS	ATM	09/06-05/15			DSN3005	12	1.1	
1.6 TDI	Diesel	66/77	CAYB;CAYC	MTM	03/10-05/15	BO;VA;- SS		DSN963	12	2.0	
1.6 TDI	Diesel	66/77	CAYB;CAYC	MTM	03/10-05/15	BO;VA;+ SS		DSN1462	12	2.0	
1.9 TDI	Diesel	74/77	AXR;BLS;BSW		03/06-03/10			DSN3007	12	1.7	
SUPERB I (3U) (01-08)											
1.9 TDI	Diesel	74/77/96	AVB;AVF;BSV		12/01-03/08			DSN3015	12	1.8	











										
SKODA continued										
SUPERB II (3T) (08-15)										
1.6 TDI	Diesel	77	CAYC	5MTM	09/10-05/15	BO;VA;- SS	DSN963	12	2.0	
1.6 TDI	Diesel	77	CAYC	ATM	09/10-05/15	BO;VA;+ SS	DSN1463	12	2.0	
1.6 TDI	Diesel	77	CAYC	MTM	09/10-05/15	BO;VA;+ SS	DSN1462	12	2.0	
1.8 TSI 4x4	Petrol	112	CDAB	ATM	03/09-05/15		DSN3005	12	1.1	
1.9 TDI	Diesel	77	BLS;BXE		03/08-11/10		DSN3007	12	1.7	
2.0 TDI	Diesel	103/125	CFFB;CFGB;CLJA	ATM	02/10-05/15	BO;VA;+ SS	DSN1460	12	2.0	
2.0 TDI	Diesel	103/125	CFFB;CFGB;CLJA	MTM	02/10-05/15	BO;VA;+ SS	DSN1461	12	2.0	
2.0 TDI 4x4	Diesel	103/125	CFFB;CFGB	ATM	05/10-05/15	BO;VA;+ SS	DSN1460	12	2.0	
2.0 TDI 4x4	Diesel	103/125	CFFB;CFGB	MTM	05/10-05/15	BO;VA;+ SS	DSN1461	12	2.0	
2.0 TDI 8V	Diesel	103	BMP	ATM	03/08-05/10		DSN3008	12	1.7	
3.6 FSI 4x4	Petrol	191	CDVA	ATM	11/08-05/15		DSN3008	12	1.7	
3.6 V6 4x4	Petrol	191	CDVA	ATM	10/09-05/15		DSN3008	12	1.7	
SUPERB III (3V) (15-)										
1.4 TSI	Petrol	92/110	CZCA;CZDA;CZEA	MTM	03/15-	+ SS	DSN1466	12	1.5	
1.4 TSI	Petrol	92/110	CZCA;CZDA;CZEA	ATM	03/15-	BO;+ SS	DSN1465	12	1.5	
1.4 TSI 4x4	Petrol	110	CZEA	ATM	03/15-	BO;+ SS	DSN1465	12	1.5	
1.4 TSI 4x4	Petrol	110	CZEA	MTM	03/15-	BO;+ SS	DSN1468	12	1.5	
1.6 TDI	Diesel	88	DCXA;DCZA	ATM	03/15-	BO;VA;+ SS	DSN1463	12	2.0	
1.6 TDI	Diesel	88	DCXA;DCZA	MTM	03/15-	BO;VA;+ SS	DSN1462	12	2.0	
1.8 TSI	Petrol	132	CJSA;CJSC	MTM	03/15-	BO;+ SS	DSN1468	12	1.5	
2.0 TDI	Diesel	110/140	CRLB;DDAA;DFCA; DFEA;DFGA;DFHA; DSRA;DSRB	ATM	03/15-	BO;VA;+ SS	DSN1460	12	2.0	
2.0 TDI	Diesel	110/140	CRLB;DDAA;DFCA; DFEA;DFGA;DFHA; DSRA;DSRB	MTM	03/15-	BO;VA;+ SS	DSN1461	12	2.0	
2.0 TDI 4x4	Diesel	110/140	CRLB;DDAA;DFCA; DFEA;DFGA;DFHA	ATM	03/15-	BO;VA;+ SS	DSN1460	12	2.0	
2.0 TDI 4x4	Diesel	110/140	CRLB;DDAA;DFCA; DFEA;DFGA;DFHA	MTM	03/15-	BO;VA;+ SS	DSN1461	12	2.0	
2.0 TSI	Petrol	162	CHHB	ATM	03/15-	BO;+ SS	DSN1464	12	1.5	
2.0 TSI	Petrol	162	CHHB	MTM	03/15-	BO;+ SS	DSN1468	12	1.5	
2.0 TSI 4x4	Petrol	206	CJXA;DNFE	ATM	03/15-	BO;+ SS	DSN1464	12	1.5	
YETI (5L) (09-17)										
1.2 TSI	Petrol	77	CBZB	ATM	09/09-05/15	BO;+ SS	DSN1465	12	1.5	
1.2 TSI	Petrol	77	CBZB	MTM	09/09-05/15	BO;+ SS	DSN1466	12	1.5	
1.2 TSI 16V	Petrol	81	CYVB	ATM	05/15-12/17	BO;+ SS	DSN1465	12	1.5	
1.2 TSI 16V	Petrol	81	CYVB	MTM	05/15-12/17	BO;+ SS	DSN1466	12	1.5	
1.4 TSI	Petrol	90/92	CAXA;CZCA	ATM	06/10-12/17	BO;+ SS	DSN1465	12	1.5	
1.4 TSI	Petrol	90/92	CAXA;CZCA	MTM	06/10-12/17	BO;+ SS	DSN1466	12	1.5	
1.4 TSI 4x4	Petrol	110	CZDA	ATM	05/15-12/17	BO;+ SS	DSN1465	12	1.5	
1.4 TSI 4x4	Petrol	110	CZDA	MTM	05/15-12/17	BO;+ SS	DSN1468	12	1.5	
1.6 TDI	Diesel	77	CAYC	ATM	11/10-05/15	BO;VA;+ SS	DSN1463	12	2.0	
1.6 TDI	Diesel	77	CAYC	MTM	11/10-05/15	BO;VA;+ SS	DSN1462	12	2.0	
1.8 TSI 4x4	Petrol	112	CDAB	ATM	11/09-12/17		DSN3005	12	1.1	
2.0 TDI	Diesel	81	CFHA;CLCA;CUUA; DFSA	MTM	11/13-12/17	Eng No: CFHA;CLCA>; BO;VA;+ SS	DSN1461	12	2.0	
2.0 TDI	Diesel	81/103/ 110	CFHA;CFHC;CLCA; CLCB;CUUA;CUUB; DFSA;DFSB	ATM	11/11-12/17	BO;VA;+ SS	DSN1460	12	2.0	
2.0 TDI	Diesel	81/103/ 110	CFHA;CFHC;CLCA; CLCB;CUUA;CUUB; DFSA;DFSB	MTM	11/11-12/17	BO;VA;+ SS	DSN1461	12	2.0	
2.0 TDI 4x4	Diesel	81/103/ 110/125	CFHC;CFHF;CFJA; CLCB;CUUA;CUUB; DFSA;DFSB	ATM	05/09-12/17	BO;VA;+ SS	DSN1460	12	2.0	
2.0 TDI 4x4	Diesel	81/103/ 110/125	CFHC;CFHF;CFJA; CLCB;CUUA;CUUB; DFSA;DFSB	MTM	05/09-12/17	BO;VA;+ SS	DSN1461	12	2.0	
SSANGYONG										
KORANDO (96-06)										
3.2	Petrol	154/156/ 162	M 104.992;M 104.995		12/96-11/06		DSN3011	12	2.2	
MUSSO (93-07)										
3.2	Petrol	162	M 104.992		06/96-09/04		DSN3011	12	2.2	
SUBARU										
FORESTER (13-)										
2.0 i AWD	Petrol	110	FB20	ATM	03/13-	+ SS;CVT	DSN1487	12	1.7	
IMPREZA (11-)										
1.6 AWD	Petrol	85	FB16A;FB16B	ATM	06/12-09/16	+ SS;CVT	DSN1487	12	1.7	
1.6 i	Petrol	84	FB16A;FB16B	ATM	06/12-09/16	+ SS;CVT	DSN1487	12	1.7	











									
SUBARU continued									
IMPREZA (11-) continued									
1.6 i AWD	Petrol	84	FB16B	ATM	06/12-	+ SS;CVT	DSN1487	12	1.7
2.0 AWD	Petrol	110	FB20	ATM	01/12-	+ SS;CVT	DSN1487	12	1.7
XV (12-)									
1.6 i AWD	Petrol	84	FB16A;FB16B	ATM	03/12-	+ SS;CVT	DSN1487	12	1.7
2.0 i AWD	Petrol	110	FB20B	ATM	03/12-	+ SS;CVT	DSN1487	12	1.7
SUZUKI									
SX4 (06-)									
1.9 DDiS	Diesel	88	D19AA		06/06-		DSN3018	12	2
1.9 DDiS 4x4	Diesel	88	D19AA		06/06-		DSN3018	12	2
TATA									
INDIGO (03-)									
1.4	Petrol	66	350 A1.000		08/09-12/14		DSN3018	12	2
TOYOTA									
AURIS (E15) (06-12)									
1.33 Dual-VVTi	Petrol	74	1NR-FE		05/09-09/12	- SS	DSN949	12	1.3
1.33 Dual-VVTi	Petrol	74	1NR-FE		05/09-09/12	+ SS	DSN986	12	1.6
1.4	Petrol	71	4ZZ-FE		03/07-12/08		DSN921	12	1.0
1.4 D-4D	Diesel	66	1ND-TV		03/07-12/08	JPN	DSN926	12	2.0
1.4 D-4D	Diesel	66	1ND-TV		03/07-02/09	EUR	DSN926	12	2.0
1.4 D-4D	Diesel	66	1ND-TV		12/08-08/12	+ Co;JPN	DSN946	12	2
1.4 D-4D	Diesel	66	1ND-TV		02/09-09/12	+ Co;EUR	DSN946	12	2
1.6	Petrol	91/97	1ZR-FAE;1ZR-FE		03/07-08/12	JPN	DSN1213	12	1.0
1.8	Petrol	106/108	2ZR-FAE		02/09-10/09	JPN	DSN1213	12	1.0
1.8 4WD	Petrol	100	2ZR-FE		10/06-10/09	JPN	DSN1213	12	1.0
2.0 D-4D	Diesel	93	1AD-FTV		10/06-09/12		DSN984	12	2
2.2 D	Diesel	130	2AD-FHV		11/06-09/12		DSN984	12	2
AURIS (E18) (12-18)									
1.2	Petrol	85	8NR-FTS	6MTM	03/15-12/18	+ SS	DSN1475	12	1.7
1.3	Petrol	73	1NR-FE		10/12-12/18	- SS	DSN1009	12	1.2
1.4 D-4D	Diesel	66	1ND-TV		10/12-12/18	- SS;+ Co	DSN1234	12	2.0
1.4 D-4D	Diesel	66	1ND-TV		10/12-12/18	+ SS	DSN1238	12	1.7
2.0 D-4D	Diesel	91	1AD-FTV		10/12-04/15		DSN989	12	1.9
AVENSIS (97-03)									
1.6	Petrol	81	3ZZ-FE		07/00-02/03		DSN921	12	1.0
1.8	Petrol	95	1ZZ-FE		10/00-02/03		DSN921	12	1.0
2.0	Petrol	94	3S-FE		09/97-07/00		DSN923	12	1.2
2.0	Petrol	94/110	1AZ-FSE;3S-FE		07/00-02/03	+ Co	DSN922	12	1.2
2.0 D	Diesel	61	2C-T	MTM	10/97-05/98		DSN950	12	2
2.0 D	Diesel	85	1CD-FTV		09/02-02/03		DSN950	12	2
2.0 D-4D	Diesel	81	1CD-FTV		10/99-02/03		DSN950	12	2
2.0 TD	Diesel	66	2C-TE		09/97-02/03		DSN950	12	2
2.0 VVT-i	Petrol	110	1AZ-FSE		10/00-02/03	+ Co	DSN922	12	1.2
AVENSIS (03-09)									
1.6 VVT-i	Petrol	81	3ZZ-FE		04/03-11/08		DSN920	12	1.3
1.8	Petrol	95	1ZZ-FE		03/03-11/08		DSN920	12	1.3
2.0	Petrol	108	1AZ-FSE		03/03-11/08		DSN1370	12	1.6
2.0 D-4D	Diesel	85	1CD-FTV		04/03-04/06		DSN950	12	2
2.0 D-4D	Diesel	93	1AD-FTV		03/06-11/08		DSN984	12	2
2.0 VVTi	Petrol	114	1AZ-FE		01/03-11/08		DSN1370	12	1.6
2.2 D-4D	Diesel	110	2AD-FTV		10/05-11/08		DSN984	12	2
2.2 D-CAT	Diesel	130	2AD-FHV		07/05-11/08		DSN984	12	2
2.4	Petrol	120/125	2AZ-FSE		09/03-11/08		DSN1370	12	1.6
AVENSIS (08-18)									
2.0 D-4D	Diesel	91/93	1AD-FTV		11/08-10/18		DSN984	12	2
2.2 D-4D	Diesel	110/130	2AD-FHV;2AD-FTV		11/08-10/18		DSN984	12	2
AVENSIS Verso (01-09)									
2.0	Petrol	110	1AZ-FE	ATM	08/01-11/09		DSN1003	12	1.7
2.0	Petrol	110	1AZ-FE	MTM	08/01-11/09		DSN929	12	1.4
2.0 D	Diesel	85	1CD-FTV		08/01-08/05		DSN928	12	2.2
2.4	Petrol	115	2AZ-FE		08/01-08/07		DSN1003	12	1.7
CAMRY (V1) (90-97)									
2.2	Petrol	100	5S-FE		08/94-07/96	JPN	DSN923	12	1.2
CAMRY (V2) (96-01)									
2.2	Petrol	93/96	5S-FE		02/97-09/02		DSN929	12	1.4
3.0 24V	Petrol	140	1MZ-FE		02/97-11/01		DSN929	12	1.4
3.0 V6	Petrol	135	1MZ-FE		02/97-11/01		DSN929	12	1.4
CAMRY (V3) (01-06)									
2.0 VVTi	Petrol	110	1AZ-FE		08/01-11/06		DSN1003	12	1.7

									
TOYOTA continued									
CAMRY (V3) (01-06) continued									
2.4	Petrol	112	2AZ-FE		11/01-11/06		DSN1003	12	1.7
3.0	Petrol	137	1MZ-FE		08/01-11/06		DSN1003	12	1.7
CAMRY (V4) (06-11)									
2.4	Petrol	116	2AZ-FE		01/06-09/11		DSN1003	12	1.7
2.4 VVTi	Petrol	123	2AZ-FE		01/06-09/11		DSN1003	12	1.7
3.5	Petrol	204	2GR-FE		09/06-12/14		DSN1003	12	1.7
CAMRY (V5) (11-)									
3.5	Petrol	204	2GR-FE		09/11-12/17		DSN1003	12	1.7
CAMRY Solara (98-03)									
3.0	Petrol	140	1MZ-FE		06/98-06/01		DSN929	12	1.4
CARINA E (92-97)									
2.0	Petrol	98	3S-FE		01/93-09/97		DSN923	12	1.2
2.0 D	Diesel	54	2C		02/94-01/96		DSN928	12	2.2
2.0 GLI	Petrol	98	3S-FE		04/92-09/97		DSN923	12	1.2
2.0 GTi	Petrol	116	3S-GE		04/92-12/95		DSN923	12	1.2
2.0 GTi 16V	Petrol	129	3S-GE		03/94-09/97		DSN923	12	1.2
2.0 i	Petrol	93	3S-FE		12/92-09/97		DSN923	12	1.2
2.0 TD	Diesel	61	2C-T		01/96-09/97		DSN950	12	2
CELICA (99-05)									
1.8 16V TS	Petrol	141	2ZZ-GE		08/99-09/05		DSN921	12	1.0
1.8 16V VT-i	Petrol	105	1ZZ-FE		08/99-07/05		DSN921	12	1.0
C-HR (16-)									
1.2	Petrol	85	8NR-FTS	6MTM	10/16-	+ SS	DSN1475	12	1.7
1.2 4WD	Petrol	85/96	8NR-FTS	6MTM	10/16-	+ SS	DSN1475	12	1.7
COROLLA (E10) (92-99)									
2.0 D	Diesel	53	2C		05/95-04/97		DSN1224	12	1.4
COROLLA (E11) (97-02)									
1.4	Petrol	71	4ZZ-FE		10/99-10/01		DSN921	12	1.0
1.4 16V	Petrol	71	4ZZ-FE		02/00-11/01		DSN921	12	1.0
1.6	Petrol	81	3ZZ-FE		10/99-10/01		DSN921	12	1.0
1.6 16V	Petrol	81	3ZZ-FE		10/99-12/01		DSN921	12	1.0
2.0 D	Diesel	53	2C-E		04/97-10/99		DSN1224	12	1.4
2.0 D-4D	Diesel	66	1CD-FTV		09/00-11/01		DSN928	12	2.2
COROLLA (E12) (01-07)									
1.4 D	Diesel	66	1ND-TV		07/04-02/07		DSN926	12	2.0
1.4 D-4D	Diesel	66	1ND-TV		06/04-02/07		DSN926	12	2.0
1.4 D4-D	Diesel	66	1ND-TV		06/04-10/07		DSN926	12	2.0
1.4 VVT-i	Petrol	71	4ZZ-FE		10/01-02/07		DSN921	12	1.0
1.6 VVT-i	Petrol	81	3ZZ-FE		10/01-12/06		DSN921	12	1.0
1.8 VTL-i TS	Petrol	141/160/165	2ZZ-GE		11/01-02/07		DSN921	12	1.0
2.0 D-4D	Diesel	66/81/85	1CD-FTV		01/02-05/04	JPN	DSN928	12	2.2
2.0 D-4D	Diesel	66/81/85	1CD-FTV		01/02-02/07	EUR	DSN950	12	2
COROLLA (E14, E15) (06-14)									
1.33	Petrol	74	1NR-FE		12/08-06/13	- SS	DSN949	12	1.3
1.33	Petrol	74	1NR-FE		12/08-06/13	+ SS	DSN986	12	1.6
1.4 D-4D	Diesel	66	1ND-TV		10/06-12/08		DSN926	12	2.0
1.4 D-4D	Diesel	66	1ND-TV		12/08-07/14	+ Co	DSN946	12	2
1.4 VVT-i	Petrol	71	4ZZ-FE		11/06-12/08		DSN921	12	1.0
1.6	Petrol	97	1ZR-FAE;1ZR-FE		11/06-04/13		DSN1213	12	1.0
1.6	Petrol	97	1ZR-FE		09/12-04/13	+ Co	DSN1239	12	1.3
1.6 Dual VVTi	Petrol	91	1ZR-FE		01/07-09/12		DSN1213	12	1.0
1.6 Dual VVTi	Petrol	91	1ZR-FE		09/12-04/13	+ Co	DSN1239	12	1.3
2.0 D-4D	Diesel	93	1AD-FTV		11/06-07/14		DSN984	12	2
COROLLA (E18) (13-18)									
1.3	Petrol	73	1NR-FE		06/13-12/18		DSN1009	12	1.2
1.4 D-4D	Diesel	66	1ND-TV		06/13-12/18	- SS;+ Co	DSN1234	12	2.0
1.4 D-4D	Diesel	66	1ND-TV		06/13-12/18	+ SS	DSN1238	12	1.7
COROLLA (E21) (18-)									
1.2	Petrol	85	8NR-FTS	6MTM	01/19-	+ SS	DSN1475	12	1.7
COROLLA Verso (E12) (01-09)									
1.6	Petrol	81	3ZZ-FE		08/01-01/04		DSN921	12	1.0
1.6	Petrol	81	3ZZ-FE		04/04-03/09		DSN920	12	1.3
1.8	Petrol	95	1ZZ-FE		04/04-03/09		DSN920	12	1.3
1.8 VVT-i	Petrol	99	1ZZ-FE		12/01-01/04		DSN921	12	1.0
2.0 D-4D	Diesel	66	1CD-FTV		01/02-01/04		DSN928	12	2.2
2.0 D-4D	Diesel	85	1CD-FTV		04/04-08/05		DSN950	12	2

Starters & Alternators











Application Tables - Starters











									
TOYOTA continued									
COROLLA Verso (E12) (01-09) continued									
2.2 D-4D	Diesel	100/130	2AD-FHV;2AD-FTV		10/05-03/09		DSN984	12	2
DYNA (01-)									
2.5 D-4D	Diesel	65/75	2KD-FTV		07/01-10/06		DSN1001	12	2
2.5 D-4D	Diesel	65/75	2KD-FTV		07/01-10/06	+ Co	DSN1229	12	2.7
3.0 D-4D	Diesel	80/100/106	1KD-FTV		09/06-		DSN1211	12	2.2
3.0 D-4D	Diesel	80/100/106	1KD-FTV		09/06-	+ Co	DSN1229	12	2.7
HIACE IV (87-12)									
2.0	Petrol	74	1RZ		08/93-08/04		DSN1225	12	1.4
2.4	Petrol	85/88	2RZ-E		08/93-08/03		DSN1225	12	1.4
2.4 4WD	Petrol	85/88	2RZ-E		08/93-04/98		DSN1225	12	1.4
2.4 i	Petrol	88	2RZ-E		08/95-07/99		DSN1225	12	1.4
2.5 D-4D	Diesel	65/75	2KD-FTV	ATM	08/01-08/06		DSN1229	12	2.7
2.5 D-4D	Diesel	65/75	2KD-FTV	MTM	08/01-08/06		DSN1001	12	2
2.5 D-4D	Diesel	70/86	2KD-FTV		09/06-12/12		DSN1001	12	2
2.5 D-4D	Diesel	70/86	2KD-FTV		09/06-12/12	+ Co	DSN1229	12	2.7
2.5 D-4D 4WD	Diesel	75	2KD-FTV	ATM	08/01-08/06		DSN1229	12	2.7
2.5 D-4D 4WD	Diesel	75	2KD-FTV	MTM	08/01-08/06		DSN1001	12	2
2.5 D-4D 4WD	Diesel	86	2KD-FTV		09/06-12/12		DSN1001	12	2
2.5 D-4D 4WD	Diesel	86	2KD-FTV		09/06-12/12	+ Co	DSN1229	12	2.7
2.7	Petrol	106	3RZ-FE		04/98-12/06		DSN1225	12	1.4
2.7 4WD	Petrol	106	3RZ-FE		04/98-08/06		DSN1225	12	1.4
HIACE V (04-)									
2.5 D-4D	Diesel	70/75/86	2KD-FTV		06/04-		DSN1001	12	2
2.5 D-4D	Diesel	70/75/86	2KD-FTV		06/04-	+ Co	DSN1229	12	2.7
2.5 D-4D 4WD	Diesel	94	2KD-FTV		09/06-09/07		DSN1001	12	2
2.5 D-4D 4WD	Diesel	94	2KD-FTV		09/06-09/07	+ Co	DSN1229	12	2.7
HILUX II (83-05)									
2.4	Petrol	107	2RZ-FE		08/97-07/05		DSN1225	12	1.4
2.4 i 4WD	Petrol	103	2RZ-FE		08/97-10/05		DSN1225	12	1.4
2.5 D-4D	Diesel	65	2KD-FTV		11/01-07/05		DSN1001	12	2
2.5 D-4D	Diesel	65	2KD-FTV		11/01-07/05	+ Co	DSN1229	12	2.7
2.5 D-4D 4WD	Diesel	75	2KD-FTV		11/01-07/05		DSN1001	12	2
2.5 D-4D 4WD	Diesel	75	2KD-FTV		11/01-07/05	+ Co	DSN1229	12	2.7
HILUX III (05-)									
2.5 D 4WD	Diesel	75	2KD-FTV		03/05-08/11		DSN1374	12	2.0
2.5 D 4WD	Diesel	75	2KD-FTV		03/05-05/15		DSN1371	12	2.7
2.5 D-4D	Diesel	65/75/88/106	2KD-FTV		03/05-08/11		DSN1374	12	2.0
2.5 D-4D	Diesel	65/75/88/106	2KD-FTV		03/05-05/15		DSN1371	12	2.7
2.5 D-4D 4WD	Diesel	88/94/106	2KD-FTV		11/04-08/11		DSN1374	12	2.0
2.5 D-4D 4WD	Diesel	88/94/106	2KD-FTV		11/04-05/15		DSN1371	12	2.7
3.0 D 4WD	Diesel	120	1KD-FTV		03/05-04/15		DSN1373	12	2.2
3.0 D 4WD	Diesel	120	1KD-FTV		03/05-05/15		DSN1371	12	2.7
3.0 D-4D 4WD	Diesel	126/145	1KD-FTV		08/05-04/15		DSN1373	12	2.2
3.0 D-4D 4WD	Diesel	126/145	1KD-FTV		08/05-09/15		DSN1371	12	2.7
HILUX IV (15-)									
2.4 D	Diesel	110	2GD-FTV	MTM	05/15-	- SS	DSN1371	12	2.7
2.4 D 4WD	Diesel	110	2GD-FTV	MTM	05/15-	- SS	DSN1371	12	2.7
IQ (09-15)									
1.0	Petrol	50	1KR-FE		01/09-12/15		DSN1221	12	0.8
1.0	Petrol	50	1KR-FE		01/09-12/15	+ Co	DSN1215	12	1
LAND CRUISER (J80) (90-98)									
4.2 D	Diesel	99	1H-Z		08/96-12/97		DSN1228	24	4.5
4.2 TD	Diesel	118/123	1HD-T		08/96-12/97		DSN1228	24	4.5
4.2 TD 24V	Diesel	125	1HD-FT		08/96-12/97		DSN1228	24	4.5
LAND CRUISER (J200) (07-)									
4.5 D V8	Diesel	210	1VD-FTV		01/08-		DSN1210	12	2.7
4.5 D-4D	Diesel	195	1VD-FTV		09/07-		DSN1210	12	2.7
4.5 D4-D	Diesel	173/200	1VD-FTV		08/07-		DSN1210	12	2.7
4.6 V8	Petrol	234	1UR-FE		01/12-		DSN1236	12	2
LAND CRUISER / PRADO (J70) (84-06)									
4.2 D	Diesel	96	1H-Z		08/96-08/99		DSN1228	24	4.5
4.2 D 4x4	Diesel	96	1H-Z		08/96-08/99		DSN1228	24	4.5











									
TOYOTA continued									
LAND CRUISER / PRADO (J120) (02-10)									
3.0 D-4D	Diesel	120/122/127	1KD-FTV	ATM	09/02-12/10		DSN1229	12	2.7
3.0 D-4D	Diesel	120/122/127	1KD-FTV	MTM	09/02-12/10		DSN1211	12	2.2
3.0 D-4D	Diesel	120/122/127	1KD-FTV	MTM	09/02-12/10	+ Co	DSN1229	12	2.7
4.0	Petrol	183	1GR-FE		12/02-12/10		DSN1220	12	1.6
4.0	Petrol	183	1GR-FE		12/02-12/10	+ Co	DSN978	12	2
LAND CRUISER / PRADO (J150) (10-)									
3.0 D-4D	Diesel	127/140	1KD-FTV		08/09-		DSN1211	12	2.2
3.0 D-4D	Diesel	127/140	1KD-FTV		08/09-	+ Co	DSN1229	12	2.7
4.0 V6 Dual VVTi	Petrol	205	1GR-FE		08/09-		DSN1241	12	1.4
4.0 V6 VVTi	Petrol	183	1GR-FE		11/12-		DSN1241	12	1.4
4.0 V6 VVT-i	Petrol	207	1GR-FE		08/09-		DSN1241	12	1.4
LAND CRUISER / PRADO / COLORADO (J90) (95-02)									
3.0 D-4D 4WD	Diesel	120	1KD-FTV		08/00-08/02		DSN1229	12	2.7
3.0 D-4D 4WD	Diesel	120	1KD-FTV	MTM	08/00-08/02		DSN1211	12	2.2
3.0 TD	Diesel	92	1KZ-TE		04/96-09/02		DSN1229	12	2.7
3.0 TD	Diesel	92	1KZ-TE	MTM	04/96-09/02		DSN1211	12	2.2
MR 2 III (99-07)									
1.8 16V VT-i	Petrol	103	1ZZ-FE		10/99-06/07		DSN921	12	1.0
PICNIC (96-01)									
2.0	Petrol	90	3S-FE		06/00-05/01		DSN923	12	1.2
2.0 16V	Petrol	94	3S-FE		08/96-05/01		DSN923	12	1.2
2.2 D	Diesel	66	3C-TE		08/97-05/01		DSN928	12	2.2
PREVIA / ESTIMA II (00-06)									
2.0 D-4D	Diesel	85	1CD-FTV		03/01-01/06		DSN928	12	2.2
2.4	Petrol	115	2AZ-FE		02/00-02/06		DSN929	12	1.4
PREVIA / ESTIMA III (05-)									
2.4	Petrol	125	2AZ-FE		10/05-		DSN1003	12	1.7
RAV 4 I / FUNCRAISER (94-00)									
2.0 4WD	Petrol	94	3S-FE		06/94-06/00		DSN923	12	1.2
2.0 4WD	Petrol	94	3S-FE	MTM	12/97-06/00		DSN923	12	1.2
RAV 4 II (00-05)									
1.8	Petrol	92	1ZZ-FE		08/00-11/05		DSN921	12	1.0
2.0 4WD	Petrol	110	1AZ-FE;1AZ-FSE		05/00-11/05		DSN929	12	1.4
2.0 D 4WD	Diesel	85	1CD-FTV		05/01-11/05		DSN928	12	2.2
RAV 4 III (05-13)									
2.0	Petrol	116	3ZR-FAE		12/08-12/12		DSN1213	12	1.0
2.0	Petrol	116	3ZR-FAE		07/11-12/12	+ RUS	DSN1239	12	1.3
2.0 4WD	Petrol	112	1AZ-FE		02/06-12/12		DSN1003	12	1.7
2.0 4WD	Petrol	116	3ZR-FAE		12/08-12/12		DSN1213	12	1.0
2.0 4WD	Petrol	116	3ZR-FAE		07/11-12/12	+ RUS	DSN1239	12	1.3
2.2 D	Diesel	110	2AD-FHV;2AD-FTV		12/08-12/12		DSN984	12	2
2.2 D 4WD	Diesel	100/110/130	2AD-FHV;2AD-FTV		02/06-12/12		DSN984	12	2
2.4	Petrol	125	2AZ-FE		11/05-12/12		DSN1003	12	1.7
3.5 4WD	Petrol	201	2GR-FE		01/07-12/12		DSN1003	12	1.7
RAV 4 IV (12-)									
2.0 4WD	Petrol	107	3ZR-FE	MTM	12/12-		DSN1213	12	1.0
2.0 4WD	Petrol	111	3ZR-FAE		12/12-		DSN1213	12	1.0
2.0 D	Diesel	91	1AD-FTV		12/12-11/18	- SS	DSN1235	12	2
2.0 D	Diesel	91	1AD-FTV		12/12-11/18	+ SS	DSN989	12	1.9
2.0 D 4WD	Diesel	91	1AD-FTV		01/13-11/18	- SS	DSN1235	12	2
2.0 D 4WD	Diesel	91	1AD-FTV		01/13-11/18	+ SS	DSN989	12	1.9
2.0 VVT-i	Petrol	107	3ZR-FAE		12/12-		DSN1213	12	1.0
2.2 D 4WD	Diesel	110	2AD-FHV;2AD-FTV		12/12-		DSN1235	12	2
2.5 4WD	Petrol	132	2AR-FE	MTM	12/12-		DSN1003	12	1.7
URBAN CRUISER (07-16)									
1.33	Petrol	74	1NR-FE		01/09-03/16	- SS	DSN949	12	1.3
1.33	Petrol	74	1NR-FE		01/09-03/16	+ SS	DSN986	12	1.6
1.4 D-4D	Diesel	66	1ND-TV		01/09-04/14	+ Co	DSN946	12	2
1.4 D-4D 4WD	Diesel	66	1ND-TV		01/09-04/14	+ Co	DSN946	12	2
VERSO (09-18)									
2.0 D-4D	Diesel	93	1AD-FTV		04/09-10/10		DSN984	12	2
2.2 D-4D	Diesel	110	2AD-FHV		04/09-10/10		DSN984	12	2
2.2 D-CAT	Diesel	130	2AD-FHV		04/09-10/10		DSN984	12	2
VERSO S (10-16)									
1.33	Petrol	73	1NR-FE		11/10-10/16	- SS	DSN1009	12	1.2











Starters & Alternators

Application Tables - Starters

									
TOYOTA continued									
VERSO S (10-16) continued									
1.33	Petrol	73	1NR-FE		11/10-10/16	+ SS	DSN987	12	1.6
1.4 D4-D	Diesel	66	1ND-TV		11/10-10/16	+ Co	DSN946	12	2
WISH (03-09)									
1.8 Hi	Petrol	97	1ZZ-FE		04/03-08/05		DSN921	12	1.0
1.8 Hi 4WD	Petrol	92	1ZZ-FE		04/03-08/05		DSN921	12	1.0
YARIS (99-05)									
1.0	Petrol	48/50	1SZ-FE		04/99-09/05		DSN931	12	1.0
1.3	Petrol	64	2NZ-FE	ATM	08/99-12/00		DSN935	12	1.4
1.3	Petrol	64	2NZ-FE	MTM	08/99-12/00		DSN934	12	1.0
1.3	Petrol	64	2NZ-FE	ATM	12/00-12/02		DSN936	12	1.6
1.3	Petrol	64	2SZ-FE		04/02-09/05		DSN931	12	1.0
1.4 D-4D	Diesel	55	1ND-TV		10/01-09/05		DSN937	12	2.0
1.5	Petrol	77/110	1NZ-FE		03/00-11/05		DSN934	12	1.0
YARIS (05-11)									
1.0 GPL	Petrol/ Liquified Petroleum Gas (LPG)	51	1KR-FE		01/06-12/11		DSN988	12	0.8
1.0 GPL	Petrol/ Liquified Petroleum Gas (LPG)	51	1KR-FE		01/06-12/11	+ Co	DSN948	12	1.3
1.0 VWT-i	Petrol	51	1KR-FE		08/05-12/11		DSN988	12	0.8
1.0 VWT-i	Petrol	51	1KR-FE		08/05-12/11	+ Co	DSN948	12	1.3
1.3 4WD	Petrol	64	2SZ-FE		08/07-11/08		DSN980	12	1.3
1.3 VWT-i	Petrol	64	2SZ-FE		08/05-11/08		DSN980	12	1.3
1.33 VWT-i	Petrol	74	1NR-FE		11/08-07/11	- SS	DSN949	12	1.3
1.33 VWT-i	Petrol	74	1NR-FE		11/08-07/11	+ SS	DSN986	12	1.6
1.4 D-4D	Diesel	66	1ND-TV		08/05-11/08		DSN926	12	2.0
1.4 D-4D	Diesel	66	1ND-TV		11/08-07/11	+ Co	DSN946	12	2
1.8 VWTi	Petrol	98	2ZR-FE		01/07-06/10		DSN1213	12	1.0
YARIS (10-)									
1.0	Petrol	51	1KR-FE		12/10-		DSN988	12	0.8
1.0	Petrol	51/53	1KR-FE		12/10-	+ Co	DSN948	12	1.3
1.3	Petrol	73	1NR-FE		09/11-06/14	+ SS	DSN987	12	1.6
1.3	Petrol	73	1NR-FE		09/11-	- SS	DSN1009	12	1.2
1.3	Petrol	73	1NR-FE	6MTM	07/14-	+ SS	DSN1472	12	1.6
1.3	Petrol	73	1NR-FE	ATM	07/14-	+ SS;CVT	DSN1473	12	1.6
1.3 4WD	Petrol	70	1NR-FE		12/10-06/14	+ SS	DSN987	12	1.6
1.3 4WD	Petrol	70	1NR-FE		12/10-	- SS	DSN1009	12	1.2
1.3 4WD	Petrol	70	1NR-FE	6MTM	07/14-	+ SS	DSN1472	12	1.6
1.3 4WD	Petrol	70	1NR-FE	ATM	07/14-	+ SS;CVT	DSN1473	12	1.6
1.4 D	Diesel	66	1ND-TV		09/11-	+ Co	DSN946	12	2
1.4 D	Diesel	66	1ND-TV		09/11-	+ SS	DSN1238	12	1.7
1.5	Petrol	82	2NR-FKE		03/17-	- SS	DSN1009	12	1.2
1.5	Petrol	82	2NR-FKE	6MTM	03/17-	+ SS	DSN1472	12	1.6
1.5	Petrol	82	2NR-FKE	ATM	03/17-	+ SS;CVT	DSN1473	12	1.6
1.5 VWTi	Petrol	82	2NR-FKE		03/17-	- SS	DSN1009	12	1.2
1.5 VWTi	Petrol	82	2NR-FKE	6MTM	03/17-	+ SS	DSN1472	12	1.6
1.5 VWTi	Petrol	82	2NR-FKE	ATM	03/17-	+ SS;CVT	DSN1473	12	1.6
YARIS (16-)									
1.3	Petrol	73	1NR-FE		04/16-	- SS	DSN1009	12	1.2
1.3	Petrol	73	1NR-FE	6MTM	04/16-	+ SS	DSN1472	12	1.6
1.3	Petrol	73	1NR-FE	ATM	04/16-	+ SS;CVT	DSN1473	12	1.6
YARIS VERSO (99-05)									
1.3	Petrol	62	2NZ-FE	ATM	08/99-12/00		DSN935	12	1.4
1.3	Petrol	62	2NZ-FE	MTM	08/99-09/05		DSN934	12	1.0
1.3	Petrol	62	2NZ-FE	ATM	12/00-09/05		DSN936	12	1.6
1.4 D-4D	Diesel	55	1ND-TV		09/00-09/05		DSN937	12	2.0
1.5	Petrol	77	1NZ-FE		03/00-09/05		DSN934	12	1.0
VAUXHALL									
AGILA I (A) (00-08)									
1.2 16V	Petrol	55	Z 12 XE		09/00-03/08		DSN3009	12	1.1
ASTRA II (84-94)									
1.2	Petrol	44	12 S		09/84-08/91		DSN3009	12	1.1
1.3	Petrol	55	13 S		09/84-08/91		DSN3009	12	1.1











									
VAUXHALL continued									
ASTRA II (84-94) continued									
1.3 N	Petrol	44	13 NB		08/85-12/89		DSN3009	12	1.1
1.3 S	Petrol	55	13 S		08/85-12/89		DSN3009	12	1.1
1.4 i	Petrol	44	C 14 NZ		01/90-12/91		DSN3009	12	1.1
1.4 S	Petrol	55	14 NV		01/89-08/91		DSN3009	12	1.1
1.6	Petrol	60	16 SV		09/84-12/91		DSN3009	12	1.1
1.6 i	Petrol	55/60	16 SV;C 16 NZ		01/87-10/94		DSN3009	12	1.1
1.6 S	Petrol	60	16 SV		01/89-12/91		DSN3009	12	1.1
ASTRA III (F) (91-01)									
1.4 i	Petrol	44/60	C 14 NZ;C 14 SE; X 14 NZ		03/91-09/98		DSN3009	12	1.1
1.6 i	Petrol	52/55/74	16 NZR;C 16 NZ; C 16 SE;E 16 NZ; X 16 SZ;X 16 SZR		09/91-12/98		DSN3009	12	1.1
1.6 i 16V	Petrol	74	X 16 XEL		01/94-09/98		DSN3009	12	1.1
1.6 Si	Petrol	74	C 16 SE		03/91-12/94		DSN3009	12	1.1
ASTRA IV (G) (98-06)									
1.4 16V	Petrol	66	X 14 XE;Z 14 XE		02/98-05/05		DSN3009	12	1.1
1.4 16V Dualfuel	Petrol/ Liquified Petroleum Gas (LPG)	66	X 14 XE;Z 14 XE		09/99-06/03		DSN3009	12	1.1
1.6	Petrol	55/62/76	X 16 SZR;Z 16 SE; Z 16 XEP		02/98-05/05		DSN3009	12	1.1
1.6 16V	Petrol	74	X 16 XEL;Z 16 XE		02/98-10/05		DSN3009	12	1.1
1.6 16V DualFuel	Petrol/ Liquified Petroleum Gas (LPG)	77	Z 16 XEP		10/04-12/05		DSN3009	12	1.1
1.6 Dualfuel	Petrol/ Liquified Petroleum Gas (LPG)	55/62/74	X 16 SZR;X 16 XEL; Z 16 SE;Z 16 XE		02/98-08/05		DSN3009	12	1.1
1.6 i	Petrol	55/62	X 16 SZR;Z 16 SE		08/98-08/06		DSN3009	12	1.1
2.0 DI	Diesel	60	X 20 DTL;Y 20 DTL		02/98-08/06		DSN3017	12	2
2.0 DTI	Diesel	74	Y 20 DTH		04/04-08/06		DSN3017	12	2
2.0 DTI 16V	Diesel	74	Y 20 DTH		02/98-05/05		DSN3017	12	2
ASTRA VI (J) (09-15)									
1.6	Petrol	85	A 16 XER;B 16 XER		12/09-10/15	+ SS	DSN1008	12	1.7
CASCADA (13-)									
2.0 CDTI	Diesel	125	B 20 DTH	MTM	07/15-	+ SS	DSN1453	12	1.9
CAVALIER III (88-95)									
1.4 S	Petrol	55	14 NV		09/88-11/95		DSN3009	12	1.1
COMBO I (B) (94-01)									
1.4	Petrol	44	C 14 NZ;X 14 SZ		07/94-10/01		DSN3009	12	1.1
COMBO II (C) (01-12)									
1.6	Petrol	62/64	Z 16 SE		09/01-11/11		DSN3009	12	1.1
1.6 CNG 16V	Petrol/ Compressed Natural Gas (CNG)	71	Z 16 YNG		04/05-02/12		DSN3009	12	1.1
CORSA I (B) (93-00)									
1.2 i	Petrol	33	C 12 NZ;X 12 SZ		03/93-09/00		DSN3009	12	1.1
1.2 i 16V	Petrol	48	X 12 XE		03/98-09/00		DSN3009	12	1.1
1.4 i	Petrol	44	C 14 NZ;X 14 SZ		03/93-09/00		DSN3009	12	1.1
1.4 i 16V	Petrol	66	X 14 XE		09/94-09/00		DSN3009	12	1.1
1.4 i S	Petrol	60	C 14 SE		03/93-09/00		DSN3009	12	1.1
1.6 GSI 16V	Petrol	80	C 16 XE		03/93-09/00		DSN3009	12	1.1
1.6 i 16V	Petrol	78	X 16 XE		09/94-09/00		DSN3009	12	1.1
CORSA II (C) (00-06)									
1.2 16V	Petrol	55	Z 12 XE		09/00-10/06		DSN3009	12	1.1
1.2 16V DualFuel	Petrol/ Liquified Petroleum Gas (LPG)	55	Z 12 XE		08/01-10/06		DSN3009	12	1.1











									
VAUXHALL continued									
CORSA II (C) (00-06) continued									
1.4 16V	Petrol	66	Z 14 XE		09/00-10/06		DSN3009	12	1.1
FRONTERA II (B) (98-04)									
2.2 DTI	Diesel	85	X 22 DTH;Y 22 DTH		10/98-09/04		DSN3017	12	2
3.2 i	Petrol	151	6VD1 (DOHC)		10/98-10/04		DSN1488	12	1.4
INSIGNIA I (A) (08-17)									
2.0 CDTI	Diesel	125	B 20 DTH	MTM	11/14-05/17		DSN1453	12	1.9
2.0 CDTI 4x4	Diesel	125	B 20 DTH	MTM	11/14-05/17		DSN1453	12	1.9
INSIGNIA II (B) (17-)									
2.0 D	Diesel	125	B 20 DTH;D 20 DTH	MTM	03/17-	+ SS	DSN1453	12	1.9
2.0 D 4x4	Diesel	125	B 20 DTH;D 20 DTH	MTM	09/17-	+ SS	DSN1453	12	1.9
MERIVA I (A) (03-10)									
1.6 i	Petrol	64	Z 16 SE		01/03-06/10		DSN3009	12	1.1
1.6 i 16V	Petrol	74	Z 16 XE		01/03-09/05		DSN3009	12	1.1
MOKKA (12-)									
1.6	Petrol	85	A 16 XER;B 16 XER; D 16 XER		06/12-	+ SS	DSN1008	12	1.7
MONTEREY I (91-98)									
3.2	Petrol	130	6VD1 (SOHC)		06/92-07/98		DSN1488	12	1.4
MONTEREY II (98-99)									
3.5 V6 24V	Petrol	158	6 VE1		07/98-08/99		DSN1488	12	1.4
OMEGA (B) (94-03)									
2.0 DTI 16V	Diesel	74	X 20 DTH		01/98-09/00		DSN3017	12	2
2.2 DTI 16V	Diesel	88	Y 22 DTH		08/00-07/03		DSN3017	12	2
SIGNUM (02-08)									
2.0 DTI	Diesel	74	Y 20 DTH		05/03-04/04		DSN3017	12	2
2.2 DTI	Diesel	92	Y 22 DTR		05/03-05/08		DSN3017	12	2
SINTRA (96-99)									
2.2 DTI	Diesel	85	X 22 DTH		07/97-04/99		DSN3017	12	2
TIGRA (94-00)									
1.4 16V	Petrol	66	X 14 XE		07/94-12/00		DSN3009	12	1.1
1.6 16V	Petrol	78	X 16 XE		07/94-12/00		DSN3009	12	1.1
VECTRA I (B) (95-03)									
1.6 i	Petrol	55	X 16 SZR		08/95-10/01		DSN3009	12	1.1
1.6 i 16V	Petrol	74	X 16 XEL;Y 16 XE; Z 16 XE		08/95-10/01		DSN3009	12	1.1
2.0 DI 16V	Diesel	60	X 20 DTL		08/95-10/01		DSN3017	12	2
2.0 DTi 16V	Diesel	74	X 20 DTH;Y 20 DTH		08/95-10/01		DSN3017	12	2
2.2 DTI 16V	Diesel	92	Y 22 DTR		08/95-10/01		DSN3017	12	2
VECTRA II (C) (00-08)									
2.0 DTI 16V	Diesel	74	Y 20 DTH		04/02-10/08		DSN3017	12	2
2.2 DTI 16V	Diesel	92	Y 22 DTR		04/02-10/08		DSN3017	12	2
ZAFIRA I (A) (98-05)									
1.6 16V	Petrol	74	X 16 XEL;Z 16 XE		04/99-08/05		DSN3009	12	1.1
1.6 CNG	Petrol/ Compressed Natural Gas (CNG)	71	Z 16 YNG		09/01-06/05		DSN3009	12	1.1
1.6 Dualfuel	Petrol/ Liquefied Petroleum Gas (LPG)	74	X 16 XEL		11/98-08/05		DSN3009	12	1.1
2.0 DI 16V	Diesel	60	X 20 DTL		10/99-08/05		DSN3017	12	2
2.0 DTI 16V	Diesel	74	Y 20 DTH		04/99-08/05		DSN3017	12	2
ZAFIRA III (C) (11-18)									
2.0 CDTI	Diesel	125	B 20 DTH	MTM	01/15-08/18	+ SS	DSN1453	12	1.9
VOLVO									
C30 (06-12)									
1.6	Petrol	74	B 4164 S3		10/06-12/12		DSN3001	12	1.1
S40 II (04-12)									
1.6	Petrol	74	B 4164 S3		01/05-12/12		DSN3001	12	1.1
V50 (04-12)									
1.6	Petrol	74	B 4164 S3		01/05-12/12		DSN3001	12	1.1
1.8	Petrol	92	B 4184 S11	MTM	04/04-12/10		DSN3001	12	1.1
VW									
ARTEON (3H) (17-)									
2.0 TDI	Diesel	110/140	DBGA;DFGA;DFHA; DSRA;DSRB;DTSA; DTSB	ATM	03/17-06/20	BO;VA;+ SS	DSN1460	12	2.0











										
VW continued										
ARTEON (3H) (17-) continued										
2.0 TDI	Diesel	110/140	DBGA;DFGA;DFHA;DSRA;DSRB;DTSA;DTSB	MTM	03/17-06/20	BO;VA;+ SS	DSN1461	12	2.0	
2.0 TDI 4motion	Diesel	140/176	CUAA;DFHA	ATM	03/17-07/20	BO;VA;+ SS	DSN1460	12	2.0	
2.0 TSI	Petrol	140	CZPB;DKZA	ATM	05/17-	BO;+ SS	DSN1464	12	1.5	
2.0 TSI 4motion	Petrol	206	DJHC	ATM	04/17-06/20	BO;+ SS	DSN1464	12	1.5	
BEEBLE (5C) (11-19)										
1.2 TSI	Petrol	77	CBZB	MTM	07/11-07/19	+ SS	DSN964	12	2.0	
1.2 TSI	Petrol	77	CBZB	MTM	07/11-07/19	BO;+ SS	DSN1467	12	2.0	
1.2 TSI	Petrol	77	CBZB	ATM	12/13-07/19	BO;+ SS	DSN1465	12	1.5	
1.2 TSI 16V	Petrol	77	CYVD	ATM	12/14-07/19	BO;+ SS	DSN1465	12	1.5	
1.2 TSI 16V	Petrol	77	CYVD	MTM	12/14-07/19	BO;+ SS	DSN1467	12	2.0	
1.4 TSI	Petrol	110	CZDA	MTM	12/14-07/19	+ SS	DSN1466	12	1.5	
1.4 TSI	Petrol	110	CZDA	ATM	12/14-07/19	BO;+ SS	DSN1465	12	1.5	
1.6 TDI	Diesel	77	CAYC	MTM	10/11-07/16	BO;VA;- SS	DSN963	12	2.0	
1.6 TDI	Diesel	77	CAYC	ATM	10/11-07/16	BO;VA;+ SS	DSN1463	12	2.0	
1.6 TDI	Diesel	77	CAYC	MTM	10/11-07/16	BO;VA;+ SS	DSN1462	12	2.0	
2.0 TDI	Diesel	81	CUUA	ATM	07/16-09/18	BO;VA;+ SS	DSN1463	12	2.0	
2.0 TDI	Diesel	81	CUUA	MTM	07/16-09/18	BO;VA;+ SS	DSN1462	12	2.0	
2.0 TDI	Diesel	110	CUUB;DELA	ATM	07/16-09/18	BO;VA;+ SS	DSN1460	12	2.0	
2.0 TDI	Diesel	110	CUUB;DELA	MTM	07/16-09/18	BO;VA;+ SS	DSN1461	12	2.0	
2.0 TSI	Petrol	147	CCZA	MTM	04/11-07/16		DSN3005	12	1.1	
2.0 TSI	Petrol	162	CULC	ATM	12/14-09/18	BO;+ SS	DSN1464	12	1.5	
2.0 TSI	Petrol	162	CULC	MTM	12/14-09/18	BO;+ SS	DSN1468	12	1.5	
BORA (1J) (98-05)										
1.8 T	Petrol	110	AGU;AUM	ATM	05/00-05/05	HI	DSN957	12	1.4	
1.9 TDI	Diesel	74/85/96	AJM;ASZ;ATD;AUY	ATM	05/00-05/05	HI	DSN958	12	2.4	
1.9 TDI 4motion	Diesel	74/85/96	ASZ;ATD;AUY	ATM	05/00-05/05	HI	DSN958	12	2.4	
2.3 V5	Petrol	125	AQN	ATM	10/00-05/05	HI	DSN957	12	1.4	
2.3 V5 4motion	Petrol	125	AQN	ATM	10/00-05/05	HI	DSN957	12	1.4	
CADDY III (2K, 2C) (04-15)										
1.2 TSI	Petrol	63/77	CBZA;CBZB	MTM	09/10-05/15	+ SS	DSN964	12	2.0	
1.2 TSI	Petrol	63/77	CBZA;CBZB	MTM	09/10-05/15	BO;+ SS	DSN1467	12	2.0	
1.6 TDI	Diesel	55/75	CAYD;CAYE	MTM	08/10-05/15	BO;VA;- SS	DSN963	12	2.0	
1.6 TDI	Diesel	55/75	CAYD;CAYE	MTM	08/10-05/15	BO;VA;+ SS	DSN1462	12	2.0	
1.6 TDI	Diesel	75	CAYD	ATM	08/10-05/15	BO;VA;+ SS	DSN1463	12	2.0	
1.9 TDI	Diesel	55	BSU	MTM	09/05-08/10		DSN3007	12	1.7	
1.9 TDI	Diesel	77	BJB;BLS		04/04-08/10		DSN3007	12	1.7	
2.0 TDI	Diesel	62/103/125	CFHC;CFHE;CFJA;CLCB	MTM	11/10-05/15	BO;VA;+ SS	DSN1461	12	2.0	
2.0 TDI	Diesel	81	CLCA		08/10-05/15	BO;VA;- SS	DSN963	12	2.0	
2.0 TDI	Diesel	103/125	CFHC;CFJA	ATM	11/10-05/15	BO;VA;+ SS	DSN1460	12	2.0	
2.0 TDI 4motion	Diesel	62/103	CFHC;CFHE	MTM	11/10-05/15	BO;VA;+ SS	DSN1461	12	2.0	
2.0 TDI 4motion	Diesel	103	CFHC	ATM	11/10-05/15	BO;VA;+ SS	DSN1460	12	2.0	
CADDY IV (SA) (15-)										
1.0 TSI	Petrol	75	CHZG;DKRE	MTM	11/15-	+ SS	DSN1466	12	1.5	
1.2 TSI 16V	Petrol	62	CYVC	MTM	06/15-	BO;+ SS	DSN1467	12	2.0	
1.4 TGI CNG	Petrol/ Compressed Natural Gas (CNG)	81	CPWA	MTM	06/15-	+ SS	DSN1466	12	1.5	
1.4 TGI CNG	Petrol/ Compressed Natural Gas (CNG)	81	CPWA	ATM	06/15-	BO;+ SS	DSN1464	12	1.5	
1.4 TSI	Petrol	92	CZCB	MTM	05/15-	+ SS	DSN1466	12	1.5	
1.4 TSI	Petrol	92	CZCB	ATM	05/15-	BO;+ SS	DSN1465	12	1.5	
1.6 TDI	Diesel	55/75	CAYD;CAYE	MTM	05/15-	BO;VA;+ SS	DSN1462	12	2.0	
1.6 TDI	Diesel	75	CAYD	ATM	05/15-	BO;VA;+ SS	DSN1463	12	2.0	
2.0 TDI	Diesel	55/75	CUUD;CUUF;DFSC;DFSD;DFSF	5MTM	05/15-	BO;VA;+ SS	DSN1462	12	2.0	
2.0 TDI	Diesel	55/75/ 103/110	CFHC;CLCB;CUUB;DFSB;DFSC;DFSD	6MTM	05/15-	BO;VA;+ SS	DSN1461	12	2.0	
2.0 TDI	Diesel	75/103/ 110	CFHC;CUUB;CUUD;DFSB;DFSD	ATM	05/15-	BO;VA;+ SS	DSN1460	12	2.0	











Starters & Alternators

Application Tables - Starters

										
VW continued										
CADDY IV (SA) (15-) continued										
2.0 TDI 4motion	Diesel	55/81/90/103/110	CFHC;CFHF;CLCA;CUUE;DFSB;DFSC;DFSE	6MTM	05/15-		BO;VA;+ SS	DSN1461	12	2.0
2.0 TDI 4motion	Diesel	103/110	CFHC;DFSB	ATM	05/15-		BO;VA;+ SS	DSN1460	12	2.0
CC (358) (11-16)										
1.4 TSI	Petrol	110	CZDA	MTM	05/15-12/16		BO;+ SS	DSN1466	12	1.5
1.4 TSI	Petrol	110/118	CTHD;CZDA	ATM	11/11-12/16		BO;+ SS	DSN1465	12	1.5
1.8 TSI	Petrol	112/118	CDAA;CDAB	ATM	05/13-12/16		BO;+ SS	DSN1465	12	1.5
2.0 TDI	Diesel	100/103/110/125/130/135	CFFA;CFFB;CFGB;CFGC;CLLA;CUVC;CUWA	ATM	11/11-12/16		BO;VA;+ SS	DSN1460	12	2.0
2.0 TDI	Diesel	100/103/110/125/130/135	CFFA;CFFB;CFGB;CFGC;CLLA;CUVC;CUWA	MTM	11/11-12/16		BO;VA;+ SS	DSN1461	12	2.0
2.0 TDI 4motion	Diesel	103/125/130	CFFB;CFGB;CFGC	ATM	11/11-12/16		BO;VA;+ SS	DSN1460	12	2.0
2.0 TDI 4motion	Diesel	103/125/130	CFFB;CFGB;CFGC	MTM	11/11-12/16		BO;VA;+ SS	DSN1461	12	2.0
2.0 TSI	Petrol	147/155	CBFA;CCTA;CCZB	ATM	11/11-12/16		BO;+ SS	DSN1464	12	1.5
2.0 TSI	Petrol	155	CCZB	6MTM	11/11-12/16		BO;VA;- SS	DSN3005	12	1.1
CRAFTER (16-)										
2.0 TDI	Diesel	75/103/130	DAUA;DAUB;DAVA	Automatic Transmission, 8-speed	09/16-		BO;VA	DSN1461	12	2.0
2.0 TDI 4motion	Diesel	130	DAVA	Automatic Transmission, 8-speed	03/17-		BO;VA	DSN1461	12	2.0
EOS (1F) (06-15)										
2.0 TDI	Diesel	100/103	CFFA;CFFB	ATM	11/10-08/15		BO;VA;+ SS	DSN1460	12	2.0
2.0 TDI	Diesel	100/103	CFFA;CFFB	MTM	11/10-08/15		BO;VA;+ SS	DSN1461	12	2.0
2.0 TDI 8V	Diesel	103	BMM		06/06-05/08			DSN3008	12	1.7
2.0 TFSI	Petrol	147	BWA	MTM	03/06-08/15			DSN3005	12	1.1
2.0 TSI	Petrol	155	CCZB	6MTM	11/09-08/15		- SS	DSN3005	12	1.1
3.2 V6	Petrol	184	BUB		06/06-05/09			DSN3008	12	1.7
GOLF IV (1J, 1E) (97-06)										
1.8 T	Petrol	110	AUM	5ATM	09/00-06/06		HI	DSN957	12	1.4
1.9 TDI	Diesel	74/85/96	ASZ;ATD;AUY	ATM	01/00-06/06		HI	DSN958	12	2.4
1.9 TDI 4motion	Diesel	74/85/96	ASZ;ATD;AUY	ATM	01/00-06/06		HI	DSN958	12	2.4
2.3 V5	Petrol	125	AQN	ATM	10/00-06/06		HI	DSN957	12	1.4
2.3 V5 4motion	Petrol	125	AQN	ATM	10/00-06/06		HI	DSN957	12	1.4
2.8 VR6 4motion	Petrol	150	AUE;BDE	ATM	01/01-04/02		HI	DSN957	12	1.4
GOLF Plus (5M, 521) (05-14)										
1.2 TSI	Petrol	63/77	CBZA;CBZB	MTM	11/09-12/13		+ SS	DSN964	12	2.0
1.2 TSI	Petrol	63/77	CBZA;CBZB	MTM	11/09-12/13		BO;+ SS	DSN1467	12	2.0
1.2 TSI	Petrol	63/77	CBZA;CBZB	ATM	02/13-12/13		BO;+ SS	DSN1465	12	1.5
1.4 16V	Petrol	55/59	BCA;BUD	MTM	01/05-12/13			DSN3006	12	1
1.4 FSI	Petrol	66	BLN	MTM	07/05-11/06			DSN3006	12	1
1.4 TSI	Petrol	90	CAXA	ATM	02/13-12/13		BO;+ SS	DSN1465	12	1.5
1.6	Petrol	75	BSE;BSF;CCSA	ATM	05/05-12/13			DSN3005	12	1.1
1.6 FSI	Petrol	85	BLF	ATM	12/04-05/08			DSN3005	12	1.1
1.6 TDI	Diesel	66/77	CAYB;CAYC	MTM	02/09-12/13		BO;VA;- SS	DSN963	12	2.0
1.6 TDI	Diesel	66/77	CAYB;CAYC	MTM	02/09-12/13		BO;VA;+ SS	DSN1462	12	2.0
1.6 TDI	Diesel	77	CAYC	ATM	03/09-12/13		BO;VA;+ SS	DSN1463	12	2.0
1.9 TDI	Diesel	66	BRU;BXF	MTM	05/05-12/08			DSN3007	12	1.7
1.9 TDI	Diesel	77	BKC;BLS;BXE		01/05-01/09			DSN3007	12	1.7
2.0 FSI	Petrol	110	BLR;BLY;BVY;BVZ	MTM	05/05-06/08			DSN3005	12	1.1
2.0 TDI	Diesel	81	CBDC;CLCA	MTM	01/09-12/13		BO;VA;- SS	DSN963	12	2.0
2.0 TDI	Diesel	100	AZV		05/05-12/13		BO;VA;- SS	DSN3008	12	1.7
2.0 TDI	Diesel	100/103	CFHB;CFHC	MTM	01/05-12/13		BO;VA;+ SS	DSN1461	12	2.0
2.0 TDI	Diesel	103	BKD		01/05-12/13		BO;VA	DSN3008	12	1.7
2.0 TDI	Diesel	103	CFHC	ATM	01/05-12/13		BO;VA;+ SS	DSN1460	12	2.0
2.0 TDI 8V	Diesel	103	BMM		12/05-05/11			DSN3008	12	1.7
GOLF Sportsvan (AM1) (14-)										
1.0 TSI	Petrol	63/81/85	CHZC;CHZD;CHZK;DKLB;DKRF	MTM	05/15-		+ SS	DSN1466	12	1.5











										
VW continued										
GOLF Sportsvan (AM1) (14-) continued										
1.0 TSI	Petrol	63/81/85	CHZC;CHZD;CHZK;DKLB;DKRF	ATM	05/15-			BO;+ SS	DSN1465	12 1.5
1.2 TSI 16V	Petrol	63/81	CYVA;CYVB	MTM	04/14-11/17			BO;+ SS	DSN1468	12 1.5
1.2 TSI 16V	Petrol	63/81	CYVA;CYVB	MTM	04/14-11/17			BO;+ SS	DSN1467	12 2.0
1.4 TSI	Petrol	92/110	CZCA;CZDA	MTM	02/14-			+ SS	DSN1466	12 1.5
1.4 TSI	Petrol	92/110	CZCA;CZDA	ATM	02/14-			BO;+ SS	DSN1465	12 1.5
1.4 TSI MultiFuel	Flexfuel	92	CPVB	MTM	04/14-			+ SS	DSN1466	12 1.5
1.4 TSI MultiFuel	Flexfuel	92	CPVB	ATM	04/14-			BO;+ SS	DSN1465	12 1.5
1.5 TSI	Petrol	96/110	DACA;DADA;DPCA	ATM	05/17-			BO;+ SS	DSN1465	12 1.5
1.5 TSI	Petrol	96/110	DACA;DADA;DPCA	MTM	05/17-			BO;+ SS	DSN1468	12 1.5
1.6 TDI	Diesel	66/81/85	CRKA;CRKB;CXXA;CXXB;DBKA;DDYA;DDYB;DGTE	ATM	02/14-			BO;VA;+ SS	DSN1463	12 2.0
1.6 TDI	Diesel	66/81/85	CRKA;CRKB;CXXA;CXXB;DBKA;DDYA;DDYB;DGTE	MTM	02/14-			BO;VA;+ SS	DSN1462	12 2.0
2.0 TDI	Diesel	81/110	CRLB;CRLD;CRVA;DCYA;DCYB;DFGA	ATM	02/14-			BO;VA;+ SS	DSN1460	12 2.0
2.0 TDI	Diesel	81/110	CRLB;CRLD;CRVA;DCYA;DCYB;DFGA	MTM	02/14-			BO;VA;+ SS	DSN1461	12 2.0
GOLF V (1K) (03-09)										
1.4	Petrol	59	BUD	MTM	06/07-07/09				DSN3006	12 1
1.4 16V	Petrol	55/59	BCA;BUD	MTM	10/03-11/08				DSN3006	12 1
1.4 FSI	Petrol	66	BLN	MTM	10/03-07/06				DSN3006	12 1
1.6	Petrol	75	BGU;BSE;BSF;CCSA		01/04-07/09				DSN3005	12 1.1
1.6 FSI	Petrol	85	BAG;BLF;BLP		10/03-07/08				DSN3006	12 1
1.9 TDI	Diesel	66	BRU;BXF	MTM	05/04-11/08				DSN3007	12 1.7
1.9 TDI	Diesel	77	BKC;BLS;BXE		10/03-07/09				DSN3007	12 1.7
1.9 TDI 4motion	Diesel	77	BKC;BLS;BXE		08/04-07/09				DSN3007	12 1.7
2.0	Petrol	85	BEV;BHY	ATM	01/05-11/08				DSN3005	12 1.1
2.0	Petrol	147	BWA	MTM	06/07-07/09				DSN3005	12 1.1
2.0 FSI	Petrol	110	BVY;BVZ		01/04-11/08				DSN3005	12 1.1
2.0 GTI	Petrol	147	BWA	MTM	10/04-02/09				DSN3005	12 1.1
2.0 GTI	Petrol	169	BYD	ATM	09/06-12/08				DSN3005	12 1.1
2.0 TDI	Diesel	100/103/125	AZV;BKD;BMN		10/03-11/08				DSN3008	12 1.7
2.0 TDI 4motion	Diesel	103	BKD		08/04-11/08				DSN3008	12 1.7
2.0 TDI 8V	Diesel	103	BMM		12/04-07/09				DSN3008	12 1.7
2.0 TDI 8V 4motion	Diesel	103	BMM		01/07-11/08				DSN3008	12 1.7
3.2 R32 4motion	Petrol	184	BUB		11/05-11/08				DSN3008	12 1.7
GOLF VI (5K, AJ5) (08-14)										
1.2 TSI	Petrol	63/77	CBZA;CBZB	MTM	11/08-07/13			+ SS	DSN964	12 2.0
1.2 TSI	Petrol	63/77	CBZA;CBZB	MTM	11/08-07/13			BO;+ SS	DSN1467	12 2.0
1.4	Petrol	59	BUD;CGGA	MTM	10/08-07/13				DSN3006	12 1
1.6	Petrol	75	BSE;BSF;CCSA	ATM	07/09-07/13				DSN3005	12 1.1
1.6 BiFuel	Petrol/ Liquified Petroleum Gas (LPG)	75	BSF		07/09-12/10				DSN3005	12 1.1
1.6 TDI	Diesel	66/77	CAYB;CAYC	MTM	02/09-07/13			BO;VA;- SS	DSN963	12 2.0
1.6 TDI	Diesel	66/77	CAYB;CAYC	MTM	02/09-07/13			BO;VA;+ SS	DSN1462	12 2.0
1.6 TDI	Diesel	77	CAYC	ATM	02/09-11/12			BO;VA;+ SS	DSN1463	12 2.0
1.6 TDI 4motion	Diesel	77	CAYC	MTM	07/09-07/13			BO;VA;- SS	DSN963	12 2.0
1.6 TDI 4motion	Diesel	77	CAYC	MTM	07/09-07/13			BO;VA;+ SS	DSN1462	12 2.0
2.0 GTi	Petrol	147	CCZA	MTM	06/09-11/13				DSN3005	12 1.1
2.0 GTi	Petrol	155	CCZB	6MTM	02/09-11/12			- SS	DSN3005	12 1.1
2.0 GTi	Petrol	173	CDLG	MTM	05/11-11/12			- SS	DSN3005	12 1.1
2.0 R 4motion	Petrol	188	CDLC		11/09-11/13				DSN3005	12 1.1
2.0 R 4motion	Petrol	199	CDLF	MTM	11/09-11/12				DSN3005	12 1.1
2.0 TDI	Diesel	81	CBDC;CLCA	MTM	10/08-11/12			BO;VA;- SS	DSN963	12 2.0
2.0 TDI	Diesel	81	CLCA	5MTM	01/10-07/13			MY: 2010>	DSN963	12 2.0
2.0 TDI	Diesel	81/100/103/125	CBAA;CBAB;CBBB;CBDC;CFFA;CFFB;CFGB;CJAA	MTM	10/08-05/13			BO;VA;+ SS	DSN1461	12 2.0
2.0 TDI	Diesel	81/103/125	CBAB;CBBB;CBDC;CFFB;CFGB;CJAA	ATM	10/08-05/13			BO;VA;+ SS	DSN1460	12 2.0
2.0 TDI 4motion	Diesel	103	CBAB;CFFB	ATM	05/09-11/12			BO;VA;+ SS	DSN1460	12 2.0
2.0 TDI 4motion	Diesel	103	CBAB;CFFB	MTM	05/09-11/12			BO;VA;+ SS	DSN1461	12 2.0
2.0 TSI	Petrol	147	CCZA		07/09-07/13				DSN3005	12 1.1











									
VW continued									
GOLF VI (5K, AJ5) (08-14) continued									
2.0 TSI R 4motion	Petrol	199	CDLF	MTM	11/09-11/12		DSN3005	12	1.1
GOLF VI Convertible (517) (11-16)									
1.2 TSI	Petrol	77	CBZB	MTM	03/11-05/16	+ SS	DSN964	12	2.0
1.2 TSI	Petrol	77	CBZB	MTM	03/11-05/16	BO;+ SS	DSN1467	12	2.0
1.2 TSI 16V	Petrol	77	CJZA;CYVD	MTM	11/13-05/16	BO;+ SS	DSN1467	12	2.0
1.4 TSI	Petrol	92	CZCA	MTM	11/13-05/16	+ SS	DSN1466	12	1.5
1.4 TSI	Petrol	92	CZCA	ATM	11/13-05/16	BO;+ SS	DSN1465	12	1.5
1.6 TDI	Diesel	77	CAYC	MTM	03/11-05/16	BO;VA;- SS	DSN963	12	2.0
1.6 TDI	Diesel	77	CAYC	MTM	03/11-05/16	BO;VA;+ SS	DSN1462	12	2.0
2.0 GTI	Petrol	155	CCZB	6MTM	05/12-05/16	- SS	DSN3005	12	1.1
2.0 TDI	Diesel	81	CUUA	5MTM	11/13-05/16	BO;VA;+ SS	DSN1462	12	2.0
2.0 TDI	Diesel	103/110	CFHC;CUUB	6MTM	11/11-05/16	BO;VA;+ SS	DSN1461	12	2.0
2.0 TDI	Diesel	103/110	CFHC;CUUB	ATM	11/11-05/16	BO;VA;+ SS	DSN1460	12	2.0
2.0 TSI	Petrol	162	CULC	ATM	11/13-05/16	BO;+ SS	DSN1464	12	1.5
GOLF VII (5G, BA5) (12-)									
1.0 TSI	Petrol	63/81/85	CHZC;CHZD;CHZK;DKLB;DKRF	MTM	05/15-	+ SS	DSN1466	12	1.5
1.0 TSI	Petrol	63/81/85	CHZC;CHZD;CHZK;DKLB;DKRF	ATM	05/15-	BO;+ SS	DSN1465	12	1.5
1.2 TSI 16V	Petrol	63	CJZB;CYVA	MTM	11/13-	BO;+ SS	DSN1468	12	1.5
1.2 TSI 16V	Petrol	63/77/81	CJZA;CJZB;CYVA;CYVB	MTM	08/12-	BO;+ SS	DSN1467	12	2.0
1.2 TSI 16V	Petrol	77/81	CJZA;CYVB	ATM	11/12-	BO;+ SS	DSN1465	12	1.5
1.4 TGI CNG	Petrol/ Compressed Natural Gas (CNG)	81	CPWA;CZBA	MTM	06/13-	+ SS	DSN1466	12	1.5
1.4 TGI CNG	Petrol/ Compressed Natural Gas (CNG)	81	CPWA;CZBA	ATM	06/13-	BO;+ SS	DSN1465	12	1.5
1.4 TSI	Petrol	90/92/ 103/110	CHPA;CHPB;CMBA;CPTA;CXSA;CZCA;CZDA;CZDD;CZEA;DGXA	MTM	08/12-	+ SS	DSN1466	12	1.5
1.4 TSI	Petrol	90/92/ 103/110	CHPA;CHPB;CMBA;CPTA;CXSA;CZCA;CZDA;CZDD;CZEA;DGXA	ATM	08/12-	BO;+ SS	DSN1465	12	1.5
1.4 TSI MultiFuel	Flexfuel	90/92	CPVA;CPVB	MTM	04/13-	+ SS	DSN1466	12	1.5
1.5 TSI	Petrol	96/110	DACA;DADA;DPBA;DPCA	ATM	04/17-	BO;+ SS	DSN1465	12	1.5
1.5 TSI	Petrol	96/110	DACA;DADA;DPBA;DPCA	MTM	04/17-	BO;+ SS	DSN1468	12	1.5
1.6	Petrol	81	CWVA	MTM; ATM	05/14-	BO;- SS;+ Co	DSN1468	12	1.5
1.6 TDI	Diesel	66/77/ 81/85	CLHA;CLHB;CRKA;CRKB;CXXA;CXXB;DBKA;DDYA;DDYB;DGTE	MTM	08/12-	BO;VA;+ SS	DSN1462	12	2.0
1.6 TDI	Diesel	66/77/ 81/85	CLHA;CRKB;CXXB;DBKA;DDYA;DDYB;DGTE	ATM	08/12-	BO;VA;+ SS	DSN1463	12	2.0
1.6 TDI 4motion	Diesel	77/81	CLHA;CRKB;CXXB	MTM	11/12-	BO;VA;+ SS	DSN1461	12	2.0
1.8 TSI 4motion	Petrol	132	CJSB	MTM	12/14-	+ SS	DSN1466	12	1.5
1.8 TSI 4motion	Petrol	132	CJSB	ATM	12/14-	BO;+ SS	DSN1464	12	1.5
2.0 GTD	Diesel	135	CUNA;DGCA;DJGA	ATM	04/13-	BO;VA;+ SS	DSN1460	12	2.0
2.0 GTD	Diesel	135	CUNA;DGCA;DJGA	MTM	04/13-	BO;VA;+ SS	DSN1461	12	2.0
2.0 GTI	Petrol	155/162/ 169/180	CHHA;CHHB;CNTA;CNTC;CXCA;CXCB;CXDA;CXDB;DKTB;DLBA	MTM	04/13-	BO;+ SS	DSN1468	12	1.5
2.0 GTI	Petrol	162/169/ 180	CHHA;CHHB;CXDA;CXDB;DKTB;DLBA	ATM	04/13-	BO;+ SS	DSN1464	12	1.5
2.0 GTI Clubsport	Petrol	195	CJXE	ATM	02/16-03/17	BO;+ SS	DSN1464	12	1.5
2.0 GTI Clubsport	Petrol	195	CJXE	MTM	02/16-03/17	BO;+ SS	DSN1468	12	1.5
2.0 GTI Clubsport S	Petrol	228	CJXG	ATM	09/16-	BO;+ SS	DSN1464	12	1.5
2.0 GTI Clubsport S	Petrol	228	CJXG	MTM	09/16-	BO;+ SS	DSN1468	12	1.5
2.0 R 360S 4motion	Petrol	265	CJXC	ATM	09/16-	BO;+ SS	DSN1464	12	1.5
2.0 R 360S 4motion	Petrol	265	CJXC	MTM	09/16-	BO;+ SS	DSN1468	12	1.5

										
VW continued										
GOLF VII (5G, BA5) (12-) continued										
2.0 R 4motion	Petrol	206/213/221/228	CJXB;CJXC;CJXD;CJXG;DJHA;DJHB;DNUC;DNUJ	ATM	11/13-			BO;+ SS	DSN1464	12 1.5
2.0 R 4motion	Petrol	206/213/221/228	CJXB;CJXC;CJXD;CJXG;DJHA;DJHB;DNUC;DNUJ	MTM	11/13-			BO;+ SS	DSN1468	12 1.5
2.0 TDI	Diesel	81/105/110	CRBB;CRBC;CRLB;CRLD;CRMB;CRUA;CRVA;CRVC;CYKB;DCYA;DCYB;DEJA;DEJB;DFGA;DFGB	ATM	08/12-			BO;VA;+ SS	DSN1460	12 2.0
2.0 TDI	Diesel	81/105/110	CRBB;CRBC;CRLB;CRLD;CRMB;CRUA;CRVA;CRVC;CYKB;DCYA;DCYB;DEJA;DEJB;DFGA;DFGB	MTM	08/12-			BO;VA;+ SS	DSN1461	12 2.0
2.0 TDI 4motion	Diesel	110/135	CKFC;CRBC;CRLB;CRMB;CUNA;DCYA;DGCA;DJGA	ATM	11/12-			BO;VA;+ SS	DSN1460	12 2.0
2.0 TDI 4motion	Diesel	110/135	CKFC;CRBC;CRLB;CRMB;CUNA;DCYA;DGCA;DJGA	MTM	11/12-			BO;VA;+ SS	DSN1461	12 2.0
JETTA III (1K2) (05-10)										
1.4 TSI	Petrol	90	CAXA		05/07-10/10				DSN3005	12 1.1
1.6	Petrol	75	BGU;BSE;BSF;CCSA		09/04-10/10				DSN3005	12 1.1
1.6 FSI	Petrol	85	BLF	ATM	09/05-10/10				DSN3005	12 1.1
1.6 TDI	Diesel	77	CAYC	MTM	06/09-10/10			BO;VA	DSN963	12 2.0
1.9 TDI	Diesel	77	BKC;BLS;BXE		08/05-10/10				DSN3007	12 1.7
2.0 FSI	Petrol	110	BVY;BVZ		08/05-10/10				DSN3005	12 1.1
2.0 TDI	Diesel	100/103	AZV;BKD		08/05-10/10				DSN3008	12 1.7
2.0 TDI 8V	Diesel	103	BMM		10/05-10/10				DSN3008	12 1.7
2.0 TFSI	Petrol	147	AXX;BPY;BWA		10/05-10/10				DSN3005	12 1.1
2.5	Petrol	125	CCCA	ATM	07/08-10/10				DSN3005	12 1.1
JETTA IV (162) (10-)										
1.2 TSI	Petrol	77	CBZB	MTM	10/10-			+ SS	DSN964	12 2.0
1.2 TSI	Petrol	77	CBZB	MTM	10/10-			BO;+ SS	DSN1467	12 2.0
1.2 TSI	Petrol	77	CBZB	ATM	08/14-			BO;+ SS	DSN1465	12 1.5
1.2 TSI 16V	Petrol	77	CYVD	ATM	08/14-			BO;+ SS	DSN1465	12 1.5
1.2 TSI 16V	Petrol	77	CYVD	MTM	08/14-			BO;+ SS	DSN1468	12 1.5
1.2 TSI 16V	Petrol	77	CYVD	MTM	08/14-			BO;+ SS	DSN1467	12 2.0
1.4 TSI	Petrol	92/110	CZCA;CZDA;CZTA	MTM	08/14-			+ SS	DSN1466	12 1.5
1.4 TSI	Petrol	92/110	CZCA;CZDA;CZTA	ATM	08/14-			BO;+ SS	DSN1465	12 1.5
1.6	Petrol	63	CFNB		03/13-				DSN3006	12 1
1.6	Petrol	77	CLRA		12/11-			- SS	DSN3005	12 1.1
1.6 TDI	Diesel	77	CAYC	MTM	04/10-07/15			BO;VA;- SS	DSN963	12 2.0
1.6 TDI	Diesel	77	CAYC	ATM	04/10-07/15			BO;VA;+ SS	DSN1463	12 2.0
1.6 TDI	Diesel	77	CAYC	MTM	04/10-07/15			BO;VA;+ SS	DSN1462	12 2.0
2.0	Petrol	85	CBPA;CKJA		06/10-12/17			- SS	DSN3005	12 1.1
2.0 TDI	Diesel	81/103	CLCA;CLCB;CUUA	MTM	10/10-			BO;VA;- SS	DSN963	12 2.0
2.0 TDI	Diesel	110	CUUB;CVCA;DELA;DGMA	6ATM	07/14-			BO;VA;+ SS	DSN1460	12 2.0
2.0 TDI	Diesel	110	CUUB;CVCA;DELA;DGMA	6MTM	07/14-			BO;VA;+ SS	DSN1461	12 2.0
2.0 TDI	Diesel	110	CUUB;DELA	5MTM	07/14-			BO;VA;+ SS	DSN1462	12 2.0
2.0 TDI	Diesel	110	CUUB;DELA	Automatic Transmission, 7-speed	07/14-			BO;VA;+ SS	DSN1463	12 2.0
2.0 TSI	Petrol	147	CCZA	MTM	12/10-				DSN3005	12 1.1
MULTIVAN V (7H, 7E) (03-15)										
1.9 TDI	Diesel	63	BRR		01/06-11/09			Ch No: WV1ZZZ7H27-000001 >>>	DSN3007	12 1.7
1.9 TDI	Diesel	63/75/77	AXB;AXC;BRS		04/03-11/09				DSN3007	12 1.7
2.0 BiTDI	Diesel	132	CFCA	6MTM	05/11-08/15			BO;VA;+ SS	DSN1461	12 2.0
2.0 BiTDI	Diesel	132	CFCA	ATM	05/11-08/15			BO;VA;+ SS	DSN1460	12 2.0
2.0 BiTDI 4motion	Diesel	132	CFCA	ATM	09/09-08/15			BO;VA;+ SS	DSN1460	12 2.0
2.0 TDI	Diesel	62/75	CAAA;CAAB	5MTM	09/09-08/15			BO;VA;- SS	DSN963	12 2.0
2.0 TDI	Diesel	62/75/84	CAAA;CAAB;CAAD	5MTM	05/11-08/15			BO;VA;+ SS	DSN1462	12 2.0
2.0 TDI	Diesel	100	CCHB		05/10-08/15				DSN1464	12 1.5
2.0 TDI	Diesel	103	CAAC;CCHA	6MTM	05/11-08/15			BO;VA;+ SS	DSN1461	12 2.0
2.0 TDI	Diesel	103	CAAC;CCHA	ATM	05/11-08/15			BO;VA;+ SS	DSN1460	12 2.0

Starters & Alternators











Application Tables - Starters











									
VW continued									
MULTIVAN V (7H, 7E) (03-15) continued									
2.0 TDI 4motion	Diesel	103	CAAC;CCHA	5MTM	09/09-08/15		DSN3007	12	1.7
2.0 TSI	Petrol	150	CJKA		05/11-08/15	- SS	DSN1464	12	1.5
MULTIVAN VI (SG) (15-)									
2.0 TDI	Diesel	75/84	CAAB;CXGB;CXHB	5MTM	04/15-	BO;VA;+ SS	DSN1462	12	2.0
2.0 TDI	Diesel	103/110/ 132/150	CAAC;CFCA;CXEB; CXFA;CXHA	ATM	04/15-	BO;VA;+ SS	DSN1460	12	2.0
2.0 TDI	Diesel	103/132	CAAC;CFCA	6MTM	04/15-	BO;VA;+ SS	DSN1461	12	2.0
2.0 TDI 4motion	Diesel	103/110/ 132/150	CAAC;CFCA;CXEB; CXFA;CXHA	ATM	06/15-	BO;VA;+ SS	DSN1460	12	2.0
2.0 TDI 4motion	Diesel	103/132	CAAC;CFCA	6MTM	06/15-	BO;VA;+ SS	DSN1461	12	2.0
2.0 TSI	Petrol	110	CJKB	MTM	04/15-	BO;+ SS	DSN1468	12	1.5
2.0 TSI	Petrol	150	CJKA	ATM	04/15-	BO;+ SS	DSN1464	12	1.5
2.0 TSI 4motion	Petrol	150	CJKA	ATM	06/15-	BO;+ SS	DSN1464	12	1.5
NEW BEETLE (9C, 1C, 1Y) (98-10)									
1.9 TDI	Diesel	74	ATD;AXR;BEW		02/01-09/10		DSN3008	12	1.7
PASSAT (3B2, 3B5) (96-01)									
1.9 TDI	Diesel	66/74/ 81/85	AFN;AHH;AHU;AJM; AVB		10/96-11/00		DSN3015	12	1.8
1.9 TDI	Diesel	85	AJM	ATM	08/98-11/00		DSN3015	12	1.8
1.9 TDI 4motion	Diesel	85	AJM;ATJ		08/99-11/00		DSN3015	12	1.8
1.9 TDI Syncro/4motion	Diesel	81	AFN		06/97-08/00		DSN3015	12	1.8
PASSAT (3B3, 3B6) (00-05)									
1.9 TDI	Diesel	74/96	AVB;AVF		11/00-05/05		DSN3015	12	1.8
1.9 TDI 4motion	Diesel	96	AVF		11/00-05/05		DSN3015	12	1.8
PASSAT (3C) (05-11)									
1.6 FSI	Petrol	85	BLF	ATM	03/05-06/08		DSN3005	12	1.1
1.6 TDI	Diesel	77	CAYC	5MTM	08/09-11/10	BO;VA;+ SS	DSN1462	12	2.0
1.9 TDI	Diesel	77	BKC;BLS;BXE		03/05-11/10		DSN3007	12	1.7
2.0 BlueTDI	Diesel	105	CBAC	6MTM	01/09-11/10	BO;VA;+ SS	DSN1461	12	2.0
2.0 FSI	Petrol	110	BLR;BLY;BVY;BVZ	MTM	03/05-07/10		DSN3005	12	1.1
2.0 FSI	Petrol	110/125	BLR;BLY;BVY;BVZ; CCTB		08/05-11/10		DSN3005	12	1.1
2.0 TDI	Diesel	81	CBDC		11/08-11/10	BO;VA;- SS	DSN963	12	2.0
2.0 TDI	Diesel	88/90/ 100/120	BMA;BUZ;BVE;BWV		03/05-11/10		DSN3008	12	1.7
2.0 TDI	Diesel	103	BKP	6MTM	05/08-07/10	BO;VA	DSN3008	12	1.7
2.0 TDI	Diesel	103/125	BKP;BMR		05/08-11/10	BO;VA;- SS	DSN3008	12	1.7
2.0 TDI	Diesel	103/125	BKP;CBAB;CBBB	6MTM	05/08-11/10	BO;VA;+ SS	DSN1461	12	2.0
2.0 TDI	Diesel	125	BMR		05/08-07/10	BO;VA	DSN3008	12	1.7
2.0 TDI 4motion	Diesel	103	BKP		03/05-08/10		DSN3008	12	1.7
2.0 TDI 4motion	Diesel	103	CBAB		08/05-11/10	- SS	DSN1461	12	2.0
2.0 TDI 8V	Diesel	103	BMP	ATM	03/05-05/09		DSN3008	12	1.7
2.0 TDI 8V 4motion	Diesel	103	BMP	ATM	03/05-05/09		DSN3008	12	1.7
2.0 TSI	Petrol	147	AXX;BPY;BWA		07/05-07/10		DSN3005	12	1.1
3.2 FSI 4motion	Petrol	184	AXZ		11/05-11/10		DSN3008	12	1.7
3.6 R36 4motion	Petrol	220	BWS		04/07-11/10		DSN3008	12	1.7
PASSAT (3G) (14-)									
1.4 TSI	Petrol	92/110	CZCA;CZDA;CZEA	MTM	11/14-	+ SS	DSN1466	12	1.5
1.4 TSI	Petrol	92/110	CZCA;CZDA;CZEA	ATM	11/14-	BO;+ SS	DSN1465	12	1.5
1.4 TSI 4motion	Petrol	110	CZEA	ATM	02/15-	BO;+ SS	DSN1464	12	1.5
1.4 TSI 4motion	Petrol	110	CZEA	MTM	02/15-	BO;+ SS	DSN1468	12	1.5
1.6 TDI	Diesel	88	DCXA;DCZA	ATM	08/14-	BO;VA;+ SS	DSN1463	12	2.0
1.6 TDI	Diesel	88	DCXA;DCZA	MTM	08/14-	BO;VA;+ SS	DSN1462	12	2.0
1.8 TSI	Petrol	132	CJSA;CJSC	ATM	02/15-	BO;+ SS	DSN1465	12	1.5
1.8 TSI	Petrol	132	CJSA;CJSC	MTM	02/15-	BO;+ SS	DSN1468	12	1.5
2.0 TDI	Diesel	110/135/ 140	CRLB;CUPA;DBGA; DDAA;DFCA;DFGA; DFHA;DSRA;DSRB	ATM	11/14-	BO;VA;+ SS	DSN1460	12	2.0
2.0 TDI	Diesel	110/135/ 140	CRLB;CUPA;DBGA; DDAA;DFCA;DFGA; DFHA;DSRA;DSRB	MTM	11/14-	BO;VA;+ SS	DSN1461	12	2.0
2.0 TDI 4motion	Diesel	110/135/ 140/176	CRLB;CUAA;CUPA; DDAA;DFCA;DFEA; DFGA;DFHA	ATM	08/14-	BO;VA;+ SS	DSN1460	12	2.0
2.0 TDI 4motion	Diesel	110/135/ 140/176	CRLB;CUAA;CUPA; DDAA;DFCA;DFEA; DFGA;DFHA	MTM	08/14-	BO;VA;+ SS	DSN1461	12	2.0
2.0 TSI	Petrol	162	CHHB;CXDA	ATM	08/14-	BO;+ SS	DSN1464	12	1.5
2.0 TSI 4motion	Petrol	162/206	CHHB;CJXA	ATM	05/15-	BO;+ SS	DSN1464	12	1.5
PASSAT (362, 365) (10-14)									
1.4 TSI	Petrol	90/118	CAXA;CTHD	ATM	11/12-12/14	BO;+ SS	DSN1465	12	1.5











									
VW continued									
PASSAT (362, 365) (10-14) continued									
1.4 TSI EcoFuel	Petrol/ Compressed Natural Gas (CNG)	110	CDGA	ATM	05/13-12/14	BO;+ SS	DSN1465	12	1.5
1.4 TSI MultiFuel	Flexfuel	118	CKMA	ATM	05/13-12/14	BO;+ SS	DSN1465	12	1.5
1.6 TDI	Diesel	77	CAYC	ATM	08/10-12/14	BO;VA;+ SS	DSN1463	12	2.0
1.6 TDI	Diesel	77	CAYC	MTM	08/10-12/14	BO;VA;+ SS	DSN1462	12	2.0
1.8 TSI	Petrol	112	CDAB	ATM	05/13-12/14	BO;VA;- SS	DSN3005	12	1.1
1.8 TSI	Petrol	112/118	CDA;CDAB	ATM	05/13-12/14	BO;+ SS	DSN1465	12	1.5
2.0 TDI	Diesel	100/103/ 125/130	CFFA;CFFB;CFGB; CFGC;CLLA	MTM	08/10-12/14	BO;VA;+ SS	DSN1461	12	2.0
2.0 TDI	Diesel	103/125/ 130	CFFB;CFGB;CFGC;	ATM	08/10-12/14	BO;VA;+ SS	DSN1460	12	2.0
2.0 TDI 4motion	Diesel	103/125/ 130	CFFB;CFGB;CFGC	ATM	08/10-12/14	BO;VA;+ SS	DSN1460	12	2.0
2.0 TDI 4motion	Diesel	103/125/ 130	CFFB;CFGB;CFGC	MTM	08/10-12/14	BO;VA;+ SS	DSN1461	12	2.0
2.0 TSI	Petrol	155	CCZB	6MTM	11/10-08/12	- SS	DSN3005	12	1.1
2.0 TSI	Petrol	155	CCZB	MTM	11/10-08/12	- SS	DSN3005	12	1.1
2.0 TSI	Petrol	155	CCZB	MTM	11/10-08/12	+ SS	DSN962	12	2.0
2.0 TSI	Petrol	155	CCZB	6MTM	08/12-12/14	BO;VA;- SS	DSN3005	12	1.1
2.0 TSI	Petrol	155	CCZB	MTM	08/12-12/15	BO;+ SS	DSN1468	12	1.5
2.0 TSI 4motion	Petrol	155	CCZB	6MTM	01/12-08/12	- SS	DSN3005	12	1.1
2.0 TSI 4motion	Petrol	155	CCZB	MTM	01/12-08/12	+ SS	DSN962	12	2.0
2.0 TSI 4motion	Petrol	155	CCZB	MTM	08/12-12/14	BO;+ SS	DSN1468	12	1.5
PASSAT CC (357) (08-12)									
2.0 BlueTDI	Diesel	105	CBAC	MTM	11/09-11/10	BO;VA;+ SS	DSN1461	12	2.0
2.0 TDI	Diesel	100/103/ 125	CBAA;CBAB;CBBB; CFFA;CFFB;CFGB	MTM	11/09-01/12	BO;VA;+ SS	DSN1461	12	2.0
2.0 TDI	Diesel	100/103/ 125	CFFA;CFFB;CFGB	ATM	11/09-01/12	BO;VA;+ SS	DSN1460	12	2.0
2.0 TDI 4motion	Diesel	125	CBBB	5MTM	11/09-01/12	+ SS	DSN1461	12	2.0
2.0 TSI	Petrol	147	CCZA	MTM	06/08-01/12		DSN3005	12	1.1
2.0 TSI	Petrol	155	CCZB	MTM	11/10-01/12	- SS	DSN3005	12	1.1
3.6 FSI 4motion	Petrol	220	BWS		02/08-12/11		DSN3008	12	1.7
POLO (6R, 6C) (09-)									
1.0	Petrol	44/55	CHYA;CHYB	MTM	01/14-10/17	BO;+ SS	DSN1468	12	1.5
1.0 TSI	Petrol	70/81	CHZB;CHZC	ATM	11/14-10/17	BO;+ SS	DSN1465	12	1.5
1.0 TSI	Petrol	70/81	CHZB;CHZC	MTM	11/14-10/17	BO;+ SS	DSN1468	12	1.5
1.2	Petrol	51	CGPA		03/09-	- SS	DSN3006	12	1
1.2 TDI	Diesel	55	CFWA	MTM	10/09-	BO;VA;- SS	DSN963	12	2.0
1.2 TDI	Diesel	55	CFWA	MTM	10/09-	BO;VA;+ SS	DSN1462	12	2.0
1.2 TSI	Petrol	66	CBZC		05/11-05/14	- SS	DSN3006	12	1
1.2 TSI	Petrol	66	CBZC		03/13-05/14	BO;VA;- SS	DSN3006	12	1
1.2 TSI	Petrol	66/77	CBZB;CBZC	ATM	03/13-05/14	BO;+ SS	DSN1465	12	1.5
1.2 TSI 16V	Petrol	66/81	CJZC;CJZD	MTM	01/14-10/17	+ SS	DSN962	12	2.0
1.2 TSI 16V	Petrol	66/81	CJZC;CJZD	ATM	01/14-10/17	BO;+ SS	DSN1465	12	1.5
1.2 TSI 16V	Petrol	66/81	CJZC;CJZD	MTM	01/14-10/17	BO;+ SS	DSN1468	12	1.5
1.4 BiFuel	Petrol/ Liquified Petroleum Gas (LPG)	60	CMAA		03/10-01/11	- SS	DSN3006	12	1
1.4 TDI	Diesel	55/66/77	CUSA;CUSB;CUTA; CYZA;CYZB	MTM	02/14-	BO;VA;+ SS	DSN1462	12	2.0
1.4 TDI	Diesel	66	CUSB	ATM	02/14-	BO;VA;+ SS	DSN1463	12	2.0
1.4 TSI	Petrol	103	CPTA	MTM	10/12-05/13	+ SS	DSN962	12	2.0
1.4 TSI	Petrol	103/110	CPTA;CZEA	ATM	10/12-10/17	BO;+ SS	DSN1465	12	1.5
1.4 TSI	Petrol	103/110	CPTA;CZEA	MTM	10/12-10/17	BO;+ SS	DSN1468	12	1.5
1.6	Petrol	63	CFNB		11/10-		DSN3006	12	1
1.6	Petrol	77	CLRA		01/10-	- SS	DSN3005	12	1.1
1.6 BiFuel	Petrol/ Liquified Petroleum Gas (LPG)	60	CNKA	MTM	01/11-05/14	- SS	DSN3006	12	1









Starters & Alternators

Application Tables - Starters

												
VW continued												
POLO (6R, 6C) (09-) continued												
1.6 TDI	Diesel	55/66/77	CAYA;CAYB;CAYC; CLNA	MTM	06/09-	BO;VA;- SS	DSN963	12	2.0			
1.6 TDI	Diesel	55/66/77	CAYA;CAYB;CAYC; CLNA	MTM	06/09-	BO;VA;+ SS	DSN1462	12	2.0			
1.8 GTI	Petrol	141	DAJA	MTM	11/14-10/17	BO;+ SS	DSN1468	12	1.5			
1.8 GTI	Petrol	141	DAJB	ATM	11/14-10/17	BO;+ SS	DSN1465	12	1.5			
POLO (9N) (01-09)												
1.2	Petrol	40/44	BBM;BMD	MTM	01/02-11/09		DSN3006	12	1			
1.2 12V	Petrol	47/51	AZQ;BME;BZG	MTM	10/01-11/09		DSN3006	12	1			
1.4	Petrol	61	BLM		08/02-11/09		DSN3006	12	1			
1.4 16V	Petrol	55	BKY		10/01-05/08		DSN3006	12	1			
1.4 16V	Petrol	59	BUD	MTM	05/06-11/09		DSN3005	12	1.1			
1.4 16V	Petrol	74	BBZ	MTM	10/01-05/08		DSN3006	12	1			
1.4 BiFuel	Petrol/ Liquified Petroleum Gas (LPG)	60	BUD	MTM	05/06-11/09		DSN3005	12	1.1			
1.4 TDI	Diesel	51	BWB		04/05-11/09		DSN3007	12	1.7			
1.4 TDI	Diesel	59	BMS;BNV	MTM	04/05-11/09		DSN3007	12	1.7			
1.6 16V	Petrol	77	BTS	ATM	05/06-11/09		DSN3005	12	1.1			
1.9 TDI	Diesel	74	ATD;AXR;BMT	MTM	10/01-11/09		DSN3007	12	1.7			
POLO (AW, BZ) (17-)												
1.0	Petrol	48/55	CHYB;CHYC;DFNB	MTM	06/17-	BO;+ SS	DSN1468	12	1.5			
1.0 MPI	Petrol	59	DFNA;DSGB		09/18-	+ SS	DSN1466	12	1.5			
1.0 TGI	Petrol/ Compressed Natural Gas (CNG)	66	DBYA	MTM	09/17-	BO;+ SS	DSN1468	12	1.5			
1.0 TSI	Petrol	70	CHZL;DKLA;DLAC	MTM	06/17-	BO;+ SS	DSN1468	12	1.5			
1.0 TSI	Petrol	70/85	CHZJ;CHZL;DKJA; DKLA;DKRF;DLAC	ATM	06/17-	BO;+ SS	DSN1465	12	1.5			
1.0 TSI	Petrol	85	CHZJ;DKJA;DKRF	MTM	09/17-	+ SS	DSN1466	12	1.5			
SCIROCCO (137, 138) (08-17)												
1.4 TSI	Petrol	92	CZCA	MTM	05/14-11/17	+ SS	DSN1466	12	1.5			
1.4 TSI	Petrol	110	CZDA	ATM	07/15-11/17	BO;+ SS	DSN1465	12	1.5			
2.0 R	Petrol	188	CDLC		11/09-11/17		DSN3005	12	1.1			
2.0 R	Petrol	195	CDLA	MTM	11/09-11/17		DSN3005	12	1.1			
2.0 R	Petrol	206	CDLK		05/14-11/17	- SS	DSN3005	12	1.1			
2.0 TDI	Diesel	100/103/ 110/135	CFHB;CFHC;CUUB; CUWA;CUXA	ATM	08/08-11/17	BO;VA;+ SS	DSN1460	12	2.0			
2.0 TDI	Diesel	100/103/ 110/135	CFHB;CFHC;CUUB; CUWA;CUXA	MTM	08/08-11/17	BO;VA;+ SS	DSN1461	12	2.0			
2.0 TDI	Diesel	125	CBBB	5MTM	05/09-11/17	+ SS	DSN1461	12	2.0			
2.0 TFSI	Petrol	155	CCZB	6MTM	11/09-05/14	- SS	DSN3005	12	1.1			
2.0 TSI	Petrol	132/162	CULA;CULC	ATM	11/13-11/17	BO;+ SS	DSN1464	12	1.5			
2.0 TSI	Petrol	132/162	CULA;CULC	MTM	11/13-11/17	BO;+ SS	DSN1468	12	1.5			
2.0 TSI	Petrol	155	CCZB	6MTM	11/09-11/17	- SS	DSN3005	12	1.1			
SHARAN (7M) (95-10)												
1.8 T 20V	Petrol	110	AWC	ATM	04/00-03/10	HI	DSN957	12	1.4			
1.9 TDI	Diesel	85	AUY;BVK	ATM	04/00-03/10	HI	DSN958	12	2.4			
1.9 TDI	Diesel	96	ASZ	MTM	11/02-03/10		DSN958	12	2.4			
1.9 TDI 4motion	Diesel	85	AUY	ATM	04/00-03/10	HI	DSN958	12	2.4			
2.8 VR6	Petrol	150	AYL	ATM	04/00-03/10	HI	DSN957	12	1.4			
2.8 VR6 4motion	Petrol	150	AYL	ATM	04/00-03/10	HI	DSN957	12	1.4			
SHARAN (7N) (10-)												
1.4 TSI	Petrol	110	CAVA;CNWB;CTHA	MTM	05/10-09/14	+ SS	DSN962	12	2.0			
1.4 TSI	Petrol	110	CAVA;CNWB;CTHA; CZDA;DJKA	ATM	05/10-	BO;+ SS	DSN1464	12	1.5			
1.4 TSI	Petrol	110	CTHA;CZDA;DJKA	MTM	09/14-	BO;+ SS	DSN1468	12	1.5			
2.0 TDI	Diesel	85/100/ 103/110/ 125/130/ 135	CFFA;CFFB;CFFE; CFGB;CFGC;CUVA; CUVC;CUWA;DFLA; DFLD;DFMA;DLTA; DLTC;DLUB	ATM	05/10-	BO;VA;+ SS	DSN1460	12	2.0			
2.0 TDI	Diesel	85/100/ 103/110/ 125/130/ 135	CFFA;CFFB;CFFE; CFGB;CFGC;CUVA; CUVC;CUWA;DFLA; DFLD;DFMA;DLTA; DLTC;DLUB	MTM	05/10-	BO;VA;+ SS	DSN1461	12	2.0			

										
VW continued										
SHARAN (7N) (10-) continued										
2.0 TDI 4motion	Diesel	103/110/135	CFFB;CUVC;DFLA;DFMA;DLTA	MTM	05/11-		BO;VA;+ SS	DSN1461	12	2.0
2.0 TDI 4motion	Diesel	110/135	CUVC;DFLA;DFMA;DLTA	ATM	05/15-		BO;VA;+ SS	DSN1460	12	2.0
2.0 TSI	Petrol	162	DEDA		05/15-		MY: 2016>;+ SS	DSN1464	12	1.5
T-CROSS (C11) (18-)										
1.0 TSI	Petrol	85	DKJA;DKRF		12/18-		+ SS	DSN1466	12	1.5
TIGUAN (5N) (07-18)										
1.4 TSI	Petrol	90	CAXA	MTM	08/10-09/14		+ SS	DSN962	12	2.0
1.4 TSI	Petrol	90/92/110/118	CAVA;CAVD;CAXA;CTHA;CTHD;CZDA;CZDB	MTM	04/14-07/18		BO;+ SS	DSN1468	12	1.5
1.4 TSI	Petrol	92/110/118	CTHA;CTHD;CZDA;CZDB	ATM	09/12-07/18		BO;+ SS	DSN1464	12	1.5
1.4 TSI	Petrol	110	CAVA	MTM	11/09-09/14		- SS	DSN3005	12	1.1
1.4 TSI	Petrol	110/118	CAVA;CAVD;CTHA;CTHD	MTM	11/09-09/14		-/+ SS	DSN962	12	2.0
1.4 TSI 4motion	Petrol	110	BWK;CAVA	MTM	11/09-09/14		- SS	DSN3005	12	1.1
1.4 TSI 4motion	Petrol	110/118	CAVA;CAVD;CTHA;CTHD	MTM	11/09-09/14		-/+ SS	DSN962	12	2.0
1.4 TSI 4motion	Petrol	110/118	CAVA;CAVD;CTHA;CTHD	MTM	04/14-07/18		BO;+ SS	DSN1468	12	1.5
1.4 TSI 4motion	Petrol	110/118	CTHA;CTHD	ATM	09/12-07/18		BO;+ SS	DSN1464	12	1.5
2.0 TDI	Diesel	81/103/110	CFFB;CFFD;CUVC;CUVE	MTM	11/09-07/18		BO;VA;+ SS	DSN1461	12	2.0
2.0 TDI	Diesel	103/110	CFFB;CUVC	ATM	11/09-07/18		BO;VA;+ SS	DSN1460	12	2.0
2.0 TDI 4motion	Diesel	100/103/110/125/130	CFFA;CFFB;CFGB;CFGC;CUVC	MTM	11/09-07/18		BO;VA;+ SS	DSN1461	12	2.0
2.0 TDI 4motion	Diesel	100/103/110/130/135	CFFA;CFFB;CFGC;CUVC;CUWA	ATM	11/09-07/18		BO;VA;+ SS	DSN1460	12	2.0
2.0 TFSI 4motion	Petrol	125	CAWA;CCTB;CCZC		09/07-07/18		- SS	DSN3005	12	1.1
2.0 TFSI 4motion	Petrol	147	CAWB;CCTA;CCZA		09/07-07/18		- SS	DSN3005	12	1.1
2.0 TSI 4motion	Petrol	132	CCZD		05/11-07/18		- SS	DSN3005	12	1.1
2.0 TSI 4motion	Petrol	155	CCZB	6MTM	05/11-07/18		- SS	DSN3005	12	1.1
TIGUAN (AD) (16-)										
1.4 TSI	Petrol	92/110	CZCA;CZDA;CZEA;DJVA	ATM	01/16-		BO;+ SS	DSN1464	12	1.5
1.4 TSI	Petrol	92/110	CZCA;CZDA;CZEA;DJVA	MTM	01/16-		BO;+ SS	DSN1468	12	1.5
1.4 TSI 4motion	Petrol	110	CZDA;CZEA	ATM	05/16-07/18		BO;+ SS	DSN1464	12	1.5
1.4 TSI 4motion	Petrol	110	CZDA;CZEA	MTM	05/16-07/18		BO;+ SS	DSN1468	12	1.5
1.5 TSI	Petrol	110	DADA;DPCA		11/18-08/19		MY: >2016;+ SS	DSN1462	12	2.0
1.6 TDI	Diesel	85	DGDB	MTM	05/16-06/20		BO;VA;+ SS	DSN1461	12	2.0
2.0 TDI	Diesel	81/85/110	CYKC;DFGA;DFGC;DTSA;DTSB	ATM	01/16-07/20		BO;VA;+ SS	DSN1460	12	2.0
2.0 TDI	Diesel	81/85/110	CYKC;DFGA;DFGC;DTSA;DTSB	MTM	01/16-07/20		BO;VA;+ SS	DSN1461	12	2.0
2.0 TDI 4motion	Diesel	110/140/176	CUAA;DBGC;DFGA;DFHA;DTSA;DTSB	ATM	01/16-07/20		BO;VA;+ SS	DSN1460	12	2.0
2.0 TDI 4motion	Diesel	110/140/176	CUAA;DBGC;DFGA;DFHA;DTSA;DTSB	MTM	01/16-07/20		BO;VA;+ SS	DSN1461	12	2.0
2.0 TSI 4motion	Petrol	132/162	CHHB;CZPA	ATM	01/16-		BO;+ SS	DSN1464	12	1.5
2.0 TSI 4motion	Petrol	132/162	CHHB;CZPA	MTM	01/16-		BO;+ SS	DSN1468	12	1.5
TIGUAN Allspace (BW2) (17-)										
1.4 TSI	Petrol	110	CZDA;CZEA	ATM	06/17-		BO;+ SS	DSN1464	12	1.5
1.4 TSI	Petrol	110	CZEA	MTM	06/17-		BO;+ SS	DSN1468	12	1.5
1.4 TSI E100 Flex	Flexfuel	110	CWLA	ATM	07/17-		BO;+ SS	DSN1464	12	1.5
1.5 TSI	Petrol	110	DADA;DPCA		09/18-		MY: >2016;+ SS	DSN1462	12	2.0
2.0 TDI	Diesel	110	DFGA	ATM	06/17-		BO;VA;+ SS	DSN1460	12	2.0
2.0 TDI	Diesel	110	DFGA	MTM	06/17-		BO;VA;+ SS	DSN1461	12	2.0
2.0 TDI 4motion	Diesel	110	DFGA	MTM	06/17-		BO;VA;+ SS	DSN1461	12	2.0
2.0 TDI 4motion	Diesel	110/176	CUAA;DFGA	ATM	06/17-		BO;VA;+ SS	DSN1460	12	2.0
2.0 TSI	Petrol	137	DGUA;DTEA	Automatic Transm ission, 8-speed	04/17-		BO;+ SS	DSN1468	12	1.5

										
VW continued										
TIGUAN Allspace (BW2) (17-) continued										
2.0 TSI 4motion	Petrol	137/162	CXDA;DGUA;DNJA;DTEA	Automatic Transmission, 8-speed	04/17-		BO;+ SS	DSN1468	12	1.5
2.0 TSI 4motion	Petrol	162	CXDA;DNJA	Automatic Transmission, 7-speed	07/17-		BO;+ SS	DSN1464	12	1.5
TOUAREG (7P) (10-18)										
3.0 V6 TDI	Diesel	150/165/176/180	CASA;CASD;CATA;CJGD;CJMA;CNRB;CRCA;CRCD;CVWA		01/10-03/18		+ SS	DSN965	12	2.0
3.0 V6 TDI	Diesel	193	CVVA		09/14-03/18			DSN965	12	2.0
TOURAN (1T1, 1T2) (03-10)										
1.6	Petrol	75	BGU;BSE;BSF		07/03-05/10			DSN3005	12	1.1
1.9 TDI	Diesel	66	BRU;BXF	MTM	11/04-05/10			DSN3007	12	1.7
1.9 TDI	Diesel	74/77	AVQ;BKC;BLS;BXE		02/03-05/10			DSN3007	12	1.7
2.0 FSI	Petrol	110	BVY;BVZ		10/03-01/07			DSN3005	12	1.1
2.0 TDI	Diesel	103/125	BKD;BMN;CFJA		08/03-05/10			DSN3008	12	1.7
2.0 TDI 8V	Diesel	103	BMM		12/05-05/10			DSN3008	12	1.7
TOURAN (1T3) (10-15)										
1.2 TSI	Petrol	77	CBZB	MTM	05/10-05/15		+ SS	DSN964	12	2.0
1.2 TSI	Petrol	77	CBZB	MTM	05/10-05/15		BO;+ SS	DSN1467	12	2.0
1.6 TDI	Diesel	66/77	CAYB;CAYC	MTM	05/10-05/15		BO;VA;- SS	DSN963	12	2.0
1.6 TDI	Diesel	66/77	CAYB;CAYC	MTM	05/10-05/15		BO;VA;+ SS	DSN1462	12	2.0
1.6 TDI	Diesel	77	CAYC	ATM	05/10-05/15		BO;VA;+ SS	DSN1463	12	2.0
2.0 TDI	Diesel	81	CLCA	MTM	11/10-05/15		BO;VA;- SS	DSN963	12	2.0
2.0 TDI	Diesel	81/103	CFHC;CLCA	MTM	05/10-05/15		BO;VA;+ SS	DSN1461	12	2.0
2.0 TDI	Diesel	81/103/125/130	CFHC;CFHF;CFJA;CFJB;CLCA	ATM	05/10-05/15		BO;VA;+ SS	DSN1460	12	2.0
TOURAN (5T) (15-)										
1.2 TSI 16V	Petrol	81	CYVB	MTM	05/15-		BO;+ SS	DSN1467	12	2.0
1.4 TSI	Petrol	110	CZDA	MTM	05/15-		+ SS	DSN1466	12	1.5
1.4 TSI	Petrol	110	CZDA	ATM	05/15-		BO;+ SS	DSN1465	12	1.5
1.6 TDI	Diesel	81/85	CRKB;DGDA	ATM	05/15-		BO;VA;+ SS	DSN1463	12	2.0
1.6 TDI	Diesel	81/85	CRKB;DGDA	MTM	05/15-		BO;VA;+ SS	DSN1462	12	2.0
1.8 TSI	Petrol	132	CJSA	ATM	11/15-		BO;+ SS	DSN1465	12	1.5
2.0 TDI	Diesel	110/140	DFEA;DFGA;DFHA	ATM	05/15-		BO;VA;+ SS	DSN1460	12	2.0
2.0 TDI	Diesel	110/140	DFEA;DFGA;DFHA	MTM	05/15-		BO;VA;+ SS	DSN1461	12	2.0
TRANSPORTER IV (70X, 7D) (90-03)										
2.4 D	Diesel	55	AJA		08/97-04/03			DSN3016	12	2
2.5	Petrol	81/85	AAF;ACU;AET;APL;AVT		09/90-06/03			DSN3016	12	2
2.5 Syncro	Petrol	81/85	AAF;ACU;AET;APL;AVT		08/92-04/03			DSN3016	12	2
2.5 TDI	Diesel	65/75/111	ACV;AHY;AJT;AXG;AYY		09/95-04/03			DSN3016	12	2
2.5 TDI Syncro	Diesel	75	ACV		09/95-04/03			DSN3016	12	2
2.8 VR6	Petrol	103	AES		11/95-05/00			DSN3016	12	2
TRANSPORTER V (7H, 7E, 7J) (03-15)										
1.9 TDI	Diesel	63	BRR		01/06-11/09		Ch No: WV1ZZZ7HZ7-000001 >>>	DSN3007	12	1.7
1.9 TDI	Diesel	63/75/77	AXB;AXC;BRS		04/03-11/09			DSN3007	12	1.7
2.0 BiTDI	Diesel	132	CFCA	6MTM	05/11-08/15		BO;VA;+ SS	DSN1461	12	2.0
2.0 BiTDI	Diesel	132	CFCA	ATM	05/11-08/15		BO;VA;+ SS	DSN1460	12	2.0
2.0 BiTDI 4motion	Diesel	132	CFCA	ATM	09/09-08/15		BO;VA;+ SS	DSN1460	12	2.0
2.0 TDI	Diesel	62/75	CAAA;CAAB	5MTM	09/09-08/15		BO;VA;- SS	DSN963	12	2.0
2.0 TDI	Diesel	62/75/84	CAAA;CAAB;CAAD	5MTM	05/11-08/15		BO;VA;+ SS	DSN1462	12	2.0
2.0 TDI	Diesel	100	CCHB		05/10-08/15			DSN1464	12	1.5
2.0 TDI	Diesel	103	CAAC;CCHA	6MTM	05/11-08/15		BO;VA;+ SS	DSN1461	12	2.0
2.0 TDI	Diesel	103	CAAC;CCHA	ATM	05/11-08/15		BO;VA;+ SS	DSN1460	12	2.0
2.0 TDI 4motion	Diesel	103	CAAC;CCHA	5MTM	09/09-08/15			DSN3007	12	1.7
2.0 TSI	Petrol	150	CJKA		05/11-08/15		- SS	DSN1464	12	1.5
TRANSPORTER VI (SF, SG) (15-)										
2.0 TDI	Diesel	62/75/84	CAAA;CAAB;CXGA;CXGB;CXHB	5MTM	04/15-		BO;VA;+ SS	DSN1462	12	2.0

		 kW				 NOTE			kW
VW continued									
TRANSPORTER VI (SF, SG) (15-) continued									
2.0 TDI	Diesel	103/110/132/150	CAAC;CFCA;CXEB;CXFA;CXHA	ATM	04/15-		BO;VA;+ SS	DSN1460	12 2.0
2.0 TDI	Diesel	103/132	CAAC;CFCA	6MTM	04/15-		BO;VA;+ SS	DSN1461	12 2.0
2.0 TDI 4motion	Diesel	103/110/132/150	CAAC;CFCA;CXEB;CXFA;CXHA	ATM	06/15-		BO;VA;+ SS	DSN1460	12 2.0
2.0 TDI 4motion	Diesel	103/132	CAAC;CFCA	6MTM	06/15-		BO;VA;+ SS	DSN1461	12 2.0
2.0 TSI	Petrol	110	CJKB	MTM	04/15-		BO;+ SS	DSN1468	12 1.5
2.0 TSI	Petrol	150	CJKA	ATM	04/15-		BO;+ SS	DSN1464	12 1.5
2.0 TSI 4motion	Petrol	150	CJKA	ATM	06/15-		BO;+ SS	DSN1464	12 1.5
T-ROC (A11) (17-)									
1.0 TSI	Petrol	85	CHZJ;DKRF	MTM	07/17-			DSN1466	12 1.5
1.5 TSI	Petrol	110	DADA;DPCA		11/17-		MY: >2016;+ SS	DSN1462	12 2.0
2.0 TDI 4motion	Diesel	110	DFFA	ATM	09/17-		BO;VA	DSN1460	12 2.0
2.0 TDI 4motion	Diesel	110	DFFA	MTM	09/17-		BO;VA	DSN1461	12 2.0
2.0 TSI 4motion	Petrol	140	CZPB;DKZA	ATM	07/17-		BO	DSN1464	12 1.5
2.0 TSI 4motion	Petrol	140	CZPB;DKZA	MTM	07/17-		BO	DSN1468	12 1.5
UP! (12, BL) (11-)									
1.0	Petrol	44/55	CHYA;CHYB;CHYE;CWRA;DAFA	MTM; ATM	08/11-08/20		BO;+ SS	DSN1468	12 1.5
1.0 EcoFuel	Petrol/ Compressed Natural Gas (CNG)	50	CPGA	MTM; ATM	11/12-		BO;+ SS	DSN1468	12 1.5
1.0 GTI	Petrol	85	DKRA		11/17-		+ SS	DSN1468	12 1.5
1.0 TSI	Petrol	66	CHZA;DKLC	MTM; ATM	05/16-09/18		BO;+ SS	DSN1468	12 1.5











DENSO Application Tables – Alternators





A











ABARTH										
124 Spider (348) (16-)										
1.4	Petrol	125	552 53 268		03/16-		DAN1332	14	150	
500 / 595 (C) (312) (07-)										
1.4	Petrol	99/103/ 118/132/ 140	312 A1.000;312 A3.000; 312 A9.000		08/08-	+ AC	DAN1083	14	120	
Grande PUNTO (05-12)										
1.4	Petrol	114/132	199 A8.000		12/07-12/12		DAN993	14	120	
PUNTO (12-)										
1.4	Petrol	120/132	955 A8.000		03/12-		DAN993	14	120	
ALFA ROMEO										
145 / 146 (94-01)										
1.4 i.e. 16V T.Spark	Petrol	76	AR 33503;AR 38501		11/96-01/01	-/+ AC	DAN1037	14	90	
1.6 16V T.Spark	Petrol	82	AR 32102		09/97-12/00	- AC	DAN1037	14	90	
1.6 16V T.Spark	Petrol	82	AR 32102		09/97-12/00	+ AC	DAN1140	14	105	
1.6 i.e.	Petrol	76	AR 33201		12/94-12/96	For vehicles without air conditioning	DAN1037	14	90	
1.6 i.e. 16V T.Spark	Petrol	88	AR 38201;AR 67601		11/96-10/01	- AC	DAN1037	14	90	
1.6 i.e. 16V T.Spark	Petrol	88	AR 38201;AR 67601		11/96-10/01	+ AC	DAN1140	14	105	
1.8 i.e. 16V	Petrol	106	AR 32201		03/98-01/01	- AC	DAN1037	14	90	
1.8 i.e. 16V	Petrol	106	AR 32201		03/98-01/01	+ AC	DAN1140	14	105	
1.8 i.e. 16V T.Spark	Petrol	103/106	AR 32201;AR 38401; AR 67106;AR 67199		11/96-01/01	- AC	DAN1037	14	90	
1.8 i.e. 16V T.Spark	Petrol	103/106	AR 32201;AR 38401; AR 67106;AR 67199		11/96-01/01	+ AC	DAN1140	14	105	
1.9 JTD	Diesel	77	AR 32302		02/99-01/01	Eng No: >1501771;- AC	DAN1037	14	90	
1.9 JTD	Diesel	77	AR 32302		02/99-01/01	Eng No: >1501771;+ AC	DAN1140	14	105	
1.9 JTD	Diesel	77	AR 32302		02/99-01/01	Eng No: 1501771>	DAN501	14	105	
2.0 16V	Petrol	114	AR 32301		03/97-10/01	Eng No: >1385143	DAN632	14	100	
2.0 16V	Petrol	114	AR 32301		03/97-10/01	Eng No: 1385143>	DAN1140	14	105	
2.0 16V T.Spark	Petrol	110	AR 67204		10/95-01/01	Eng No: >1385143	DAN632	14	100	
2.0 16V T.Spark	Petrol	110	AR 67204		10/95-01/01	Eng No: 1385143>	DAN1140	14	105	
147 (00-10)										
1.6 16V T.Spark	Petrol	88	AR 32104		01/01-03/10	- AC	DAN1037	14	90	
1.6 16V T.Spark	Petrol	88	AR 32104		01/01-03/10	Eng No: >2835764;+ AC	DAN1140	14	105	
1.6 16V T.Spark eco	Petrol	77	AR 37203	MTM	01/01-03/10	- AC	DAN1037	14	90	
1.6 16V T.Spark eco	Petrol	77	AR 37203		01/01-03/10	Eng No: >2835764;+ AC	DAN1140	14	105	
1.9 JTD 16V	Diesel	93/100/ 103	192 A5.000;192 B1.000; 937 A4.000		11/02-03/10		DAN501	14	105	
1.9 JTD 16V	Diesel	93/100/ 103	192 A5.000;192 B1.000; 937 A4.000		11/02-03/10		DAN502	14	120	
1.9 JTD 8V	Diesel	74/85	182 B9.000;937 A2.000		04/01-03/10		DAN501	14	105	
1.9 JTD 8V	Diesel	74/85	182 B9.000;937 A2.000		04/01-03/10		DAN502	14	120	
1.9 JTD 8V	Diesel	81	937 A2.000		10/00-08/02	For vehicles without air conditioning	DAN501	14	105	
1.9 JTD 16V	Diesel	110/125	937 A5.000;937 A6.000		09/04-03/10		DAN501	14	105	
1.9 JTD 16V	Diesel	110/125	937 A5.000;937 A6.000		09/04-03/10		DAN502	14	120	
1.9 JTD 8V	Diesel	85/88	937 A3.000;939 A7.000		10/04-03/10		DAN501	14	105	
1.9 JTD 8V	Diesel	85/88	937 A3.000;939 A7.000		10/04-03/10		DAN502	14	120	
2.0 16V T.Spark	Petrol	110	AR 32310		01/01-03/10	Eng No: >2835764	DAN1140	14	105	
155 (92-97)										
1.6 16V T.Spark	Petrol	88	AR 67601		05/96-12/97		DAN1037	14	90	
1.6 16V T.Spark	Petrol	88	AR 67601		05/96-12/97	+ AC	DAN1140	14	105	
1.7 T.Spark	Petrol	103	AR 67106	MTM	05/96-12/97	- AC	DAN1037	14	90	
2.0 16V Turbo Q4	Petrol	137/140	AR 67203		01/92-12/97		DAN632	14	100	
2.0 T.Spark	Petrol	110	AR 67204;AR 67299		03/95-12/97		DAN632	14	100	
156 (97-06)										
1.6 16V T.Spark	Petrol	82/88	AR 32102;AR 32103; AR 32104;AR 67601		09/97-05/06	Eng No: >2835764;- AC	DAN1037	14	90	
1.6 16V T.Spark	Petrol	82/88	AR 32102;AR 32103; AR 32104;AR 67601		09/97-05/06	Eng No: >2835764;+ AC	DAN1140	14	105	
1.8 16V T.Spark	Petrol	103/106	AR 32201;AR 32205		02/97-05/06	Eng No: >2835764;- AC	DAN1037	14	90	
1.8 16V T.Spark	Petrol	103/106	AR 32201;AR 32205		02/97-05/06	Eng No: >2835764;+ AC	DAN1140	14	105	
1.9 JTD	Diesel	77	AR 32302		09/97-10/00	Eng No: >1501771	DAN1140	14	105	
1.9 JTD	Diesel	77	AR 32302		09/97-10/00	Eng No: 1501771>	DAN501	14	105	
1.9 JTD	Diesel	81/85	937 A2.000;AR 37101		10/00-05/06		DAN501	14	105	
1.9 JTD	Diesel	81/85/ 93/100/ 110	192 B1.000;937 A2.000; 937 A4.000;937 A5.000; AR 37101		10/00-05/06		DAN502	14	120	
1.9 JTD 16V	Diesel	103	192 A5.000		11/02-05/06		DAN502	14	120	
2.0 16V T.Spark	Petrol	110/114	AR 32301;AR 32310		05/00-06/02	Eng No: >2835764	DAN1140	14	105	











									
ALFA ROMEO continued									
156 (97-06) continued									
2.0 16V T.Spark	Petrol	114	AR 32301;AR 32310		09/97-06/02	Eng No: >1385143	DAN632	14	100
2.0 16V T.Spark	Petrol	114	AR 32301;AR 32310		09/97-06/02	Eng No: 1385143>	DAN1140	14	105
2.0 JTS	Petrol	119	932 A2.000		03/01-09/05	Eng No: >1385143	DAN632	14	100
2.0 JTS	Petrol	119	932 A2.000		03/01-09/05	Eng No: 1385143>	DAN1140	14	105
2.4 JTD	Diesel	100	AR 32501		09/97-09/03		DAN1140	14	105
2.4 JTD	Diesel	100	AR 32501		09/97-09/03		DAN501	14	105
2.4 JTD	Diesel	100/103/ 110/120/ 129	839 A6.000;841 C000; 841 G.000;841 M.000; 841 N.000;AR 32501		09/97-05/06		DAN502	14	120
159 (05-11)									
1.8 Tbi	Petrol	147	939 B1.000		05/09-12/12		DAN1000	14	120
1.9 JTDM 16V	Diesel	100/110	937 A8.000;939 A2.000; 939 A8.000		09/05-05/07		DAN513	14	120
1.9 JTDM 16V	Diesel	100/110	937 A8.000;939 A2.000; 939 A8.000		09/05-05/07	+ Co	DAN1062	14	140
1.9 JTDM 16V	Diesel	100/110	937 A8.000;939 A2.000; 939 A8.000		05/07-11/11		DAN994	14	100
1.9 JTDM 16V	Diesel	100/110	937 A8.000;939 A2.000; 939 A8.000		05/07-11/11	+ Co	DAN995	14	120
1.9 JTDM 8V	Diesel	85/88	937 A7.000;939 A1.000; 939 A7.000		09/05-05/07		DAN513	14	120
1.9 JTDM 8V	Diesel	85/88	937 A7.000;939 A1.000; 939 A7.000		09/05-05/07	+ Co	DAN1062	14	140
1.9 JTDM 8V	Diesel	85/88	937 A7.000;939 A1.000; 939 A7.000		05/07-11/11		DAN994	14	100
1.9 JTDM 8V	Diesel	85/88	937 A7.000;939 A1.000; 939 A7.000		05/07-11/11	+ Co	DAN995	14	120
2.4 JTDM	Diesel	147/154	939 A3.000;939 A9.000		09/05-12/12		DAN936	14	150
2.4 JTDM Q4	Diesel	154	939 A9.000		05/07-11/11		DAN936	14	150
3.2 JTS	Petrol	191	939 A.000		01/08-11/11		DAN935	14	150
3.2 JTS Q4	Petrol	191	939 A.000		12/05-11/11		DAN935	14	150
166 (98-07)									
2.0 T.Spark	Petrol	110/114	AR 34103;AR 36301		09/98-06/07	Eng No: 1385143>2835764	DAN1140	14	105
2.0 T.Spark	Petrol	114	AR 34103		09/98-10/00	Eng No: >1385143	DAN632	14	100
2.4 JTD	Diesel	100	AR 34202		09/98-10/00		DAN1140	14	105
2.4 JTD	Diesel	103/110/ 120/129/ 132/136	839 A6.000;841 C000; 841 G.000;841 H.000; 841 M.000;841 N.000; 936 B.000		10/00-06/07		DAN502	14	120
BRERA (06-10)									
1.8 Tbi	Petrol	147	939 B1.000		05/09-06/10		DAN1000	14	120
2.0 JTDM	Diesel	120/125	844 A2.000;939 B3.000		03/08-06/10		DAN994	14	100
2.0 JTDM	Diesel	120/125	844 A2.000;939 B3.000		03/08-06/10	+ Co	DAN995	14	120
2.4 JTDM 20V	Diesel	147/154	939 A3.000;939 A9.000		01/06-03/11		DAN936	14	150
3.2 JTS	Petrol	191	939 A.000		03/08-06/10		DAN935	14	150
3.2 JTS Q4	Petrol	191	939 A.000		01/06-05/11		DAN935	14	150
GIULIA (952) (15-)									
2.2 D	Diesel	100/110/ 132	463 35 975;552 66 388; 552 68 532;552 71 040; 552 84 636		10/15-		DAN1146	14	150
2.2 D Q4	Diesel	154	552 68 818;552 84 529		11/16-		DAN1146	14	150
GIULIETTA (10-)									
1.4 BiFuel	Petrol/ Liquified Petroleum Gas (LPG)	88	198 A4.000		12/11-02/17		DAN993	14	120
1.4 BiFuel	Petrol/ Liquified Petroleum Gas (LPG)	88	198 A4.000		12/11-02/17	+ Ho	DAN1329	14	150
1.4 TB	Petrol	77/85/ 88/120/ 125	198 A4.000;940 A2.000; 940 A6.000;940 B1.000; 940 B7.000;940 B8.000; 955 A8.000		04/10-	+ Ho;EU5	DAN1329	14	150
1.4 TB	Petrol	77/85/ 88/120/ 125	198 A4.000;940 A2.000; 940 A6.000;940 B1.000; 940 B7.000;940 B8.000; 955 A8.000		04/10-	EU5	DAN993	14	120
1.4 TB	Petrol	77/88/ 125	198 A4.000;940 A2.000; 940 B1.000;940 B7.000; 940 B8.000		04/10-	+ Ho;EU6	DAN1332	14	150























A











ALFA ROMEO continued									
GIULIETTA (10-) continued									
1.4 TB	Petrol	77/88/125	198 A4.000;940 A2.000; 940 B1.000;940 B7.000; 940 B8.000		04/10-	EU6	DAN1078	14	120
1.4 TB	Petrol	110	940 C2.000		09/14-		DAN1078	14	120
1.4 TB	Petrol	110	940 C2.000		09/14-	+ Ho	DAN1332	14	150
1.6 JTDM	Diesel	77	940 A3.000		04/10-	+ Co;+ Ho;EU5	DAN1123	14	150
1.6 JTDM	Diesel	77	940 A3.000		04/10-	+ Co;+ Ho;EU5+	DAN1145	14	150
1.6 JTDM	Diesel	77	940 A3.000		04/10-	EU5	DAN1084	14	120
1.6 JTDM	Diesel	77	940 A3.000		04/10-	EU5+	DAN1121	14	120
1.6 JTDM	Diesel	88	940 C1.000;940 C5.000; 552 80 444		02/15-	+ SS	DAN1121	14	120
1.8	Petrol	173	940 A1.000		04/11-12/13	- FDC	DAN1000	14	120
1.8 Tbi	Petrol	169/173	940 A1.000		04/10-02/16		DAN1000	14	120
1.8 Tbi	Petrol	169/173	940 A1.000		04/10-02/16	+ FDC	DAN1123	14	150
1.8 Tbi	Petrol	177	940 B2.000;960 A1.000		09/13-	EU5	DAN1000	14	120
1.8 Tbi	Petrol	177	940 B2.000;960 A1.000		09/13-	EU6	DAN1330	14	150
2.0 JTDM	Diesel	100/103/110/120/125/129	552 83 099;940 A4.000; 940 A5.000;940 A7.000; 940 A8.000;940 B4.000; 940 B5.000;940 B6.000; 940 B9.000;940 C3.000; 940 C4.000		04/10-	+ Co;+ Ho;EU5	DAN1123	14	150
2.0 JTDM	Diesel	100/103/110/120/125/129	552 83 099;940 A4.000; 940 A5.000;940 A7.000; 940 A8.000;940 B4.000; 940 B5.000;940 B6.000; 940 B9.000;940 C3.000; 940 C4.000		04/10-	+ Co;+ Ho;EU5+	DAN1145	14	150
2.0 JTDM	Diesel	100/103/110/120/125/129	552 83 099;940 A4.000; 940 A5.000;940 A7.000; 940 A8.000;940 B4.000; 940 B5.000;940 B6.000; 940 B9.000;940 C3.000; 940 C4.000		04/10-	+ Co;+ Ho;EU6	DAN1146	14	150
2.0 JTDM	Diesel	100/103/110/120/125/129	552 83 099;940 A4.000; 940 A5.000;940 A7.000; 940 A8.000;940 B4.000; 940 B5.000;940 B6.000; 940 B9.000;940 C3.000; 940 C4.000		04/10-	EU5	DAN1066	14	120
2.0 JTDM	Diesel	100/103/110/120/125/129	552 83 099;940 A4.000; 940 A5.000;940 A7.000; 940 A8.000;940 B4.000; 940 B5.000;940 B6.000; 940 B9.000;940 C3.000; 940 C4.000		04/10-	EU5+	DAN1121	14	120
2.0 JTDM	Diesel	100/103/110/120/125/129	552 83 099;940 A4.000; 940 A5.000;940 A7.000; 940 A8.000;940 B4.000; 940 B5.000;940 B6.000; 940 B9.000;940 C3.000; 940 C4.000		04/10-	EU6	DAN1121	14	120
GT (03-10)									
1.9 JTD	Diesel	110/125	937 A5.000;937 A6.000		11/03-09/10		DAN501	14	105
1.9 JTD	Diesel	110/125	937 A5.000;937 A6.000		11/03-09/10		DAN502	14	120
GTV (95-05)									
1.8 16V	Petrol	106	AR 32201		05/98-10/05	- AC	DAN1037	14	90
1.8 16V	Petrol	106	AR 32201		05/98-10/05	+ AC	DAN1140	14	105
2.0 T.Spark 16V	Petrol	110/114	AR 16201;AR 32301; AR 32310		06/95-10/05	Eng No: >1385143	DAN632	14	100
2.0 T.Spark 16V	Petrol	110/114	AR 16201;AR 32301; AR 32310		06/95-10/05	Eng No: 1385143>2835764	DAN1140	14	105
MITO (08-)									
0.9 TwinAir	Petrol	63/74/77	199 B6.000;312 A2.000		07/11-		DAN1078	14	120
0.9 TwinAir	Petrol	74/77	199 B6.000		04/13-	+ Co	DAN1089	14	120
1.3 D Multijet	Diesel	59	199 B8.000		12/13-		DAN1086	14	120
1.3 D Multijet	Diesel	62	199 B4.000		03/11-	+ AC	DAN1086	14	120
1.3 D Multijet	Diesel	66	199 A3.000;955 B2.000		08/08-08/10	-/+ AC	DAN996	14	90
1.3 D Multijet	Diesel	70	199 B1.000;330 A1.000		09/09-12/18	- AC	DAN1001	14	105
1.3 D Multijet	Diesel	70	199 B1.000;330 A1.000		09/09-12/18	+ AC	DAN997	14	120
1.4	Petrol	51/58	350 A1.000;955 A9.000		03/11-	- SS;+ AC	DAN517	14	70
1.4	Petrol	51/58	350 A1.000;955 A9.000		03/11-	+ SS;+ AC	DAN999	14	120
1.4	Petrol	51/58	955 A1.000;955 A9.000		08/08-	- AC	DAN998	14	70
1.4	Petrol	58	350 A1.000		03/11-	- AC	DAN1005	14	105
1.4	Petrol	58	955 A1.000		08/08-08/13	+ AC	DAN519	14	90
1.4	Petrol	70	199 A6.000		09/08-08/13	+ AC	DAN1085	14	120
1.4 MultiAir	Petrol	77	955 A6.000		09/09-08/13	+ AC	DAN1085	14	120











										
ALFA ROMEO continued										
MITO (08-) continued										
1.4 MultiAir	Petrol	99/120/125	940 A2.000;955 A2.000;955 A7.000;955 A8.000		09/09-	+ AC		DAN993	14	120
1.4 TJet	Petrol	88/110/114	198 A1.000;198 A4.000;199 A8.000		08/08-	- AC		DAN1004	14	90
1.4 TJet	Petrol	88/110/114	198 A1.000;198 A4.000;199 A8.000		08/08-	+ AC		DAN993	14	120
1.6 JTDM	Diesel	85/88	198 A2.000;955 A3.000;955 A4.000		08/08-	- AC		DAN994	14	100
1.6 JTDM	Diesel	85/88	198 A2.000;955 A3.000;955 A4.000		08/08-	+ AC		DAN995	14	120
SPIDER (94-05)										
1.8 16V	Petrol	106	AR 32201		05/98-04/05	- AC		DAN1037	14	90
1.8 16V	Petrol	106	AR 32201		05/98-04/05	+ AC		DAN1140	14	105
2.0 T.Spark 16V	Petrol	110/114	AR 16201;AR 32301;AR 32310		06/95-04/05	Eng No: >1385143		DAN632	14	100
2.0 T.Spark 16V	Petrol	110/114	AR 16201;AR 32301;AR 32310		06/95-04/05	Eng No: 1385143>2835764		DAN1140	14	105
2.0 T.Spark 16V	Petrol	114	AR 32301		05/98-08/00			DAN1037	14	90
SPIDER (06-10)										
1.8 Tbi	Petrol	147	939 B1.000		05/09-03/11			DAN1000	14	120
2.0 JTDM	Diesel	120/125	844 A2.000;939 B3.000		04/09-03/11			DAN994	14	100
2.0 JTDM	Diesel	120/125	844 A2.000;939 B3.000		04/09-03/11	+ Co		DAN995	14	120
2.4 JTDM	Diesel	147/154	939 A3.000		03/06-03/11			DAN936	14	150
3.2 JTS	Petrol	191	939 A.000		03/08-03/11			DAN935	14	150
3.2 JTS Q4	Petrol	191	939 A.000		03/06-03/11			DAN935	14	150
AUDI										
A1 (8X) (10-18)										
1.6 TDI	Diesel	66/77	CAYB;CAYC		05/10-04/15	BO;VA;+ SS		DAN1328	14	140
2.0 TDI	Diesel	100/105	CFHB;CFHD		09/11-04/15	BO;VA;+ SS		DAN1328	14	140
2.0 TFSI quattro	Petrol	188	CDLH		03/12-11/12	+ SS		DAN1328	14	140
A3 (8P) (03-13)										
1.6 TDI	Diesel	66/77	CAYB;CAYC		05/09-03/13	BO;VA;+ SS		DAN1328	14	140
2.0 TDI	Diesel	100/103/125	CFFA;CFFB;CFGB;CLJA		11/09-03/13	BO;VA;+ SS		DAN1328	14	140
2.0 TDI quattro	Diesel	103/125	CFFB;CFGB		11/09-03/13	BO;VA;+ SS		DAN1328	14	140
A3 Convertible (8P7) (08-13)										
1.6 TDI	Diesel	77	CAYC		05/09-05/13	BO;VA;+ SS		DAN1328	14	140
2.0 TDI	Diesel	100/103	CFFA;CFFB		11/09-05/13	BO;VA;+ SS		DAN1328	14	140
Q3 (8U) (11-18)										
2.0 TDI	Diesel	100/103/130	CFFA;CFFB;CFGC;CLJA;CUVB;DFTB		06/11-04/15	BO;VA		DAN1328	14	140
2.0 TDI quattro	Diesel	103/120/130	CFFB;CFGC;CFGD;CLLB		06/11-04/15	BO;VA		DAN1328	14	140
TT (8J) (06-14)										
2.0 TDI quattro	Diesel	125	CFGB		05/10-06/14	BO;VA;+ SS		DAN1328	14	140
BMW										
1 (F20, F21) (10-)										
114 i 1.6	Petrol	75	N13 B16 A		12/11-			DAN1125	14	170
116 i 1.5	Petrol	80	B38 B15 A		03/15-			DAN1462	14	180
116 i 1.5	Petrol	80	B38 B15 A		03/15-			DAN1466	14	190
116 i 1.6	Petrol	100	N13 B16 A		07/11-			DAN1125	14	170
118 d	Diesel	110	B47 D20 A		03/15-			DAN1464	14	180
118 i 1.5	Petrol	100	B38 B15 A		03/15-			DAN1462	14	180
118 i 1.5	Petrol	100	B38 B15 A		03/15-			DAN1466	14	190
118 i 1.5	Petrol	100	B38 B15 A		03/15-			DAN1471	14	220
118 i 1.6	Petrol	100/125	N13 B16 A		07/11-			DAN1125	14	170
118 xd	Diesel	110	B47 D20 A		03/15-			DAN1464	14	180
120 d	Diesel	140	B47 D20 A		03/15-			DAN1464	14	180
120 i 1.6	Petrol	130	N13 B16 A		03/15-			DAN1125	14	170
120 i 2.0	Petrol	135	B48 B20 A		07/16-			DAN1462	14	180
120 i 2.0	Petrol	135	B48 B20 A		07/16-			DAN1466	14	190
120 xd	Diesel	140	B47 D20 A		03/15-			DAN1464	14	180
125 d	Diesel	165	B47 D20 B		03/15-			DAN1464	14	180
125 i	Petrol	160/175	N20 B20 A		12/11-			DAN1126	14	170
125 i	Petrol	165	B48 B20 B		10/15-			DAN1462	14	180
125 i	Petrol	165	B48 B20 B		10/15-			DAN1466	14	190
M 135 i	Petrol	235/240	N55 B30 A	ATM	03/12-			DAN1135	14	210
M 135 i	Petrol	235/240	N55 B30 A	MTM	03/12-			DAN1137	14	210
M 135 xi	Petrol	235	N55 B30 A		03/12-			DAN1135	14	210
M 135 xi	Petrol	240	N55 B30 A	ATM	03/15-			DAN1135	14	210











									
BMW continued									
1 (F20, F21) (10-) continued									
M 135 xi	Petrol	240	N55 B30 A	MTM	03/15-		DAN1137	14	210
1 Coupe/Convertible (E82, E88) (07-13)									
135 i	Petrol	225/240	N55 B30 A		03/12-12/13		DAN1133	14	170
2 Active Tourer (F45) (14-)									
214 d	Diesel	70	B37 C15 A		07/14-02/18		DAN1464	14	180
216 d	Diesel	85	B37 C15 A		03/14-		DAN1464	14	180
216 i	Petrol	75	B38 A15 A		02/15-02/18		DAN1464	14	180
218 d	Diesel	100/110	B47 C20 A;B47 C20 B		11/13-		DAN1464	14	180
218 i	Petrol	100	B38 A15 A		07/14-		DAN1464	14	180
218 xd	Diesel	100/110	B47 C20 A;B47 C20 B		12/14-		DAN1464	14	180
220 d	Diesel	120/140	B47 C20 A;B47 C20 B		03/14-		DAN1464	14	180
220 i	Petrol	120/141	B48 A20 A;B48 A20 F		03/14-		DAN1464	14	180
220 xd	Diesel	120/140	B47 C20 A;B47 C20 B		03/14-		DAN1464	14	180
225 i	Petrol	170	B48 A20 B		11/13-		DAN1464	14	180
225 xi	Petrol	170	B48 A20 B		03/14-		DAN1464	14	180
2 Coupe/Convertible (F22, F23) (13-)									
218 d	Diesel	100/110	B47 D20 A;N47 D20 C		03/14-		DAN1464	14	180
218 i	Petrol	100	B38 B15 A		03/15-		DAN1462	14	180
218 i	Petrol	100	B38 B15 A		03/15-		DAN1466	14	190
218 i	Petrol	100	B38 B15 A		03/15-		DAN1471	14	220
220 d	Diesel	120/140	B47 D20 A;N47 D20 C		03/14-		DAN1464	14	180
220 i	Petrol	135	B48 B20 A		09/15-		DAN1462	14	180
220 i	Petrol	135	B48 B20 A		09/15-		DAN1466	14	190
220 i	Petrol	135	N20 B20 A;N20 B20 B		10/13-		DAN1126	14	170
220 xd	Diesel	120/140	B47 D20 A		06/14-		DAN1464	14	180
225 d	Diesel	165	B47 D20 B		07/15-		DAN1464	14	180
228 i	Petrol	180	N20 B20 A;N26 B20 A		07/14-		DAN1126	14	170
230 i	Petrol	185	B46 B20 B;B48 B20 B		07/16-		DAN1462	14	180
230 i	Petrol	185	B46 B20 B;B48 B20 B		07/16-		DAN1466	14	190
M 235 i	Petrol	240	N55 B30 A	ATM	10/13-		DAN1135	14	210
M 235 i	Petrol	240	N55 B30 A	MTM	10/13-		DAN1137	14	210
M 235 xi	Petrol	240	N55 B30 A	ATM	07/14-		DAN1135	14	210
M 235 xi	Petrol	240	N55 B30 A	MTM	07/14-		DAN1137	14	210
M2 3.0	Petrol	272	N55 B30 A		11/15-06/18		DAN1137	14	210
M2 3.0 Competition	Petrol	302	S55 B30 A		06/18-		DAN1468	14	210
2 Gran Tourer (F46) (15-)									
214 d	Diesel	70	B37 C15 A		07/15-02/18		DAN1464	14	180
216 d	Diesel	85	B37 C15 A		08/14-		DAN1464	14	180
216 i	Petrol	75	B38 A15 A		09/14-02/18		DAN1464	14	180
218 d	Diesel	100/110	B47 C20 A;B47 C20 B		07/14-		DAN1464	14	180
218 i	Petrol	100/103	B38 A15 A		03/15-		DAN1464	14	180
218 xd	Diesel	100/110	B47 C20 A;B47 C20 B		03/15-		DAN1464	14	180
220 d	Diesel	120/140	B47 C20 A;B47 C20 B		09/14-		DAN1464	14	180
220 i	Petrol	120/141	B48 A20 A		03/15-		DAN1464	14	180
220 xd	Diesel	120/140	B47 C20 A;B47 C20 B		03/15-		DAN1464	14	180
3 (E90, E91) (05-12)									
335 i	Petrol	225/240	N55 B30 A		03/12-06/12		DAN1133	14	170
335 xi	Petrol	225/240	N55 B30 A		03/12-06/12		DAN1133	14	170
3 (F30, F31) (11-19)									
316 d	Diesel	85	B47 D20 A		03/12-06/19		DAN1464	14	180
316 i	Petrol	100	N13 B16 A		07/12-08/16		DAN1125	14	170
318 d	Diesel	100/110	B47 D20 A		03/12-06/19		DAN1464	14	180
318 i	Petrol	100	B38 B15 A		07/15-06/19		DAN1462	14	180
318 i	Petrol	100	B38 B15 A		07/15-06/19		DAN1466	14	190
318 i	Petrol	100	B38 B15 A		07/15-06/19		DAN1471	14	220
318 xd	Diesel	110	B47 D20 A		07/15-02/18		DAN1464	14	180
320 d	Diesel	120/140	B47 D20 A		11/11-06/19		DAN1464	14	180
320 i 1.6	Petrol	125	N13 B16 A		11/12-06/16		DAN1125	14	170
320 i 2.0	Petrol	120/135	N20 B20 A;N20 B20 B; N20 B20 D		03/12-10/18		DAN1126	14	170
320 i 2.0	Petrol	120/135	N20 B20 A;N20 B20 B; N20 B20 D		03/12-10/18		DAN1127	14	210
320 i 2.0	Petrol	135	B48 B20 A		07/15-06/19		DAN1462	14	180
320 i 2.0	Petrol	135	B48 B20 A		07/15-06/19		DAN1466	14	190
320 i 2.0	Petrol	135	B48 B20 A		07/15-06/19		DAN1471	14	220
320 xd	Diesel	120/140	B47 D20 A		08/12-06/19		DAN1464	14	180
320 xi	Petrol	120/135	N20 B20 A;N20 B20 B		07/12-10/18		DAN1126	14	170

									
BMW continued									
3 (F30, F31) (11-19) continued									
320 xi	Petrol	120/135	N20 B20 A;N20 B20 B		07/12-10/18		DAN1127	14	210
320 xi	Petrol	135	B48 B20 A		07/15-06/19		DAN1462	14	180
320 xi	Petrol	135	B48 B20 A		07/15-06/19		DAN1466	14	190
320 xi	Petrol	135	B48 B20 A		07/15-06/19		DAN1471	14	220
325 d	Diesel	165	B47 D20 B		03/16-02/18		DAN1464	14	180
328 i	Petrol	180	N20 B20 A;N20 B20 C; N26 B20 A		11/11-10/18		DAN1126	14	170
328 i	Petrol	180	N20 B20 A;N20 B20 C; N26 B20 A		11/11-10/18		DAN1127	14	210
328 xi	Petrol	180	N20 B20 A;N26 B20 A		07/12-08/16		DAN1126	14	170
328 xi	Petrol	180	N20 B20 A;N26 B20 A		07/12-08/16		DAN1127	14	210
330 i	Petrol	185	B46 B20 B;B48 B20 A; B48 B20 B		07/15-06/19		DAN1462	14	180
330 i	Petrol	185	B46 B20 B;B48 B20 A; B48 B20 B		07/15-06/19		DAN1466	14	190
330 i	Petrol	185	B46 B20 B;B48 B20 A; B48 B20 B		07/15-06/19		DAN1471	14	220
330 xi	Petrol	185	B46 B20 B;B48 B20 A; B48 B20 B		07/15-06/19		DAN1462	14	180
330 xi	Petrol	185	B46 B20 B;B48 B20 A; B48 B20 B		07/15-06/19		DAN1466	14	190
330 xi	Petrol	185	B46 B20 B;B48 B20 A; B48 B20 B		07/15-06/19		DAN1471	14	220
335 i	Petrol	225/240/ 250	N55 B30 A	ATM	03/12-07/15		DAN1135	14	210
335 i	Petrol	225/240/ 250	N55 B30 A	MTM	03/12-07/15		DAN1137	14	210
335 xi	Petrol	225/240/ 250	N55 B30 A	ATM	03/12-07/15		DAN1135	14	210
335 xi	Petrol	225/240/ 250	N55 B30 A	MTM	03/12-07/15		DAN1137	14	210
M3 3.0	Petrol	317	S55 B30 A		03/14-10/18		DAN1468	14	210
M3 3.0 Competition	Petrol	331	S55 B30 A		03/16-10/18		DAN1468	14	210
3 Coupe/Convertible (E92, E93) (06-13)									
335 i	Petrol	225/240	N55 B30 A		03/12-10/13		DAN1133	14	170
335 xi	Petrol	225/240	N55 B30 A		03/12-12/13		DAN1133	14	170
3 Gran Turismo (F34) (13-)									
318 d	Diesel	110	B47 D20 A		07/15-		DAN1464	14	180
320 d	Diesel	120/140	B47 D20 A		03/13-		DAN1464	14	180
320 i	Petrol	120/135	N20 B20 A;N20 B20 B		03/13-06/16		DAN1126	14	170
320 i	Petrol	120/135	N20 B20 A;N20 B20 B		03/13-06/16		DAN1127	14	210
320 i	Petrol	135	B48 B20 A		07/16-		DAN1462	14	180
320 i	Petrol	135	B48 B20 A		07/16-		DAN1466	14	190
320 i	Petrol	135	B48 B20 A		07/16-		DAN1471	14	220
320 xd	Diesel	120/140	B47 D20 A		07/13-		DAN1464	14	180
320 xi	Petrol	120/135	N20 B20 A;N20 B20 B		11/12-06/16		DAN1126	14	170
320 xi	Petrol	120/135	N20 B20 A;N20 B20 B		11/12-06/16		DAN1127	14	210
320 xi	Petrol	135	B48 B20 A		07/16-		DAN1462	14	180
320 xi	Petrol	135	B48 B20 A		07/16-		DAN1466	14	190
320 xi	Petrol	135	B48 B20 A		07/16-		DAN1471	14	220
325 d	Diesel	165	B47 D20 B		07/16-02/18		DAN1464	14	180
328 i	Petrol	180	N20 B20 A;N26 B20 A		03/13-06/16		DAN1126	14	170
328 i	Petrol	180	N20 B20 A;N26 B20 A		03/13-06/16		DAN1127	14	210
328 xi	Petrol	180	N20 B20 A;N26 B20 A		07/13-06/16		DAN1126	14	170
328 xi	Petrol	180	N20 B20 A;N26 B20 A		07/13-06/16		DAN1127	14	210
330 i	Petrol	185	B48 B20 B		07/16-		DAN1462	14	180
330 i	Petrol	185	B48 B20 B		07/16-		DAN1466	14	190
330 i	Petrol	185	B48 B20 B		07/16-		DAN1471	14	220
330 xi	Petrol	185	B46 B20 B;B48 B20 B		07/16-		DAN1462	14	180
330 xi	Petrol	185	B46 B20 B;B48 B20 B		07/16-		DAN1466	14	190
330 xi	Petrol	185	B46 B20 B;B48 B20 B		07/16-		DAN1471	14	220
335 i	Petrol	225/240/ 250	N55 B30 A	ATM	03/13-06/16		DAN1135	14	210
335 i	Petrol	225/240/ 250	N55 B30 A	MTM	03/13-06/16		DAN1137	14	210
335 xi	Petrol	225/240/ 250	N55 B30 A	ATM	03/13-06/16		DAN1135	14	210
335 xi	Petrol	225/240/ 250	N55 B30 A	MTM	03/13-06/16		DAN1137	14	210
4 Coupe/Convertible (F32, F33) (13-)									
418 d	Diesel	100/110	B47 D20 A		03/15-10/17		DAN1464	14	180











										
BMW continued										
4 Coupe/Convertible (F32, F33) (13-) continued										
418 i	Petrol	100	B38 B15 A		03/16-			DAN1462	14	180
418 i	Petrol	100	B38 B15 A		03/16-			DAN1466	14	190
418 i	Petrol	100	B38 B15 A		03/16-			DAN1471	14	220
420 d	Diesel	120/140	B47 D20 A		07/13-			DAN1464	14	180
420 i	Petrol	120/135	B48 B20 A		03/16-			DAN1462	14	180
420 i	Petrol	120/135	B48 B20 A		03/16-			DAN1466	14	190
420 i	Petrol	120/135	B48 B20 A		03/16-			DAN1471	14	220
420 i	Petrol	120/135	N20 B20 A;N20 B20 B		11/13-02/17			DAN1126	14	170
420 i	Petrol	120/135	N20 B20 A;N20 B20 B		11/13-02/17			DAN1127	14	210
420 xd	Diesel	120/140	B47 D20 A		11/13-			DAN1464	14	180
420 xi	Petrol	120/135	B48 B20 A		03/16-			DAN1462	14	180
420 xi	Petrol	120/135	B48 B20 A		03/16-			DAN1466	14	190
420 xi	Petrol	120/135	B48 B20 A		03/16-			DAN1471	14	220
420 xi	Petrol	120/135	N20 B20 A;N20 B20 B		11/13-02/16			DAN1126	14	170
420 xi	Petrol	120/135	N20 B20 A;N20 B20 B		11/13-02/16			DAN1127	14	210
425 d	Diesel	165	B47 D20 B		03/16-02/18			DAN1464	14	180
428 i	Petrol	180	N20 B20 A;N26 B20 A		07/13-02/17			DAN1126	14	170
428 i	Petrol	180	N20 B20 A;N26 B20 A		07/13-02/17			DAN1127	14	210
428 xi	Petrol	180	N20 B20 A;N26 B20 A		07/13-02/16			DAN1126	14	170
428 xi	Petrol	180	N20 B20 A;N26 B20 A		07/13-02/16			DAN1127	14	210
430 i	Petrol	185	B46 B20 B;B48 B20 B		03/16-			DAN1462	14	180
430 i	Petrol	185	B46 B20 B;B48 B20 B		03/16-			DAN1466	14	190
430 i	Petrol	185	B46 B20 B;B48 B20 B		03/16-			DAN1471	14	220
430 xi	Petrol	185	B46 B20 B;B48 B20 B		03/16-			DAN1462	14	180
430 xi	Petrol	185	B46 B20 B;B48 B20 B		03/16-			DAN1466	14	190
430 xi	Petrol	185	B46 B20 B;B48 B20 B		03/16-			DAN1471	14	220
435 i	Petrol	225/250	N55 B30 A	ATM	07/13-02/16			DAN1135	14	210
435 i	Petrol	225/250	N55 B30 A	MTM	07/13-02/16			DAN1137	14	210
435 xi	Petrol	225/250	N55 B30 A	ATM	07/13-02/16			DAN1135	14	210
435 xi	Petrol	225/250	N55 B30 A	MTM	07/13-02/16			DAN1137	14	210
M4 3.0	Petrol	317	S55 B30 A		03/14-			DAN1468	14	210
M4 3.0 Competition	Petrol	331	S55 B30 A		03/16-			DAN1468	14	210
M4 3.0 CS	Petrol	338	S55 B30 A		07/17-06/19			DAN1468	14	210
M4 3.0 GTS	Petrol	368	S55 B30 A		03/16-02/17			DAN1468	14	210
4 Gran Coupe (F36) (14-)										
418 d	Diesel	100/110	B47 D20 A		03/14-			DAN1464	14	180
418 i	Petrol	100	B38 B15 A		07/15-			DAN1462	14	180
418 i	Petrol	100	B38 B15 A		07/15-			DAN1466	14	190
418 i	Petrol	100	B38 B15 A		07/15-			DAN1471	14	220
420 d	Diesel	120/140	B47 D20 A		03/14-			DAN1464	14	180
420 i	Petrol	120/135	B48 B20 A		03/16-			DAN1462	14	180
420 i	Petrol	120/135	B48 B20 A		03/16-			DAN1466	14	190
420 i	Petrol	120/135	B48 B20 A		03/16-			DAN1471	14	220
420 i	Petrol	120/135	N20 B20 B		03/14-02/17			DAN1126	14	170
420 i	Petrol	120/135	N20 B20 B		03/14-02/17			DAN1127	14	210
420 xd	Diesel	120/140	B47 D20 A		03/14-			DAN1464	14	180
420 xi	Petrol	120/135	B48 B20 A		03/16-			DAN1462	14	180
420 xi	Petrol	120/135	B48 B20 A		03/16-			DAN1466	14	190
420 xi	Petrol	120/135	B48 B20 A		03/16-			DAN1471	14	220
420 xi	Petrol	120/135	N20 B20 B		07/14-02/16			DAN1126	14	170
420 xi	Petrol	120/135	N20 B20 B		07/14-02/16			DAN1127	14	210
425 d	Diesel	155/165	B47 D20 B		03/16-02/18			DAN1464	14	180
428 i	Petrol	180	N20 B20 A;N26 B20 A		03/14-06/16			DAN1126	14	170
428 i	Petrol	180	N20 B20 A;N26 B20 A		03/14-06/16			DAN1127	14	210
428 xi	Petrol	180	N20 B20 A;N26 B20 A		03/14-02/16			DAN1126	14	170
428 xi	Petrol	180	N20 B20 A;N26 B20 A		03/14-02/16			DAN1127	14	210
430 i	Petrol	185	B46 B20 B;B48 B20 B		03/16-			DAN1462	14	180
430 i	Petrol	185	B46 B20 B;B48 B20 B		03/16-			DAN1466	14	190
430 i	Petrol	185	B46 B20 B;B48 B20 B		03/16-			DAN1471	14	220
430 xi	Petrol	185	B46 B20 B;B48 B20 B		03/16-			DAN1462	14	180
430 xi	Petrol	185	B46 B20 B;B48 B20 B		03/16-			DAN1466	14	190
430 xi	Petrol	185	B46 B20 B;B48 B20 B		03/16-			DAN1471	14	220
435 i	Petrol	225/250	N55 B30 A	ATM	03/14-02/16			DAN1135	14	210
435 i	Petrol	225/250	N55 B30 A	MTM	03/14-02/16			DAN1137	14	210
435 xi	Petrol	225/250	N55 B30 A	ATM	07/14-02/16			DAN1135	14	210
435 xi	Petrol	225/250	N55 B30 A	MTM	07/14-02/16			DAN1137	14	210

									
BMW continued									
5 (F10, F11) (10-16)									
518 d	Diesel	100/110/120	B47 D20 A		07/13-02/17		DAN1464	14	180
518 d	Diesel	100/110/120	B47 D20 A		07/13-02/17		DAN1469	14	210
520 d	Diesel	120/140/155	B47 D20 A		06/10-02/17		DAN1464	14	180
520 d	Diesel	120/140/155	B47 D20 A		06/10-02/17		DAN1469	14	210
520 i 1.6	Petrol	125	N20 B16 A		07/13-10/16		DAN1126	14	170
520 i 1.6	Petrol	125	N20 B16 A		07/13-10/16		DAN1127	14	210
520 i 2.0	Petrol	120/135	N20 B20 A;N20 B20 B		10/10-02/17		DAN1126	14	170
520 i 2.0	Petrol	120/135	N20 B20 A;N20 B20 B		10/10-02/17		DAN1127	14	210
520 xd	Diesel	120/140/155	B47 D20 A		10/13-02/17		DAN1469	14	210
528 i 2.0	Petrol	180	N20 B20 A		09/11-02/17		DAN1126	14	170
528 i 2.0	Petrol	180	N20 B20 A		09/11-02/17		DAN1127	14	210
528 xi	Petrol	180	N20 B20 A		09/11-02/17		DAN1126	14	170
528 xi	Petrol	180	N20 B20 A		09/11-02/17		DAN1127	14	210
535 i	Petrol	225/240	N55 B30 A	ATM	03/12-02/17		DAN1135	14	210
535 i	Petrol	225/240	N55 B30 A	MTM	07/12-02/17		DAN1137	14	210
535 xi	Petrol	225/240	N55 B30 A	ATM	03/12-02/17		DAN1135	14	210
550 i	Petrol	330	N63 B44 B		07/13-02/17		DAN1138	14	210
550 xi	Petrol	330	N63 B44 B		07/13-10/16		DAN1138	14	210
M5 4.4	Petrol	412	S63 B44 B		09/11-10/16		DAN1138	14	210
M5 4.4 Competition	Petrol	423	S63 B44 B		02/13-10/16		DAN1138	14	210
M5 4.4 Edition 30	Petrol	441	S63 B44 B		07/14-10/16		DAN1138	14	210
5 Gran Turismo (F07) (09-17)									
528 i	Petrol	180	N20 B20 A		07/13-02/17		DAN1127	14	210
535 i	Petrol	225	N55 B30 A		03/12-02/17		DAN1135	14	210
535 xi	Petrol	225	N55 B30 A		03/12-02/17		DAN1135	14	210
550 i	Petrol	330	N63 B44 A;N63 B44 B		07/12-02/17		DAN1138	14	210
550 xi	Petrol	330	N63 B44 B		07/12-02/17		DAN1138	14	210
6 Coupe/Convertible (F12, F13) (10-18)									
640 i	Petrol	235	N55 B30 A		03/12-06/18		DAN1135	14	210
640 xi	Petrol	235	N55 B30 A		03/13-06/18		DAN1135	14	210
650 i	Petrol	330	N63 B44 B		07/12-06/18		DAN1138	14	210
650 xi	Petrol	330	N63 B44 B		07/12-06/18		DAN1138	14	210
M6 4.4	Petrol	412	S63 B44 B		03/12-06/18		DAN1138	14	210
M6 4.4 Competition	Petrol	423/441	S63 B44 B		07/13-06/18		DAN1138	14	210
6 Gran Coupe (F06) (11-18)									
640 i	Petrol	235	N55 B30 A	ATM	03/12-10/18		DAN1135	14	210
640 xi	Petrol	235	N55 B30 A	ATM	03/13-10/18		DAN1135	14	210
650 i	Petrol	330	N63 B44 B		07/12-10/18		DAN1138	14	210
650 xi	Petrol	330	N63 B44 B		07/12-10/18		DAN1138	14	210
M6 4.4	Petrol	412	S63 B44 B		03/13-10/18		DAN1138	14	210
M6 4.4 Competition	Petrol	423/441	S63 B44 B		07/13-10/18		DAN1138	14	210
7 (F01, F02, F03, F04) (08-15)									
740 i	Petrol	235	N55 B30 A	ATM	07/12-12/15		DAN1135	14	210
740 xi	Petrol	235	N55 B30 A	ATM	07/12-12/15		DAN1135	14	210
750 i, Li	Petrol	330	N63 B44 B		07/12-06/15		DAN1138	14	210
750 xi	Petrol	300/330	N63 B44 B		09/09-06/15		DAN1138	14	210
X1 (E84) (09-15)									
16 i	Petrol	105	N20 B16 A		03/13-06/15		DAN1126	14	170
16 i	Petrol	105	N20 B16 A		03/13-06/15		DAN1127	14	210
20 i	Petrol	135	N20 B20 A		09/11-06/15		DAN1126	14	170
20 i	Petrol	135	N20 B20 A		09/11-06/15		DAN1127	14	210
20 xi	Petrol	135	N20 B20 A		09/11-06/15		DAN1126	14	170
20 xi	Petrol	135	N20 B20 A		09/11-06/15		DAN1127	14	210
28 xi 2.0	Petrol	180	N20 B20 A		03/11-06/15		DAN1126	14	170
28 xi 2.0	Petrol	180	N20 B20 A		03/11-06/15		DAN1127	14	210
X1 (F48) (15-)									
16 d	Diesel	85	B37 C15 A		11/14-		DAN1464	14	180
18 d	Diesel	100/110	B47 C20 A;B47 C20 B		07/15-		DAN1464	14	180
18 i	Petrol	100/103	B38 A15 A		11/15-		DAN1464	14	180
18 xd	Diesel	100/110	B47 C20 A;B47 C20 B		11/14-		DAN1464	14	180
20 d	Diesel	120/140	B47 C20 A;B47 C20 B		11/15-		DAN1464	14	180
20 i	Petrol	141	B42 S20 A;B48 A20 A; B48 A20 F		07/15-		DAN1464	14	180

									
BMW continued									
X1 (F48) (15-) continued									
20 xd	Diesel	120/140	B47 C20 A;B47 C20 B		07/15-		DAN1464	14	180
20 xi	Petrol	141	B48 A20 A;B48 A20 B; B48 A20 F		07/15-		DAN1464	14	180
25 xd	Diesel	170	B47 C20 B		11/14-		DAN1464	14	180
25 xi	Petrol	170	B42 S20 A;B46 A20 B; B48 A20 B		07/15-		DAN1464	14	180
X2 (F39) (17-)									
18 d	Diesel	100/110	B47 C20 A		03/18-		DAN1464	14	180
18 i	Petrol	100	B32 S15 A		03/18-		DAN1464	14	180
20 d	Diesel	120/140	B47 C20 A		11/18-		DAN1464	14	180
20 i	Petrol	141	B42 S20 A		11/17-		DAN1464	14	180
20 xd	Diesel	120/140	B47 C20 A		11/17-		DAN1464	14	180
25 xd	Diesel	170	B47 C20 B		11/17-		DAN1464	14	180
X3 (F25) (10-17)									
18 d	Diesel	110	B47 D20 A		04/14-08/17		DAN1464	14	180
18 d	Diesel	110	B47 D20 A		04/14-08/17		DAN1469	14	210
20 i 1.6	Petrol	125	N20 B16 A		04/14-08/17		DAN1126	14	170
20 i 1.6	Petrol	125	N20 B16 A		04/14-08/17		DAN1127	14	210
20 i 2.0	Petrol	135	N20 B20 A		04/14-08/17		DAN1126	14	170
20 i 2.0	Petrol	135	N20 B20 A		04/14-08/17		DAN1127	14	210
20 xd	Diesel	140	B47 D20 A		04/14-08/17		DAN1464	14	180
20 xd	Diesel	140	B47 D20 A		04/14-08/17		DAN1469	14	210
20 xi	Petrol	135	N20 B20 A		10/11-08/17		DAN1126	14	170
20 xi	Petrol	135	N20 B20 A		10/11-08/17		DAN1127	14	210
28 xi 2.0	Petrol	180	N20 B20 A		04/12-08/17		DAN1126	14	170
28 xi 2.0	Petrol	180	N20 B20 A		04/12-08/17		DAN1127	14	210
35 xi	Petrol	225	N55 B30 A		03/12-08/17		DAN1135	14	210
X4 (F26) (14-18)									
20 xd	Diesel	120/140	B47 D20 A		04/14-03/18		DAN1464	14	180
20 xd	Diesel	120/140	B47 D20 A		04/14-03/18		DAN1469	14	210
20 xi	Petrol	135	N20 B20 A		04/14-03/18		DAN1127	14	210
28 xi	Petrol	180	N20 B20 A		04/14-03/18		DAN1127	14	210
35 xi	Petrol	225	N55 B30 A		04/14-03/18		DAN1135	14	210
M 40 i	Petrol	265	N55 B30 A		12/15-03/18		DAN1135	14	210
X5 (E70) (07-13)									
35 xi	Petrol	225/235	N55 B30 A	ATM	03/12-07/13		DAN1135	14	210
40 xi	Petrol	225	N55 B30 A	ATM	03/12-06/13		DAN1135	14	210
X5 (F15) (12-18)									
25 d	Diesel	170	B47 D20 B		08/15-07/18		DAN1469	14	210
25 xd 2.0	Diesel	170	B47 D20 B		08/15-07/18		DAN1469	14	210
35 xi	Petrol	225/240	N55 B30 A	ATM	12/13-07/18		DAN1135	14	210
50 xi	Petrol	330	N63 B44 B		08/13-07/18		DAN1138	14	210
M 4.4	Petrol	423	S63 B44 B		12/14-07/18		DAN1138	14	210
X6 (E71, E72) (08-14)									
35 xi	Petrol	235	N55 B30 A	ATM	03/12-06/14		DAN1135	14	210
X6 (F16) (14-19)									
35 xi	Petrol	225/240	N55 B30 A	ATM	08/14-07/19		DAN1135	14	210
50 xi	Petrol	330	N63 B44 B		08/14-07/19		DAN1138	14	210
M 4.4	Petrol	423	S63 B44 B		12/14-07/19		DAN1138	14	210
Z4 (E89) (09-16)									
18 i	Petrol	115	N20 B20 A		04/13-08/16		DAN1126	14	170
18 i	Petrol	115	N20 B20 A		04/13-08/16		DAN1127	14	210
20 i	Petrol	120/135	N20 B20 A		09/11-08/16		DAN1126	14	170
20 i	Petrol	120/135	N20 B20 A		09/11-08/16		DAN1127	14	210
28 i	Petrol	180	N20 B20 A		09/11-08/16		DAN1126	14	170
28 i	Petrol	180	N20 B20 A		09/11-08/16		DAN1127	14	210
CADILLAC									
BLS (06-)									
1.9 D	Diesel	110/132	Z 19 DTH;Z 19 DTR		04/06-		DAN1009	14	130
CHRYSLER									
YPSILON (846) (11-)									
0.9 Twinair	Petrol	63	312 A2.000		05/11-		DAN1078	14	120
CITROËN									
BERLINGO (B9) (08-)									
1.2 PureTech 110	Petrol	81	HNZ (EB2DT)		02/16-		DAN1325	14	150
1.6	Petrol	66/80	NFR (TU5JP4B); NFU (TU5JP4)		04/08-		DAN1336	14	90

									
CITROËN continued									
BERLINGO (MF) (96-11)									
1.1 i	Petrol	44	HDZ (TU1M); HFX (TU1JP)		07/96-10/02	+ LS	DAN1063	14	80
1.1 i	Petrol	44	HFX (TU1JP)		11/02-05/08		DAN1336	14	90
1.4	Petrol	53	KFW (TU3JP)		11/02-10/05		DAN1336	14	90
1.4 bivalent	Petrol/ Compressed Natural Gas (CNG)	48	KFW (TU3JP)		11/02-12/11		DAN1336	14	90
1.4 i	Petrol	55	KFW (TU3A); KFW (TU3JP); KFX (TU3JP)		07/96-10/02	+ LS	DAN1063	14	80
1.4 i	Petrol	55	KFW (TU3JP)		11/02-12/11		DAN1336	14	90
1.4 i bivalent	Petrol/ Compressed Natural Gas (CNG)	55	KFW (TU3JP)		04/03-10/08		DAN1336	14	90
1.6 16V	Petrol	80	NFU (TU5JP4)		10/00-10/02		DAN1063	14	80
1.6 16V	Petrol	80	NFU (TU5JP4)		11/02-12/11		DAN1336	14	90
1.9 D	Diesel	51	WJY (DW8B)		11/02-10/05		DAN1336	14	90
1.9 D 4WD	Diesel	51	WJY (DW8B)		11/02-10/05		DAN1336	14	90
1.9 D 70	Diesel	51	WJY (DW8B)		11/02-12/11		DAN1336	14	90
1.9 D 70 4WD	Diesel	51	WJY (DW8B)		11/02-03/06		DAN1336	14	90
C1 I (05-14)									
1.0	Petrol	50	CFB (1KR)		06/05-09/14		DAN1035	14	70
1.0	Petrol	50	CFB (1KR)		06/05-09/14	+ Co;+ Ho	DAN1036	14	80
C2 (03-10)									
1.1	Petrol	44	HFX (TU1A); HFX (TU1JP)		09/03-09/12		DAN515	14	90
1.4	Petrol	54	KFV (TU3A); KFV (TU3JP)		09/03-12/09		DAN515	14	90
1.6	Petrol	80	NFU (TU5JP4)		07/03-10/10		DAN515	14	90
1.6 VTS	Petrol	90	NFS (TU5JP4S)		10/04-12/09		DAN515	14	90
C3 Aircross (17-)									
1.2 PureTech 110	Petrol	81	HNP (EB2ADT); HNV (EB2DTM); HNZ (EB2DT)		06/17-		DAN1325	14	150
1.2 PureTech 130	Petrol	96	HNS (EB2ADTS); HNY (EB2DTS)		07/17-		DAN1325	14	150
1.2 PureTech 82	Petrol	60	HMR (EB2FA); HMZ (EB2F)		06/17-		DAN1325	14	150
C3 I (02-)									
1.1 i	Petrol	44	HFX (TU1A); HFX (TU1JP)		02/02-		DAN515	14	90
1.4 16V	Petrol	65	KFU (ET3J4)		12/03-		DAN515	14	90
1.4 i	Petrol	54	KFV (TU3JP)		02/02-11/10		DAN515	14	90
1.4 i Bivalent	Petrol/ Compressed Natural Gas (CNG)	54	KFV (TU3JP)		02/02-		DAN515	14	90
1.6 16V	Petrol	80	NFU (TU5JP4)		02/02-08/10		DAN515	14	90
C3 II (09-)									
1.0 VTi 68	Petrol	50	EB0		08/12-		DAN1071	14	90
1.2 THP 110	Petrol	81	EB2DT		10/14-		DAN1071	14	90
1.2 VTi 82	Petrol	60	EB2;EB2F		06/12-09/16		DAN1071	14	90
C3 Picasso (09-)									
1.2 THP 110	Petrol	81	EB2DT		01/15-		DAN1071	14	90
C3 Pluriel (03-)									
1.4	Petrol	54	KFV (TU3A); KFV (TU3JP)		05/03-		DAN515	14	90
1.6	Petrol	80	NFU (TU5JP4)		05/03-		DAN515	14	90
C4 (Grand) Picasso II (13-)									
1.2 THP 110	Petrol	81	HNZ (EB2DT)		04/16-		DAN1325	14	150
1.2 THP 130	Petrol	96	EB2DTS		04/14-		DAN1325	14	150
C4 Cactus (14-)									
1.2 THP 110	Petrol	81	EB2DT		09/14-		DAN1071	14	90
1.2 THP 110	Petrol	81	EB2DT		09/14-		DAN1325	14	150











									
CITROËN continued									
C4 Cactus (14-) continued									
1.2 VTi / PureTech 75	Petrol	55	EB2D;EB2FD		09/14-		DAN1071	14	90
1.2 VTi 82	Petrol	60	EB2;EB2F		09/14-		DAN1071	14	90
C4 Coupe (04-11)									
1.4 16V	Petrol	65	KFU (ET3J4)		11/04-07/11		DAN515	14	90
1.6 16V	Petrol	80	NFU (TU5JP4)		11/04-07/11		DAN515	14	90
2.0 16V	Petrol	100	RFN (EW10J4)		11/04-07/07		DAN1336	14	90
C4 I (LC, LR) (04-11)									
1.4 16V	Petrol	65	KFU (ET3J4)		11/04-07/11		DAN515	14	90
1.6 16V	Petrol	80	NFU (TU5JP4)		11/04-07/11		DAN515	14	90
1.6 16V Bio-Flex	Flexfuel	80	NFU (TU5JP4)		09/07-07/08		DAN515	14	90
2.0 16V	Petrol	100	RFN (EW10J4)		11/04-07/07		DAN1336	14	90
C4 II (B7, NC) (09-)									
1.2 THP 110	Petrol	81	HNZ (EB2DT)		02/15-12/18		DAN1071	14	90
1.2 THP 130	Petrol	96	EB2DTS		04/14-		DAN1071	14	90
1.2 THP 130	Petrol	96	EB2DTS		04/14-		DAN1325	14	150
C5 I (01-04)									
1.8 16V	Petrol	85	6FZ (EW7J4)		03/01-08/04	+ LS	DAN1336	14	90
2.0 16V	Petrol	100	RFN (EW10J4)		03/01-08/04	+ LS	DAN1336	14	90
2.0 16V HPi	Petrol	103	RLZ (EW10D)		03/01-08/04	+ LS	DAN1336	14	90
C5 II (04-)									
1.8 16V	Petrol	85	6FZ (EW7J4)		09/04-		DAN1336	14	90
C8 (02-)									
2.0	Petrol	100	RFN (EW10J4)		07/02-		DAN1336	14	90
2.2	Petrol	116	3FZ (EW12J4)		07/02-		DAN1336	14	90
C15 (84-05)									
1.9 D	Diesel	44	WJX (DW8B)		01/03-12/05	+ LS	DAN1336	14	90
C-ELYSEE (12-)									
1.2 VTi 72	Petrol	53	EB2 M		11/12-		DAN1071	14	90
1.2 VTi 72	Petrol	53	EB2 M		11/12-		DAN1325	14	150
1.2 VTi 82	Petrol	60	HMZ (EB2); HMZ (EB2F)		12/14-12/18		DAN1071	14	90
1.6 VTi 115	Petrol	85	NFP (EC5)		11/12-		DAN515	14	90
DS3 (09-15)									
1.2 THP 110	Petrol	81	EB2DT		10/14-07/15		DAN1071	14	90
1.2 VTi 82	Petrol	60	EB2;EB2F		01/13-07/15		DAN1071	14	90
DS4 (11-15)									
1.2 THP 130	Petrol	96	EB2DTS		07/14-07/15		DAN1071	14	90
1.2 THP 130	Petrol	96	EB2DTS		07/14-07/15		DAN1325	14	150
JUMPY (95-06)									
1.9 D 70	Diesel	51	WJY (DW8B)		09/01-10/06	+ LS	DAN1336	14	90
2.0	Petrol	100	RFN (EW10J4)		04/00-12/06	+ LS	DAN1336	14	90
NEMO (08-)									
1.3 BlueHdi 80	Diesel	59	FHY (F13DTE6)		02/16-	+ SS	DAN997	14	120
1.3 Hdi 75	Diesel	55	FHZ (F13DTE5)		10/10-	- AC	DAN1001	14	105
1.3 Hdi 75	Diesel	55	FHZ (F13DTE5)		10/10-	+ AC	DAN997	14	120
1.3 Hdi 75	Diesel	55	FHZ (F13DTE5)		10/10-	+ AC;ECO KIT	DAN1086	14	120
1.3 Hdi 80	Diesel	59	FHY (F13DTE6)		10/15-	+ SS	DAN997	14	120
1.4	Petrol	54	KFT (TU3A); KFV (TU3A)		02/08-		DAN1336	14	90
SAXO (96-04)									
1.0 X	Petrol	33/37	CDY (TU9M); CDZ (TU9M)		05/96-06/03	+ LS	DAN1063	14	80
1.1 X,SX	Petrol	40/44	HDZ (TU1M); HFX (TU1JP)		05/96-09/03	+ LS	DAN1063	14	80
1.4 VTS	Petrol	55	KFW (TU3JP); KFX (TU3JP)		05/96-06/03	+ LS	DAN1063	14	80
1.6	Petrol	66/74/88	NFT (TU5JP); NFX (TU5JP4); NFZ (TU5JP)		02/96-04/04	+ LS	DAN1063	14	80
1.6 VTL,VTR	Petrol	65	NFZ (TU5JP)		05/96-06/03	+ LS	DAN1063	14	80
1.6 VTS	Petrol	72/87	NFT (TU5JP); NFX (TU5JP4)		06/96-09/03	+ LS	DAN1063	14	80
XSARA (97-05)									
1.4 i	Petrol	55	KFW (TU3JP)		09/00-08/05		DAN1336	14	90
1.6 16V	Petrol	80	NFU (TU5JP4)		09/00-08/05		DAN1336	14	90
1.9 D	Diesel	51	WJY (DW8B)		10/02-08/05		DAN1336	14	90
XSARA Picasso (99-11)									
1.6	Petrol	65	NFZ (TU5JP)		12/99-09/01	+ LS	DAN1336	14	90
1.6	Petrol	70	NFV (TU5JP)		12/99-12/10		DAN1336	14	90
1.6 16V	Petrol	80	NFU (TU5JP4)		09/05-12/11		DAN1336	14	90











									
CITROËN continued									
XSARA Picasso (99-11) continued									
1.8 16V	Petrol	85	6FZ (EW7J4)		05/00-08/05		DAN1336	14	90
2.0 16V	Petrol	100	RFN (EW10J4)		01/03-06/12		DAN1336	14	90
DAIHATSU									
APPLAUSE I (89-97)									
1.6 16V	Petrol	77	HD-E		06/89-07/97		DAN969	14	60
1.6 16V 4WD	Petrol	77	HD-E		06/89-07/97		DAN969	14	60
APPLAUSE II (97-00)									
1.6 16V	Petrol	73	HD-E		07/97-05/00		DAN969	14	60
CHARADE IV (93-00)									
1.3	Petrol	44	HC		09/96-11/99		DAN971	14	60
1.3	Petrol	44	HC		09/96-11/99		DAN970	14	70
1.3	Petrol	44	HC		09/96-11/99		DAN972	14	70
1.3 16V	Petrol	55	HC-E		05/96-11/99		DAN971	14	60
1.3 16V	Petrol	55	HC-E		05/96-11/99		DAN970	14	70
1.3 16V	Petrol	55	HC-E		05/96-11/99		DAN972	14	70
1.3 i 16V	Petrol	62	HC;HC-E		01/93-09/00		DAN971	14	60
1.3 i 16V	Petrol	62	HC;HC-E		01/93-09/00		DAN970	14	70
1.3 i 16V	Petrol	62	HC;HC-E		01/93-09/00		DAN972	14	70
1.5 16V	Petrol	55	HEE		10/94-01/01		DAN971	14	60
1.5 16V	Petrol	55	HEE		10/94-01/01		DAN970	14	70
1.5 16V	Petrol	55	HEE		10/94-01/01		DAN972	14	70
1.5 i 16V	Petrol	66	HEE;HEEG		06/94-11/99		DAN971	14	60
1.5 i 16V	Petrol	66	HEE;HEEG		06/94-11/99		DAN970	14	70
1.5 i 16V	Petrol	66	HEE;HEEG		06/94-11/99		DAN972	14	70
COPEN (03-12)									
0.7	Petrol	50	JB;JB-DET		09/03-12/07		DAN975	14	65
CUORE VI (03-)									
1.0	Petrol	43	EJ-VE		05/03-		DAN973	14	60
EXTOL (00-)									
1.3	Petrol	63	K3-VE		06/04-11/11		DAN978	14	70
FEROZA (88-99)									
1.6 16V	Petrol	63	HD-C		10/88-12/99		DAN969	14	60
1.6 16V 4x4	Petrol	62	HD-C		10/88-12/99		DAN969	14	60
1.6 i 16V	Petrol	70	HD-E		10/88-12/99		DAN969	14	60
1.6 i 16V 4x4	Petrol	70	HD-E		10/88-12/99		DAN969	14	60
GRAN MOVE (96-02)									
1.5 16V	Petrol	66	HEEG		10/96-07/98		DAN971	14	60
1.5 16V	Petrol	66	HEEG		10/96-07/98		DAN970	14	70
1.5 16V	Petrol	66	HEEG		10/96-07/98		DAN972	14	70
1.6 16V	Petrol	67	HD-EP		05/98-07/02		DAN971	14	60
1.6 16V	Petrol	67	HD-EP		05/98-07/02		DAN970	14	70
1.6 16V	Petrol	67	HD-EP		05/98-07/02		DAN972	14	70
HIJET (86-90)									
0.8	Petrol	29	CD		06/86-12/89		DAN968	14	40
1.0	Petrol	33	CB		06/86-12/89		DAN968	14	40
1.0 4x4	Petrol	33	CB 10		07/86-10/90		DAN968	14	40
HIJET (92-)									
1.0	Petrol	34	CB41		12/92-05/98		DAN968	14	40
MATERIA (06-)									
1.3	Petrol	67	K3-VE		10/06-		DAN980	14	80
1.5	Petrol	76	3SZ-VE		10/06-		DAN979	14	80
1.5 ECO 4WD	Petrol	76	3SZ-VE		10/06-		DAN979	14	80
1.5 LPG	Petrol/ Liquified Petroleum Gas (LPG)	76	3SZ-VE		01/10-12/11		DAN979	14	80
MOVE (94-02)									
1.0 i	Petrol	41	EJ-DE		10/98-09/02		DAN973	14	60
1.0 i	Petrol	41	EJ-DE		10/98-09/02		DAN974	14	60
SIRION (98-05)									
1.0	Petrol	40	EJ-DE		04/98-10/00		DAN973	14	60
1.0	Petrol	40	EJ-DE		04/98-10/00		DAN974	14	60
1.0 i	Petrol	41	EJ-DE		04/98-09/00		DAN974	14	60
1.0 i	Petrol	41/43	EJ-DE;EJ-VE		04/98-01/05		DAN973	14	60
1.0 i 4WD	Petrol	41	EJ-DE		04/99-09/00		DAN974	14	60
1.0 i 4WD	Petrol	41/43	EJ-DE;EJ-VE		04/99-01/05		DAN973	14	60
1.3 Sport	Petrol	75	K3-VE2		08/00-01/05		DAN976	14	70













A

DAIHATSU continued									
SIRION (98-05) continued									
1.3 Sport 4WD	Petrol	75	K3-VE2		08/00-03/05		DAN976	14	70
SIRION (05-)									
1.3	Petrol	64/67	K3-VE		01/05-		DAN980	14	80
1.3 4WD	Petrol	64/67	K3-VE		04/05-		DAN980	14	80
1.5	Petrol	76	3SZ-VE		03/08-		DAN979	14	80
TERIOS (97-05)									
1.3	Petrol	63	K3-VE		07/00-10/06		DAN976	14	70
1.3 4WD	Petrol	63	K3-VE		10/00-10/05		DAN976	14	70
TERIOS (05-)									
1.3 VVT-i 4x4	Petrol	63	K3-VE		11/05-		DAN980	14	80
1.5 4x4	Petrol	77	3SZ-VE		05/06-		DAN979	14	80
1.5 LPG 4x4	Petrol/ Liquified Petroleum Gas (LPG)	77	3SZ-VE		06/09-		DAN979	14	80
1.5 VVT-i 4x4	Petrol	75	3SZ-VE		09/10-		DAN979	14	80
1.5 VVT-i RWD	Petrol	75/77	3SZ-VE		01/06-		DAN979	14	80
TREVIS (06-)									
1.0	Petrol	43	EJ-VE		06/06-		DAN973	14	60
YRV (01-)									
1.0	Petrol	43	EJ-VE		02/01-		DAN973	14	60
1.3	Petrol	64	K3-VE		02/01-		DAN976	14	70
1.3 4WD	Petrol	64	K3-VE		02/01-		DAN976	14	70
1.3 GTti	Petrol	95	K3-VET		07/02-		DAN976	14	70
DS									
DS3 (15-19)									
1.2 THP 110	Petrol	81	HNP (EB2ADT); HNZ (EB2DT)		07/15-07/19		DAN1071	14	90
1.2 THP 110 / PureTech 110	Petrol	81	HNP (EB2ADT); HNZ (EB2DT)		04/15-07/19		DAN1071	14	90
1.2 THP 130	Petrol	96	HNY (EB2DTS)		09/15-07/19		DAN1071	14	90
1.2 VTI 82	Petrol	60	HMZ (EB2); HMZ (EB2F)		04/15-07/19		DAN1071	14	90
DS4 (Crossback) (15-18)									
1.2 THP 130	Petrol	96	HNY (EB2DTS)		07/15-12/18		DAN1071	14	90
FIAT									
124 Spider (348) (16-)									
1.4	Petrol	103	552 53 268		03/16-		DAN1332	14	150
500 (C) (312) (07-)									
0.9	Petrol	44/48	312 A4.000;312 A6.000		09/12-		DAN993	14	120
0.9 TwinAir	Petrol	59/63/77	199 B6.000;312 A2.000; 312 A5.000		09/09-		DAN993	14	120
0.9 TwinAir	Petrol	59/63/77	199 B6.000;312 A2.000; 312 A5.000		09/09-	TECH B	DAN1078	14	120
1.2	Petrol	51	169 A4.000		07/07-	- SS;- AC	DAN998	14	70
1.2	Petrol	51	169 A4.000		07/07-	- SS;- AC;+ Co	DAN1004	14	90
1.2	Petrol	51	169 A4.000		07/07-	- SS;+ AC	DAN519	14	90
1.2	Petrol	51	169 A4.000		07/07-	- SS;+ AC;+ Co;+ Ho	DAN599	14	105
1.2	Petrol	51	169 A4.000		07/07-	+ SS;- AC	DAN1005	14	105
1.2	Petrol	51	169 A4.000		07/07-	+ SS;+ AC	DAN999	14	120
1.2 LPG	Petrol/ Liquified Petroleum Gas (LPG)	51	169 A4.000		12/10-		DAN517	14	70
1.3 D Multijet	Diesel	55	169 A1.000		10/07-	- AC	DAN1003	14	70
1.3 D Multijet	Diesel	55	169 A1.000		10/07-	- AC;+ Co;+ Ho	DAN1001	14	105
1.3 D Multijet	Diesel	55	169 A1.000		10/07-	+ AC	DAN1002	14	90
1.3 D Multijet	Diesel	55	169 A1.000		10/07-	+ AC;+ Co;+ Ho	DAN997	14	120
1.3 D Multijet	Diesel	57	312 B5.000		06/16-		DAN1086	14	120
1.3 D Multijet	Diesel	70	199 B1.000;312 B1.000		09/09-	- AC	DAN1001	14	105
1.3 D Multijet	Diesel	70	199 B1.000;312 B1.000		09/09-	+ AC	DAN997	14	120
1.3 D Multijet	Diesel	70	199 B1.000;312 B1.000		09/09-	+ AC;ECO KIT	DAN1086	14	120
1.4	Petrol	74	169 A3.000		10/07-	- SS;- AC	DAN998	14	70
1.4	Petrol	74	169 A3.000		10/07-	- SS;- AC;+ Co	DAN1004	14	90
1.4	Petrol	74	169 A3.000		10/07-	- SS;+ AC	DAN519	14	90
1.4	Petrol	74	169 A3.000		10/07-	- SS;+ AC;+ Co;+ Ho	DAN599	14	105
1.4	Petrol	74	169 A3.000		10/07-	+ SS;- AC	DAN1005	14	105

         										
FIAT continued										
500 (C) (312) (07-) continued										
1.4	Petrol	74	169 A3.000		10/07-	+ SS;+ AC	DAN999	14	120	
500L (12-)										
0.9 Natural Power	Petrol/ Compressed Natural Gas (CNG)	59	312 A2.000		04/17-	+ SS	DAN1078	14	120	
0.9 Natural Power	Petrol/ Compressed Natural Gas (CNG)	63	312 A2.000		03/13-		DAN993	14	120	
0.9 TwinAir	Petrol	77	199 B6.000		09/12-	+ SS	DAN1078	14	120	
0.9 TwinAir	Petrol	77	199 B6.000		09/12-	+ SS;+ Co;+ Ho	DAN1089	14	120	
1.3 D Multijet	Diesel	62	199 B4.000		09/12-05/14	+ AC	DAN1086	14	120	
1.3 D Multijet	Diesel	62	199 B4.000		05/14-	+ AC	DAN1310	14	120	
1.3 D Multijet	Diesel	70	330 A1.000		06/14-		DAN1086	14	120	
1.3 D Multijet	Diesel	70	330 A1.000		06/14-	+ Co;+ Ho	DAN1310	14	120	
1.4	Petrol	70	843 A1.000		09/12-	- AC	DAN998	14	70	
1.4	Petrol	70	843 A1.000		09/12-	+ AC	DAN599	14	105	
1.4	Petrol	88	940 B7.000		10/13-	+ AC	DAN993	14	120	
1.4 LPG	Petrol/ Liquefied Petroleum Gas (LPG)	88	940 B7.000		02/14-10/15		DAN993	14	120	
1.6 D Multijet	Diesel	77	199 B5.000		09/12-05/18	+ AC;+ Co;+ Ho	DAN1145	14	150	
1.6 D Multijet	Diesel	77/88	199 B5.000;552 80 444; 940 C1.000;955 A3.000		09/12-	-/+ AC	DAN1121	14	120	
1.6 D Multijet	Diesel	88	940 C1.000;955 A3.000; 552 80 444		09/13-	-/+ AC;+ Co;+ Ho	DAN1146	14	150	
500X (14-)										
1.3 D Multijet	Diesel	70	552 66 963;552 83 775		11/14-06/15		DAN1086	14	120	
1.3 D Multijet	Diesel	70	552 66 963;552 83 775		06/15-		DAN1310	14	120	
1.4	Petrol	103	552 63 624		09/14-		DAN1078	14	120	
1.4	Petrol	103	552 63 624		09/14-	+ Co;+ Ho	DAN1332	14	150	
1.4 4x4	Petrol	125	552 63 623		02/15-		DAN1332	14	150	
1.6 D Multijet	Diesel	84/88	552 60 384;552 80 444		09/14-		DAN1121	14	120	
1.6 D Multijet	Diesel	84/88	552 60 384;552 80 444		09/14-	+ Co;+ Ho	DAN1146	14	150	
2.0 D Multijet 4x4	Diesel	100/103	552 63 087;552 63 088; 552 83 099		09/14-		DAN1121	14	120	
2.0 D Multijet 4x4	Diesel	100/103	552 63 087;552 63 088; 552 83 099		09/14-	+ Co;+ Ho	DAN1146	14	150	
ALBEA / SIENA (96-11)										
1.2	Petrol	44	178 C4.066;188 A4.000		09/01-02/05	+ AC;M8	DAN629	14	90	
1.2	Petrol	54	178 B5.000		09/98-12/02	+ AC;+ PS	DAN629	14	90	
1.2	Petrol	59	188 A5.000	ATM	09/01-12/09	+ AC	DAN599	14	105	
1.2	Petrol	59	188 A5.000	MTM	09/01-12/09	+ AC	DAN517	14	70	
1.3 JTD	Diesel	51	188 A9.000		09/03-12/09	- AC	DAN1003	14	70	
1.3 JTD	Diesel	51	188 A9.000		09/03-12/09	+ AC	DAN1002	14	90	
1.4	Petrol	57	178 F3.011;350 A1.000		01/07-12/09	- AC	DAN998	14	70	
1.4	Petrol	57	178 F3.011;350 A1.000		01/07-12/09	+ AC	DAN517	14	70	
1.4	Petrol	57	178 F3.011;350 A1.000		01/07-12/09	+ AC;CIS	DAN599	14	105	
BARCETTA (95-05)										
1.8 16V	Petrol	96	183 A1.000		08/95-05/05	+ AC	DAN1140	14	105	
1.8 16V	Petrol	96	183 A1.000;188 A6.000		08/95-05/05	+ AC	DAN1037	14	90	
1.8 16V	Petrol	96	188 A6.000		04/95-05/05	Eng No: >2988825;+ AC	DAN1140	14	105	
BRAVA (95-02)										
1.2 16V 80	Petrol	59	182 B2.000		12/98-12/02	+ AC	DAN629	14	90	
1.2 16V 80	Petrol	59	188 A5.000		10/00-10/01	+ AC	DAN519	14	90	
1.4 12 V	Petrol	59	182 A3.000	MTM	10/95-08/98	+ PS	DAN1037	14	90	
1.8 GT 16V	Petrol	83	182 A2.000		10/95-08/01		DAN1037	14	90	
1.9 D	Diesel	48	160 A7.000		10/95-10/98	+ AC	DAN628	14	85	
1.9 JTD	Diesel	74	182 B9.000		09/00-10/01	- AC	DAN501	14	105	
1.9 JTD	Diesel	74	182 B9.000		09/00-10/01	+ AC	DAN502	14	120	
1.9 JTD 105	Diesel	77	182 B4.000		12/98-10/01	Eng No: >1199498;+ AC	DAN1140	14	105	
1.9 JTD 105	Diesel	77	182 B4.000		12/98-10/01	Eng No: >1258938; 1270131;- AC	DAN1037	14	90	











         									
FIAT continued									
BRAVA (95-02) continued									
1.9 JTD 105	Diesel	77	182 B4.000		12/98-10/01	Eng No: 1199498>1719251; + AC	DAN501	14	105
1.9 JTD 105	Diesel	77	182 B4.000		12/98-10/01	Eng No: 1258938; 1270131>;- AC	DAN501	14	105
1.9 JTD 105	Diesel	77	182 B4.000		12/98-10/01	Eng No: 1719251>;+ AC	DAN502	14	120
BRAVO I (95-01)									
1.2 16V 80	Petrol	59	182 B2.000		12/98-10/00	+ AC	DAN629	14	90
1.2 16V 80	Petrol	59	188 A5.000		10/00-10/01	+ AC	DAN519	14	90
1.4	Petrol	55/59	182 A3.000;182 A5.000	MTM	10/95-08/98	+ PS	DAN1037	14	90
1.8 GT	Petrol	83	182 A2.000		10/95-10/01		DAN1037	14	90
1.9 D	Diesel	48	160 A7.000		10/95-10/98	+ AC	DAN628	14	85
1.9 JTD	Diesel	74	182 B9.000		09/00-10/01	- AC	DAN501	14	105
1.9 JTD	Diesel	74	182 B9.000		09/00-10/01	+ AC	DAN502	14	120
1.9 JTD 105	Diesel	77	182 B4.000		12/98-10/01	Eng No: >1199498;>+ AC	DAN1140	14	105
1.9 JTD 105	Diesel	77	182 B4.000		12/98-10/01	Eng No: >1258938; 1270131>;- AC	DAN1037	14	90
1.9 JTD 105	Diesel	77	182 B4.000		12/98-10/01	Eng No: 1199498>1719251; + AC	DAN501	14	105
1.9 JTD 105	Diesel	77	182 B4.000		12/98-10/01	Eng No: 1258938; 1270131>;- AC	DAN501	14	105
1.9 JTD 105	Diesel	77	182 B4.000		12/98-10/01	Eng No: 1719251>;+ AC	DAN502	14	120
BRAVO II (06-14)									
1.4	Petrol	66	192 B2.000		04/07-12/14	- AC	DAN998	14	70
1.4	Petrol	66	192 B2.000		04/07-12/14	- AC;>+ Co	DAN1005	14	105
1.4	Petrol	66	192 B2.000		04/07-12/14	+ AC	DAN519	14	90
1.4	Petrol	66	192 B2.000		04/07-12/14	+ AC;>+ Co	DAN599	14	105
1.4 16V	Petrol	103	198 A7.000		04/10-12/14	- AC	DAN998	14	70
1.4 16V	Petrol	103	198 A7.000		04/10-12/14	- AC;>+ Co	DAN1005	14	105
1.4 16V	Petrol	103	198 A7.000		04/10-12/14	+ AC	DAN519	14	90
1.4 16V	Petrol	103	198 A7.000		04/10-12/14	+ AC;>+ Co	DAN599	14	105
1.4 T-Jet	Petrol	88/110	198 A1.000;198 A4.000		09/07-12/14	- AC	DAN1005	14	105
1.4 T-Jet	Petrol	88/110	198 A1.000;198 A4.000		09/07-12/14	+ AC	DAN993	14	120
1.6 D Multijet	Diesel	66/77/88	198 A2.000;198 A3.000; 198 A6.000;844 A3.000		09/07-02/10	+ FDC	DAN1062	14	140
1.6 D Multijet	Diesel	66/77/88	198 A2.000;198 A3.000; 198 A6.000;844 A3.000		09/07-12/14		DAN994	14	100
1.6 D Multijet	Diesel	66/77/88	198 A2.000;198 A3.000; 198 A6.000;844 A3.000		09/07-12/14	+ Co	DAN995	14	120
1.6 D Multijet	Diesel	66/77/88	198 A2.000;198 A3.000; 198 A6.000;844 A3.000	AMT	02/10-12/14	+ AC	DAN1147	14	100
1.6 D Multijet	Diesel	66/77/88	198 A2.000;198 A3.000; 198 A6.000;844 A3.000	AMT	02/10-12/14	+ AC;>+ Co	DAN1084	14	120
1.9 D Multijet	Diesel	66/85/88	192 A1.000;192 A8.000; 192 B4.000;192 B5.000		11/06-12/14		DAN1365	14	90
1.9 D Multijet	Diesel	66/85/88	192 A1.000;192 A8.000; 192 B4.000;192 B5.000		11/06-12/14	+ Co	DAN502	14	120
1.9 D Multijet	Diesel	110	937 A5.000		04/07-12/14	Ch No: >4102283	DAN513	14	120
1.9 D Multijet	Diesel	110	937 A5.000		04/07-12/14	Ch No: 4102283>	DAN994	14	100
1.9 D Multijet	Diesel	110	937 A5.000		04/07-12/14	Ch No: 4102283>;>Police	DAN995	14	120
2.0 D Multijet	Diesel	121	198 A5.000;198 A8.000; 844 A2.000		09/08-12/09		DAN994	14	100
2.0 D Multijet	Diesel	121	198 A5.000;198 A8.000; 844 A2.000		05/09-12/09		DAN995	14	120
2.0 D Multijet	Diesel	121	198 A5.000;198 A8.000; 844 A2.000		12/09-12/14		DAN1147	14	100
2.0 D Multijet	Diesel	121	198 A5.000;198 A8.000; 844 A2.000		12/09-12/14		DAN1084	14	120
COUPE (93-00)									
1.8 16V	Petrol	96	183 A1.000		03/96-08/00		DAN1037	14	90
CROMA (85-96)									
1600	Petrol	61	154 A.048	MTM	08/86-12/90		DAN615	14	65
2000 CHT	Petrol	66	154 A1.000	MTM	08/86-02/89		DAN615	14	65
2000 CHT	Petrol	74	154 C5.000		03/91-09/92		DAN615	14	65
2000 i.e.	Petrol	85	154 C3.046;834 B.146	MTM	10/87-08/96		DAN615	14	65
2000 i.e.	Petrol	88	154 C3.000;834 B.000	MTM	03/87-09/92	Ch No: 0817137>0817136	DAN615	14	65
2000 i.e. Turbo	Petrol	110	154 C4.046;834 C.146	MTM	06/87-08/96		DAN615	14	65
2000 i.e. Turbo	Petrol	114	154 A2.000	MTM	12/85-06/90	Ch No: 0817137>0817136	DAN615	14	65

										
FIAT continued										
CROMA (05-)										
1.9 D Multijet	Diesel	85/88/100/110	939 A1.000;939 A2.000;939 A7.000;939 A8.000	MTM	06/05-03/11	Ch No: 2073592>;LHD	DAN994	14	100	
1.9 D Multijet	Diesel	85/88/100/110	939 A1.000;939 A2.000;939 A7.000;939 A8.000	ATM	06/05-03/11	Ch No: 2074131>;+ Ho; RHD	DAN995	14	120	
1.9 D Multijet	Diesel	85/88/100/110	939 A1.000;939 A2.000;939 A7.000;939 A8.000	MTM	06/05-	Ch No: >2073592;LHD	DAN513	14	120	
1.9 D Multijet	Diesel	85/88/100/110	939 A1.000;939 A2.000;939 A7.000;939 A8.000	ATM	06/05-	Ch No: >2074131>;+ Ho; RHD	DAN1062	14	140	
1.9 D Multijet	Diesel	85/88/100/110	939 A1.000;939 A2.000;939 A7.000;939 A8.000	ATM	03/11-	+ Ho;RHD	DAN1084	14	120	
1.9 D Multijet	Diesel	85/88/100/110	939 A1.000;939 A2.000;939 A7.000;939 A8.000	MTM	03/11-	LHD	DAN1147	14	100	
2.4 D Multijet	Diesel	147	939 A3.000		06/05-		DAN936	14	150	
DOBLO (01-)										
1.2	Petrol	48	223 A5.000		03/01-09/05	+ AC	DAN629	14	90	
1.2	Petrol	48	223 A5.000		03/01-09/05	Eng No: 2533528>;- AC	DAN998	14	70	
1.3 D Multijet	Diesel	55/62	199 A2.000;223 A9.000		10/05-	- AC	DAN1003	14	70	
1.3 D Multijet	Diesel	55/62	199 A2.000;223 A9.000		10/05-	- AC;+ Co;+ Ho	DAN1001	14	105	
1.3 D Multijet	Diesel	55/62	199 A2.000;223 A9.000		10/05-	+ AC	DAN1002	14	90	
1.3 D Multijet	Diesel	55/62	199 A2.000;223 A9.000		10/05-	+ AC;+ Co;+ Ho	DAN997	14	120	
1.3 JTD	Diesel	55	199 A2.000		05/05-	- AC	DAN1003	14	70	
1.3 JTD	Diesel	55	199 A2.000		05/05-	- AC;+ Co;+ Ho	DAN1001	14	105	
1.3 JTD	Diesel	55	199 A2.000		05/05-	+ AC	DAN1002	14	90	
1.3 JTD	Diesel	55	199 A2.000		05/05-	+ AC;+ Co;+ Ho	DAN997	14	120	
1.3 JTD 16V	Diesel	51	188 A8.000;188 A9.000		05/04-12/06	- AC	DAN1003	14	70	
1.3 JTD 16V	Diesel	51	188 A8.000;188 A9.000		05/04-12/06	+ AC	DAN1002	14	90	
1.3 JTD 16V	Diesel	51	188 A8.000;188 A9.000		05/04-12/06	+ AC;+ Ho	DAN997	14	120	
1.4	Petrol	57	350 A1.000		10/05-	- AC	DAN998	14	70	
1.4	Petrol	57	350 A1.000		10/05-	- AC;+ Co	DAN1004	14	90	
1.4	Petrol	57	350 A1.000		10/05-	+ AC	DAN517	14	70	
1.4	Petrol	57	350 A1.000		10/05-	+ AC;+ Co	DAN519	14	90	
1.9 D	Diesel	46	223 A6.000		03/01-	- AC	DAN640	14	65	
1.9 D	Diesel	46	223 A6.000		03/01-	+ AC	DAN520	14	90	
1.9 D	Diesel	46	223 A6.000		03/01-	+ AC;+ FDC	DAN501	14	105	
1.9 D Multijet	Diesel	88	186 A9.000		10/05-	- AC	DAN520	14	90	
1.9 D Multijet	Diesel	88	186 A9.000		10/05-	+ AC	DAN501	14	105	
1.9 D Multijet	Diesel	88	186 A9.000		10/05-	+ AC;+ Co;+ Ho	DAN502	14	120	
1.9 JTD	Diesel	74/77	182 B9.000;223 A7.000;223 B1.000;223 B2.000		10/01-	- AC	DAN520	14	90	
1.9 JTD	Diesel	74/77	182 B9.000;223 A7.000;223 B1.000;223 B2.000		10/01-	+ AC	DAN501	14	105	
1.9 JTD	Diesel	74/77	182 B9.000;223 A7.000;223 B1.000;223 B2.000		10/01-	+ AC;+ Co;+ Ho	DAN502	14	120	
DOBLO (10-)										
1.3 D Multijet	Diesel	55	263 A6.000		11/13-	-/+ AC;+ Co;+ Ho	DAN1311	14	120	
1.3 D Multijet	Diesel	55/66	263 A2.000;263 A6.000		02/10-	- AC	DAN1001	14	105	
1.3 D Multijet	Diesel	55/66	263 A2.000;263 A6.000		02/10-	+ AC	DAN997	14	120	
1.3 D Multijet	Diesel	59	225 A2.000		03/16-	+ AC	DAN1086	14	120	
1.3 D Multijet	Diesel	66	199 A3.000		02/10-	- AC	DAN1003	14	70	
1.3 D Multijet	Diesel	66	199 A3.000		02/10-	- AC;+ Co;+ Ho	DAN1001	14	105	
1.3 D Multijet	Diesel	66	199 A3.000		02/10-	+ AC	DAN1002	14	90	
1.3 D Multijet	Diesel	66	199 A3.000		02/10-	+ AC;+ Co;+ Ho	DAN997	14	120	
1.3 D Multijet	Diesel	66	263 A2.000		02/10-	-/+ AC;+ Co	DAN1311	14	120	
1.4	Petrol	70	843 A1.000		02/10-	- SS;- AC	DAN998	14	70	
1.4	Petrol	70	843 A1.000		02/10-	- SS;- AC;+ Co;+ Ho	DAN1004	14	90	
1.4	Petrol	70	843 A1.000		02/10-	- SS;+ AC	DAN519	14	90	
1.4	Petrol	70	843 A1.000		02/10-	- SS;+ AC;+ Co;+ Ho	DAN599	14	105	
1.4	Petrol	70	843 A1.000		02/10-	+ SS;- AC	DAN1005	14	105	
1.4	Petrol	70	843 A1.000		02/10-	+ SS;+ AC	DAN999	14	120	
1.4	Petrol	88	198 A4.000		10/11-	+ AC	DAN993	14	120	
1.4 Natural Power	Petrol/Compressed Natural Gas(CNG)	88	198 A4.000		02/10-10/17		DAN993	14	120	



A











FIAT continued									
DOBLO (10-) continued									
1.6 D Multijet	Diesel	66/74/77	198 A3.000;263 A3.000; 263 A4.000;263 A5.000; 263 A8.000;263 A9.000		01/10-	- AC	DAN994	14	100
1.6 D Multijet	Diesel	66/74/77	198 A3.000;263 A3.000; 263 A4.000;263 A5.000; 263 A8.000;263 A9.000		01/10-	-/+ AC;+ Co;+ Ho	DAN1123	14	150
1.6 D Multijet	Diesel	66/74/77	198 A3.000;263 A3.000; 263 A4.000;263 A5.000; 263 A8.000;263 A9.000		01/10-	+ AC	DAN995	14	120
2.0 D Multijet	Diesel	99	263 A1.000		01/10-	-/+ AC	DAN995	14	120
2.0 D Multijet	Diesel	99	263 A1.000		01/10-	-/+ AC;+ Co;+ Ho	DAN1123	14	150
DUCATO (250, 290) (06-)									
2.0 D Multijet 115	Diesel	85	250 A1.000;250 A2.000		06/11-	- AC;Passenger/Goods	DAN994	14	100
2.0 D Multijet 115	Diesel	85	250 A1.000;250 A2.000		06/11-	+ AC;Goods	DAN995	14	120
2.0 D Multijet 115	Diesel	85	250 A1.000;250 A2.000		06/11-	+ AC;Passenger	DAN1123	14	150
2.0 D Multijet 115	Diesel	85	250 A1.000;250 A2.000		06/11-	LPEGR;EU6	DAN1431	14	150
FIORINO (07-)									
1.3 D Multijet	Diesel	55	199 A2.000		11/07-	- AC	DAN1003	14	70
1.3 D Multijet	Diesel	55	199 A2.000		11/07-	- AC;+ Co;+ Ho	DAN1001	14	105
1.3 D Multijet	Diesel	55	199 A2.000		11/07-	+ AC	DAN1002	14	90
1.3 D Multijet	Diesel	55	199 A2.000		11/07-	+ AC;+ Co;+ Ho	DAN997	14	120
1.3 D Multijet	Diesel	55/70	199 A9.000;199 B1.000; 330 A1.000		11/07-	- AC	DAN1001	14	105
1.3 D Multijet	Diesel	55/70	199 A9.000;199 B1.000; 330 A1.000		11/07-	+ AC	DAN997	14	120
1.3 D Multijet	Diesel	55/70	199 A9.000;199 B1.000; 330 A1.000		11/07-	+ AC;ECO KIT	DAN1086	14	120
1.3 D Multijet	Diesel	59	225 A2.000;552 83 775		03/15-		DAN1086	14	120
1.4	Petrol	54	KFT;KfV		11/07-		DAN1336	14	90
1.4	Petrol	57	350 A1.000		10/09-03/16		DAN517	14	70
1.4 Natural Power	Petrol/ Compre ss ed Natur al Gas (CNG)	51/57	350 A1.000		06/08-		DAN517	14	70
Grande PUNTO (05-)									
1.2	Petrol	48	199 A4.000		10/05-	- AC;+ Co;+ Ho	DAN1005	14	105
1.2	Petrol	48	199 A4.000		10/05-	+ AC	DAN517	14	70
1.2	Petrol	48	199 A4.000		10/05-	+ AC;+ Co;+ Ho	DAN599	14	105
1.2	Petrol	48/51	169 A4.000;199 A4.000		10/05-	- AC	DAN998	14	70
1.2	Petrol	51	169 A4.000		09/10-	- AC	DAN1005	14	105
1.2	Petrol	51	169 A4.000		09/10-	+ AC	DAN999	14	120
1.3 D Multijet	Diesel	51	199 B2.000		07/08-	- SS;- AC	DAN1003	14	70
1.3 D Multijet	Diesel	51	199 B2.000		07/08-	- SS;+ AC	DAN1002	14	90
1.3 D Multijet	Diesel	51	199 B2.000		07/08-	- SS;+ AC;+ Co	DAN997	14	120
1.3 D Multijet	Diesel	55	199 A2.000		10/05-	- AC	DAN1003	14	70
1.3 D Multijet	Diesel	55	199 A2.000		10/05-	- AC;+ Ho	DAN1001	14	105
1.3 D Multijet	Diesel	55	199 A2.000		10/05-	+ AC	DAN1002	14	90
1.3 D Multijet	Diesel	55	199 A2.000		10/05-	+ AC;+ Co;+ Ho	DAN997	14	120
1.3 D Multijet	Diesel	55	199 A2.000		02/06-06/13	+ AC	DAN997	14	120
1.3 D Multijet	Diesel	62	199 B4.000		03/12-	+ AC	DAN1086	14	120
1.3 D Multijet	Diesel	62	199 B4.000;223 A9.000		04/10-	+ SS;- AC	DAN1001	14	105
1.3 D Multijet	Diesel	62	199 B4.000;223 A9.000		04/10-	+ SS;+ AC	DAN997	14	120
1.3 D Multijet	Diesel	62	199 B4.000;223 A9.000		04/10-	+ SS;+ AC;ECO KIT	DAN1086	14	120
1.3 D Multijet	Diesel	66	199 A3.000	5MTM	10/05-12/10	- AC	DAN1003	14	70
1.3 D Multijet	Diesel	66	199 A3.000	5MTM	10/05-12/10	- AC;+ Ho	DAN1001	14	105
1.3 D Multijet	Diesel	66	199 A3.000	6MTM	10/05-12/10	-/+ AC	DAN996	14	90
1.3 D Multijet	Diesel	66	199 A3.000	AMT	10/05-12/10	-/+ AC	DAN996	14	90
1.3 D Multijet	Diesel	66	199 A3.000	5MTM	10/05-12/10	+ AC	DAN1002	14	90
1.3 D Multijet	Diesel	66	199 A3.000	5MTM	10/05-12/10	+ AC;+ Co;+ Ho	DAN997	14	120
1.3 D Multijet	Diesel	66	199 A3.000	6MTM	10/05-12/10	+ AC;+ Ho	DAN1141	14	120
1.3 D Multijet	Diesel	66	199 A3.000	AMT	10/05-12/10	+ AC;+ Ho	DAN1141	14	120
1.3 D Multijet	Diesel	70	199 B1.000		03/12-	- AC	DAN1001	14	105
1.3 D Multijet	Diesel	70	199 B1.000	AMT	03/12-	-/+ AC	DAN1141	14	120
1.3 D Multijet	Diesel	70	199 B1.000		03/12-	+ AC	DAN997	14	120
1.4	Petrol	55	199 A7.000		10/05-07/07	- AC	DAN998	14	70
1.4	Petrol	55	199 A7.000		10/05-07/07	- AC;+ Co;+ Ho	DAN1005	14	105
1.4	Petrol	55	199 A7.000		10/05-07/07	+ AC	DAN517	14	70
1.4	Petrol	55	199 A7.000		10/05-07/07	+ AC;+ Co;+ Ho	DAN599	14	105

         									
FIAT continued									
Grande PUNTO (05-) continued									
1.4	Petrol	57	350 A1.000		06/05-12/15	- SS;- AC	DAN998	14	70
1.4	Petrol	57	350 A1.000		06/05-12/15	- SS;- AC;+ Co;+ Ho	DAN1005	14	105
1.4	Petrol	57	350 A1.000		06/05-12/15	- SS;+ AC	DAN517	14	70
1.4	Petrol	57	350 A1.000		06/05-12/15	- SS;+ AC;+ Co;+ Ho	DAN599	14	105
1.4	Petrol	57	350 A1.000		06/05-12/15	+ SS;- AC	DAN1005	14	105
1.4	Petrol	57	350 A1.000		06/05-12/15	+ SS;+ AC	DAN999	14	120
1.4 16V	Petrol	70	199 A6.000		10/05-08/11	- AC	DAN998	14	70
1.4 16V	Petrol	70	199 A6.000		10/05-08/11	- AC;+ Co;+ Ho	DAN1005	14	105
1.4 16V	Petrol	70	199 A6.000		10/05-08/11	+ AC	DAN517	14	70
1.4 16V	Petrol	70	199 A6.000		10/05-08/11	+ AC;+ Co;+ Ho	DAN599	14	105
1.4 LPG	Petrol/ Liquified Petrol Gas (LPG)	57	350 A1.000		12/08-	- AC;+ Co	DAN1005	14	105
1.4 LPG	Petrol/ Liquified Petrol Gas (LPG)	57	350 A1.000		12/08-	-/+ AC	DAN517	14	70
1.4 LPG	Petrol/ Liquified Petrol Gas (LPG)	57	350 A1.000		12/08-	+ AC;+ Co	DAN599	14	105
1.4 Natural Power	Petrol/ Compressed Natural Gas (CNG)	57	350 A1.000		07/08-	- AC;+ Co	DAN1005	14	105
1.4 Natural Power	Petrol/ Compressed Natural Gas (CNG)	57	350 A1.000		07/08-	-/+ AC	DAN517	14	70
1.4 Natural Power	Petrol/ Compressed Natural Gas (CNG)	57	350 A1.000		07/08-	+ AC;+ Co	DAN599	14	105
1.4 T-Jet	Petrol	88	198 A4.000		09/07-	- AC	DAN1005	14	105
1.4 T-Jet	Petrol	88	198 A4.000		09/07-	+ AC	DAN993	14	120
1.6 D Multijet	Diesel	88	955 A3.000		07/08-		DAN994	14	100
1.6 D Multijet	Diesel	88	955 A3.000		07/08-		DAN995	14	120
1.6 D Multijet	Diesel	88	955 A3.000		07/08-		DAN1062	14	140
1.9 D Multijet	Diesel	85/88/96	199 A5.000;939 A1.000; 939 A7.000		10/05-	RIC: >301042	DAN513	14	120
IDEA (03-)									
1.2 16V	Petrol	59	188 A5.000		01/04-	+ AC	DAN519	14	90
1.3 D Multijet	Diesel	51/66	188 A9.000;199 A3.000		01/04-12/10	- AC	DAN1003	14	70
1.3 D Multijet	Diesel	51/66	188 A9.000;199 A3.000		01/04-12/10	+ AC	DAN1002	14	90
1.3 D Multijet	Diesel	51/66	188 A9.000;199 A3.000		01/04-12/10	+ AC;+ Co	DAN997	14	120
1.3 D Multijet	Diesel	70	199 B1.000		05/08-12/12	- SS;+ AC	DAN1002	14	90
1.3 D Multijet	Diesel	70	199 B1.000		05/08-12/12	- SS;+ AC;+ Co	DAN997	14	120
1.3 D Multijet	Diesel	70	199 B1.000		05/08-12/12	+ SS	DAN997	14	120
1.4	Petrol	57	350 A1.000		10/05-	+ AC	DAN517	14	70
1.4	Petrol	57/66	192 B2.000;350 A1.000		12/03-	- AC	DAN998	14	70
1.4	Petrol	66	192 B2.000		12/03-	- SS;+ AC	DAN519	14	90
1.4	Petrol	66	192 B2.000		12/03-	+ SS;+ AC	DAN999	14	120
1.4 16V	Petrol	70	843 A1.000		01/04-	- AC	DAN998	14	70
1.4 16V	Petrol	70	843 A1.000		01/04-	- SS;+ AC	DAN519	14	90
1.4 16V	Petrol	70	843 A1.000		01/04-	+ SS;+ AC	DAN999	14	120
1.4 LPG	Petrol/ Liquified Petrol Gas (LPG)	57	350 A1.000		03/09-		DAN517	14	70



A











FIAT continued									
IDEA (03-) continued									
1.6 D Multijet	Diesel	88	350 A2.000		05/08-	- SS	DAN994	14	100
1.6 D Multijet	Diesel	88	350 A2.000		05/08-	+ SS	DAN995	14	120
1.9 JTD	Diesel	74	188 B2.000		01/04-06/06		DAN501	14	105
1.9 JTD	Diesel	74	188 B2.000		01/04-06/06	+ Co	DAN502	14	120
1.9 JTD	Diesel	74	188 B2.000		06/06-		DAN1365	14	90
LINEA (07-)									
1.3 D Multijet	Diesel	66	199 A3.000		06/07-	- AC	DAN1003	14	70
1.3 D Multijet	Diesel	66	199 A3.000		06/07-	- AC;+ Co;+ Ho	DAN1001	14	105
1.3 D Multijet	Diesel	66	199 A3.000		06/07-	+ AC	DAN1002	14	90
1.3 D Multijet	Diesel	66	199 A3.000		06/07-	+ AC;+ Co;+ Ho	DAN997	14	120
1.3 D Multijet	Diesel	70	199 A3.000;199 B1.000		09/09-	+ AC	DAN1002	14	90
1.4	Petrol	57	350 A1.000		06/07-	- AC	DAN998	14	70
1.4	Petrol	57	350 A1.000		06/07-	- AC;+ Co	DAN1005	14	105
1.4	Petrol	57	350 A1.000		06/07-	- AC;+ TUR	DAN1004	14	90
1.4	Petrol	57	350 A1.000		06/07-	+ AC	DAN519	14	90
1.4	Petrol	57	350 A1.000		06/07-	+ AC;+ Co	DAN599	14	105
1.4 T-Jet	Petrol	88	198 A4.000		05/07-		DAN993	14	120
1.6 D Multijet	Diesel	77	198 A3.000		06/09-		DAN994	14	100
1.6 D Multijet	Diesel	77	198 A3.000		06/09-	+ Co	DAN995	14	120
MAREA (96-07)									
1.2 16V	Petrol	60	182 B2.000		03/99-05/02	+ AC	DAN629	14	90
1.4 80 12V	Petrol	59	182 A3.000		09/96-05/02	+ AC	DAN1037	14	90
1.8 115 16V	Petrol	83	182 A2.000		09/96-05/02	Eng No: 429294>	DAN1037	14	90
1.9 JTD 105	Diesel	77	182 B4.000		12/98-12/02	Eng No: >1270131	DAN1037	14	90
1.9 JTD 105	Diesel	77	182 B4.000		12/98-12/02	Eng No: 1270131>	DAN501	14	105
1.9 JTD 110	Diesel	81	186 A6.000		09/00-08/02	- AC	DAN501	14	105
1.9 JTD 110	Diesel	81	186 A6.000		09/00-08/02	+ AC	DAN502	14	120
1.9 TD 100	Diesel	74	182 A7.000;182 B9.000		10/01-09/02	- AC	DAN501	14	105
2.4 JTD 130	Diesel	96	185 A6.000;839 A5.000		04/99-05/02		DAN1140	14	105
2.4 JTD 130	Diesel	96	185 A6.000;839 A5.000		04/99-05/02		DAN501	14	105
2.4 JTD 130	Diesel	96	185 A6.000;839 A5.000		04/99-05/02		DAN502	14	120
2.4 TD 125	Diesel	91	185 A2.000		09/96-04/99	Eng No: 0699589>;+ AC	DAN1140	14	105
2.4 TD 125	Diesel	91	185 A2.000		11/96-02/99	- AC	DAN1037	14	90
2.4 TD 125	Diesel	91	185 A2.000		11/96-02/99	Eng No: >0699589;+ AC	DAN1037	14	90
MULTIPLA (99-10)									
1.6 16V Bipower	Petrol/ Compressed Natural Gas (CNG)	76	182 B6.000	MTM	07/04-06/10	+ AC	DAN630	14	65
1.9 JTD	Diesel	88	186 A9.000		04/02-06/10	- AC	DAN520	14	90
1.9 JTD	Diesel	88	186 A9.000		04/02-06/10	+ AC	DAN501	14	105
1.9 JTD 105	Diesel	77	182 B4.000		04/99-06/10	- AC	DAN520	14	90
1.9 JTD 105	Diesel	77	182 B4.000		04/99-06/10	+ AC	DAN501	14	105
1.9 JTD 105	Diesel	77	182 B4.000		04/99-06/10	Taxi	DAN502	14	120
1.9 JTD 110	Diesel	81	186 A6.000		03/01-07/02	- AC	DAN520	14	90
1.9 JTD 110	Diesel	81	186 A6.000		03/01-07/02	+ AC	DAN501	14	105
1.9 JTD 115	Diesel	85	186 A8.000		07/02-06/10	- AC	DAN520	14	90
1.9 JTD 115	Diesel	85	186 A8.000		07/02-06/10	+ AC	DAN501	14	105
PALIO (96-)									
1.2	Petrol	44	178 C4.066;188 A4.000		07/97-02/05	+ AC;M8	DAN629	14	90
1.2	Petrol	44/54	176 A8.000;178 B5.000; 178 B7.045;178 C4.066; 178 E2.000;188 A4.000		04/96-	+ AC;+ PS	DAN629	14	90
1.2	Petrol	50	178 E2.000		06/99-10/00	+ AC	DAN629	14	90
1.2	Petrol	50/54	178 B5.000;178 E2.000		04/96-02/04	+ AC;+ PS;M9	DAN517	14	70
1.2	Petrol	54	178 B5.000	MTM	07/97-02/04	- AC	DAN630	14	65
1.2	Petrol	59	178 D6.011;188 A5.000		09/01-10/04	+ AC	DAN517	14	70
1.3 JTD Multijet	Diesel	51	188 A9.000		06/03-01/12	+ AC	DAN1002	14	90
1.7 TD	Diesel	51	176 A3.000		07/97-10/00	+ AC	DAN628	14	85
1.9 D	Diesel	46	223 A6.000		03/01-	- AC	DAN640	14	65
1.9 D	Diesel	46	223 A6.000		03/01-	+ AC	DAN520	14	90
1.9 JTD	Diesel	59	188 A2.000		09/01-	- AC	DAN640	14	65
1.9 JTD	Diesel	59	188 A2.000		09/01-	+ AC	DAN520	14	90
PANDA (03-)									
1.1	Petrol	40	187 A1.000		09/03-05/09	+ AC	DAN517	14	70
1.1	Petrol	40	187 A1.000		09/03-05/09	+ AC;+ Ho	DAN519	14	90

         									
FIAT continued									
PANDA (03-) continued									
1.1	Petrol	40	187 A1.000		09/03-	- AC	DAN998	14	70
1.1	Petrol	40	187 A1.000		05/09-	+ AC	DAN519	14	90
1.2	Petrol	44	188 A4.000		09/03-05/09	+ AC	DAN517	14	70
1.2	Petrol	44	188 A4.000		09/03-05/09	+ AC;+ Ho	DAN519	14	90
1.2	Petrol	44/51	169 A4.000;188 A4.000		09/03-	- AC	DAN998	14	70
1.2	Petrol	44/51	169 A4.000;188 A4.000		05/09-	+ AC	DAN519	14	90
1.2 4x4	Petrol	44	188 A4.000		09/04-05/09	+ AC;+ Ho	DAN519	14	90
1.2 4x4	Petrol	44	188 A4.000		05/09-	+ AC	DAN519	14	90
1.2 4x4	Petrol	44/51	169 A4.000;188 A4.000		09/04-	- AC	DAN998	14	70
1.2 4x4	Petrol	44/51	169 A4.000;188 A4.000		09/04-	+ AC	DAN517	14	70
1.2 LPG	Petrol/ Liquified Petroleum Gas (LPG)	44	188 A4.000		04/09-		DAN519	14	90
1.2 LPG	Petrol/ Liquified Petroleum Gas (LPG)	44/51	169 A4.000;188 A4.000		04/09-		DAN517	14	70
1.2 Natural Power	Petrol/ Compressed Natural Gas (CNG)	44	188 A4.000		01/07-05/09	+ AC	DAN517	14	70
1.2 Natural Power	Petrol/ Compressed Natural Gas (CNG)	44	188 A4.000		01/07-05/09	+ AC;+ Ho	DAN519	14	90
1.2 Natural Power	Petrol/ Compressed Natural Gas (CNG)	44	188 A4.000		01/07-12/11	- AC	DAN998	14	70
1.2 Natural Power	Petrol/ Compressed Natural Gas (CNG)	44	188 A4.000		05/09-12/11	+ AC	DAN519	14	90
1.3 D Multijet	Diesel	51/55	169 A1.000;169 A5.000; 188 A8.000		09/03-	- AC	DAN1003	14	70
1.3 D Multijet	Diesel	51/55	169 A1.000;169 A5.000; 188 A8.000		09/03-	+ AC	DAN1002	14	90
1.3 D Multijet 4x4	Diesel	51	188 A8.000		10/04-12/06	+ AC	DAN1002	14	90
1.3 D Multijet 4x4	Diesel	51/55	169 A1.000;169 A5.000; 188 A8.000		10/04-	+ AC	DAN1002	14	90
1.3 D Multijet 4x4	Diesel	51/55	169 A1.000;188 A8.000		10/04-	- AC	DAN1003	14	70
1.3 D Multijet 4x4	Diesel	55	169 A5.000		09/10-08/13	- AC	DAN1001	14	105
1.4	Petrol	74	169 A3.000		10/06-		DAN517	14	70
1.4 Natural Power	Petrol/ Compressed Natural Gas (CNG)	57	350 A1.000		10/09-	- AC	DAN517	14	70
1.4 Natural Power	Petrol/ Compressed Natural Gas (CNG)	57	350 A1.000		10/09-	+ AC	DAN519	14	90
PANDA (12-)									
0.9	Petrol	44/48	312 A4.000;312 A6.000		02/12-		DAN1078	14	120
0.9 Natural Power	Petrol/ Compressed Natural Gas (CNG)	59/63	312 A2.000;463 37 566		07/12-		DAN993	14	120



A









FIAT continued									
PANDA (12-) continued									
0.9 TwinAir	Petrol	57/59/63/66	312 A2.000;312 A5.000; 312 A7.000		02/12-		DAN1078	14	120
0.9 TwinAir 4x4	Petrol	63	312 A2.000		09/12-		DAN1078	14	120
1.2	Petrol	51	169 A4.000		02/12-	- AC	DAN998	14	70
1.2	Petrol	51	169 A4.000		02/12-	+ AC	DAN519	14	90
1.2 LPG	Petrol/ Liquified Petroleum Gas (LPG)	51	169 A4.000		06/12-	- AC	DAN517	14	70
1.2 LPG	Petrol/ Liquified Petroleum Gas (LPG)	51	169 A4.000		06/12-	+ AC	DAN519	14	90
1.3 D Multijet	Diesel	55	199 A1.000;199 A9.000		02/12-	- AC	DAN1001	14	105
1.3 D Multijet	Diesel	55	199 A1.000;199 A9.000		02/12-	+ AC	DAN997	14	120
1.3 D Multijet	Diesel	59/70	199 B1.000;225 A2.000; 312 A8.000;312 B1.000; 312 B2.000;330 A1.000		04/15-		DAN1086	14	120
1.3 D Multijet 4x4	Diesel	55	199 A1.000;199 A9.000		06/12-	- AC	DAN1001	14	105
1.3 D Multijet 4x4	Diesel	55	199 A1.000;199 A9.000		06/12-	+ AC	DAN997	14	120
1.3 D Multijet 4x4	Diesel	59/70	199 B1.000;225 A2.000; 312 A8.000;312 B1.000; 312 B2.000;330 A1.000		06/14-		DAN1086	14	120
PUNTO (93-00)									
1.1	Petrol	40	176 B2.000		05/97-02/00	+ AC;+ PS	DAN629	14	90
1.1 55	Petrol	40	176 A6.000;176 B2.000		05/97-09/99	+ AC;+ PS	DAN629	14	90
1.2 16V	Petrol	63	176 B9.000		04/97-09/99	+ AC;+ PS	DAN629	14	90
1.2 16V 85	Petrol	63	176 B9.000		04/97-06/00	+ AC;+ PS	DAN629	14	90
1.2 60	Petrol	43	176 A7.000		05/97-06/00	+ AC;+ PS	DAN629	14	90
1.2 75	Petrol	54	176 A8.000		10/93-09/99	+ AC;+ PS	DAN629	14	90
1.7 D	Diesel	42	176 B3.000		04/94-02/00	+ AC	DAN628	14	85
1.7 TD	Diesel	46/51	176 A3.000;176 A5.000; 176 B7.000		01/94-02/00	+ AC	DAN628	14	85
60 1.2	Petrol	44	176 B1.000;176 B4.000		09/93-06/00	+ AC;+ PS	DAN629	14	90
PUNTO (99-12)									
1.2 16V 80	Petrol	59	188 A5.000		09/99-06/03	+ AC;+ Co;LHD	DAN519	14	90
1.2 16V 80	Petrol	59	188 A5.000		09/99-06/03	+ AC;+ Ho;LHD	DAN599	14	105
1.2 16V 80	Petrol	59	188 A5.000		09/99-06/03	+ AC;RHD	DAN629	14	90
1.2 16V 80	Petrol	59	188 A5.000		12/99-06/03	+ AC;LHD	DAN517	14	70
1.2 16V 80	Petrol	59	188 A5.000		06/03-04/06	+ AC	DAN517	14	70
1.2 16V 80	Petrol	59	188 A5.000		06/03-04/06	+ AC;+ Co	DAN519	14	90
1.2 16V 80	Petrol	59	188 A5.000		06/03-04/06	+ AC;+ Ho	DAN599	14	105
1.2 60	Petrol	44	188 A4.000		09/99-06/03	+ AC;+ Ho;LHD	DAN599	14	105
1.2 60	Petrol	44	188 A4.000		09/99-06/03	+ AC;RHD	DAN629	14	90
1.2 60	Petrol	44	188 A4.000		12/99-06/03	+ AC;LHD	DAN517	14	70
1.2 60	Petrol	44	188 A4.000		06/03-12/10	+ AC	DAN517	14	70
1.2 60	Petrol	44	188 A4.000		06/03-12/10	+ AC;+ Ho	DAN599	14	105
1.2 60	Petrol	44	188 A4.000		06/03-12/10	Eng No: 2533528>;- AC	DAN998	14	70
1.2 BiFuel	Petrol/ Liquified Petroleum Gas (LPG)	44	188 A4.000		08/07-03/12		DAN517	14	70
1.2 Bipower	Flexfuel	44	188 A4.000		05/02-05/03	+ AC;LHD	DAN517	14	70
1.2 Natural Power	Petrol/ Compressed Natural Gas (CNG)	44	188 A4.000		09/03-03/12	- AC	DAN998	14	70
1.2 Natural Power	Petrol/ Compressed Natural Gas (CNG)	44	188 A4.000		09/03-03/12	+ AC	DAN517	14	70











																			
FIAT continued																			
PUNTO (99-12) continued																			
1.3 JTD	Diesel	51	188 A9.000			06/03-10/05	- AC	DAN1003	14	70									
1.3 JTD	Diesel	51	188 A9.000			06/03-10/05	- AC;+ Co;+ Ho	DAN1001	14	105									
1.3 JTD	Diesel	51	188 A9.000			06/03-10/05	+ AC	DAN1002	14	90									
1.3 JTD	Diesel	51	188 A9.000			06/03-10/05	+ AC;+ Co;+ Ho	DAN997	14	120									
1.3 JTD 16V	Diesel	51	188 A9.000			06/03-03/12	- AC	DAN1003	14	70									
1.3 JTD 16V	Diesel	51	188 A9.000			06/03-03/12	- AC;+ Co;+ Ho	DAN1001	14	105									
1.3 JTD 16V	Diesel	51	188 A9.000			06/03-03/12	+ AC	DAN1002	14	90									
1.3 JTD 16V	Diesel	51	188 A9.000			06/03-03/12	+ AC;+ Co;+ Ho	DAN997	14	120									
1.4	Petrol	70	843 A1.000			09/03-03/12	- AC	DAN998	14	70									
1.4	Petrol	70	843 A1.000			09/03-03/12	+ AC	DAN517	14	70									
1.4	Petrol	70	843 A1.000			09/03-03/12	+ AC;+ Ho	DAN599	14	105									
1.8 130 HGT	Petrol	96	183 A1.000;188 A6.000			09/99-02/02	Eng No: >2850151	DAN1140	14	105									
1.8 130 HGT	Petrol	96	183 A1.000;188 A6.000			09/99-02/02	Eng No: >2850151;+ Ho;+ FDC	DAN641	14	120									
1.9 D 60	Diesel	44	188 A3.000			02/00-10/09	+ AC;+ Ho;+ FDC	DAN502	14	120									
1.9 D 60	Diesel	44	188 A3.000			07/00-10/09	Eng No: 1839341>;+ AC	DAN520	14	90									
1.9 DS 60	Diesel	44	188 A3.000			09/99-03/12	+ AC;+ Ho;+ FDC	DAN502	14	120									
1.9 DS 60	Diesel	44	188 A3.000			07/00-03/12	Eng No: 1839341>;+ AC	DAN520	14	90									
1.9 JTD	Diesel	63	188 A7.000			02/00-03/12	- AC	DAN520	14	90									
1.9 JTD	Diesel	63	188 A7.000			02/00-03/12	+ AC	DAN501	14	105									
1.9 JTD	Diesel	74	188 B2.000			06/03-03/12		DAN501	14	105									
1.9 JTD 80	Diesel	59	188 A2.000			09/99-07/00	Eng No: >1839341>;- AC	DAN1037	14	90									
1.9 JTD 80	Diesel	59	188 A2.000			10/99-03/12	Eng No: 1645241>;+ AC	DAN501	14	105									
1.9 JTD 80	Diesel	59	188 A2.000			07/00-03/12	Eng No: 1839341>;- AC	DAN520	14	90									
PUNTO (12-)																			
0.9 Twinair	Petrol	63/74/77	199 B6.000;199 B7.000;312 A2.000			03/12-		DAN1078	14	120									
0.9 Twinair	Petrol	63/74/77	199 B6.000;199 B7.000;312 A2.000			03/12-	+ Co	DAN1089	14	120									
1.2	Petrol	49	199 B9.000			02/14-	- AC	DAN998	14	70									
1.2	Petrol	49	199 B9.000			02/14-	- AC;+ Co	DAN1004	14	90									
1.2	Petrol	49	199 B9.000			02/14-	+ AC	DAN517	14	70									
1.2	Petrol	49	199 B9.000			02/14-	+ AC;+ Co	DAN519	14	90									
1.2	Petrol	51	169 A4.000			03/12-	- SS;- AC	DAN1004	14	90									
1.2	Petrol	51	169 A4.000			03/12-	- SS;+ AC	DAN519	14	90									
1.2	Petrol	51	169 A4.000			03/12-	+ SS;- AC	DAN1005	14	105									
1.2	Petrol	51	169 A4.000			03/12-	+ SS;+ AC	DAN999	14	120									
1.3 D Multijet	Diesel	62	199 B4.000			03/12-	+ AC	DAN1086	14	120									
1.3 D Multijet	Diesel	70	199 B1.000;330 A1.000			03/12-	- AC	DAN1001	14	105									
1.3 D Multijet	Diesel	70	199 B1.000;330 A1.000	AMT		03/12-	-/+ AC	DAN1141	14	120									
1.3 D Multijet	Diesel	70	199 B1.000;330 A1.000			03/12-	+ AC	DAN997	14	120									
1.4	Petrol	55/57	199 A7.000;350 A1.000			03/12-	- AC;+ Co;+ Ho;EU4	DAN1005	14	105									
1.4	Petrol	55/57	199 A7.000;350 A1.000			03/12-	- AC;EU4	DAN998	14	70									
1.4	Petrol	55/57	199 A7.000;350 A1.000			03/12-	- SS;+ AC;EU5	DAN519	14	90									
1.4	Petrol	55/57	199 A7.000;350 A1.000			03/12-	+ AC;+ Co;+ Ho;EU4	DAN599	14	105									
1.4	Petrol	55/57	199 A7.000;350 A1.000			03/12-	+ AC;EU4	DAN517	14	70									
1.4	Petrol	55/57	199 A7.000;350 A1.000			03/12-	+ SS;- AC;EU5	DAN1005	14	105									
1.4	Petrol	55/57	199 A7.000;350 A1.000			03/12-	+ SS;+ AC;EU5	DAN999	14	120									
1.4 BiFuel	Petrol/ Liquified Petroleum Gas (LPG)	57	350 A1.000			03/12-		DAN519	14	90									
1.4 BiFuel	Petrol/ Liquified Petroleum Gas (LPG)	57	350 A1.000			03/12-	+ Co	DAN599	14	105									
1.4 MultiAir	Petrol	77	955 A6.000			03/12-	+ AC	DAN1085	14	120									
1.4 MultiAir	Petrol	99	955 A2.000			03/12-	+ AC	DAN993	14	120									
1.4 Natural Power	Petrol/ Compressed Natural Gas (CNG)	57	350 A1.000			03/12-		DAN519	14	90									



A







FIAT continued										
PUNTO (12-) continued										
1.4 Natural Power	Petrol/Compressed Natural Gas (CNG)	57	350 A1.000		03/12-	+ Co	DAN599	14	105	
PUNTO Evo (08-12)										
1.2	Petrol	48	199 A4.000		10/09-02/12	- AC	DAN998	14	70	
1.2	Petrol	48	199 A4.000		10/09-02/12	- AC;+ Co	DAN1004	14	90	
1.2	Petrol	48	199 A4.000		10/09-02/12	+ AC	DAN517	14	70	
1.2	Petrol	48	199 A4.000		10/09-02/12	+ AC;+ Co	DAN519	14	90	
1.2	Petrol	51	169 A4.000		10/09-02/12	- SS;- AC	DAN1004	14	90	
1.2	Petrol	51	169 A4.000		10/09-02/12	- SS;+ AC	DAN519	14	90	
1.2	Petrol	51	169 A4.000		10/09-02/12	+ SS;- AC	DAN1005	14	105	
1.2	Petrol	51	169 A4.000		10/09-02/12	+ SS;+ AC	DAN999	14	120	
1.3 D Multijet	Diesel	51/55	199 A2.000;199 B2.000		07/08-02/12	- SS;- AC	DAN1003	14	70	
1.3 D Multijet	Diesel	51/55	199 A2.000;199 B2.000		07/08-02/12	- SS;+ AC	DAN1002	14	90	
1.3 D Multijet	Diesel	51/55	199 A2.000;199 B2.000		07/08-02/12	- SS;+ AC;+ Co	DAN997	14	120	
1.3 D Multijet	Diesel	55	199 A9.000		10/09-02/12	+ SS;-/+ AC	DAN997	14	120	
1.3 D Multijet	Diesel	62	199 B4.000;223 A9.000		10/09-02/12	+ SS;- AC	DAN1001	14	105	
1.3 D Multijet	Diesel	62	199 B4.000;223 A9.000		10/09-02/12	+ SS;+ AC	DAN997	14	120	
1.3 D Multijet	Diesel	62	199 B4.000;223 A9.000		10/09-02/12	+ SS;+ AC;ECO KIT	DAN1086	14	120	
1.3 D Multijet	Diesel	66	199 A3.000		03/09-02/12	+ AC	DAN1002	14	90	
1.3 D Multijet	Diesel	66	199 A3.000	5MTM	10/09-02/12	- AC	DAN1003	14	70	
1.3 D Multijet	Diesel	66	199 A3.000	6MTM	10/09-02/12	-/+ AC	DAN996	14	90	
1.3 D Multijet	Diesel	66	199 A3.000	AMT	10/09-02/12	-/+ AC	DAN996	14	90	
1.3 D Multijet	Diesel	66	199 A3.000	5MTM	10/09-02/12	+ AC	DAN1002	14	90	
1.3 D Multijet	Diesel	66	199 A3.000	5MTM	10/09-02/12	+ AC;+ Co	DAN997	14	120	
1.3 D Multijet	Diesel	70	199 B1.000		10/09-02/12	- AC	DAN1001	14	105	
1.3 D Multijet	Diesel	70	199 B1.000	AMT	10/09-02/12	-/+ AC	DAN1141	14	120	
1.3 D Multijet	Diesel	70	199 B1.000		10/09-02/12	+ AC	DAN997	14	120	
1.4	Petrol	55/57	199 A7.000;350 A1.000		07/09-02/12	- AC;+ Co;EU4	DAN1004	14	90	
1.4	Petrol	55/57	199 A7.000;350 A1.000		07/09-02/12	- AC;EU4	DAN998	14	70	
1.4	Petrol	55/57	199 A7.000;350 A1.000		07/09-02/12	- SS;- AC;EU5	DAN1004	14	90	
1.4	Petrol	55/57	199 A7.000;350 A1.000		07/09-02/12	- SS;+ AC;EU5	DAN519	14	90	
1.4	Petrol	55/57	199 A7.000;350 A1.000		07/09-02/12	+ AC;+ Co;EU4	DAN519	14	90	
1.4	Petrol	55/57	199 A7.000;350 A1.000		07/09-02/12	+ AC;EU4	DAN517	14	70	
1.4	Petrol	55/57	199 A7.000;350 A1.000		07/09-02/12	+ SS;- AC;EU5	DAN1005	14	105	
1.4	Petrol	55/57	199 A7.000;350 A1.000		07/09-02/12	+ SS;+ AC;EU5	DAN999	14	120	
1.4	Petrol	57	350 A1.000		03/09-02/12	For vehicles without air conditioning	DAN1005	14	105	
1.4 16V	Petrol	77	955 A6.000		10/09-02/12	+ AC	DAN1085	14	120	
1.4 16V	Petrol	99	955 A2.000		10/09-02/12	+ AC	DAN993	14	120	
1.4 LPG	Petrol/Liquid Petroleum Gas (LPG)	57	350 A1.000		06/09-02/12	- AC	DAN517	14	70	
1.4 LPG	Petrol/Liquid Petroleum Gas (LPG)	57	350 A1.000		06/09-02/12	+ AC	DAN519	14	90	
1.4 Natural Power	Petrol/Compressed Natural Gas (CNG)	57	350 A1.000		10/09-02/12	- AC	DAN517	14	70	
1.4 Natural Power	Petrol/Compressed Natural Gas (CNG)	57	350 A1.000		10/09-02/12	+ AC	DAN519	14	90	











			 kW						A
FIAT continued									
PUNTO Evo (08-12) continued									
1.6 D Multijet	Diesel	88	955 A3.000		10/09-02/12	- SS	DAN994	14	100
1.6 D Multijet	Diesel	88	955 A3.000		10/09-02/12	+ SS;+ AC	DAN995	14	120
QUBO (08-)									
1.3 D Multijet	Diesel	55	199 A2.000;199 A9.000		02/08-	- AC	DAN1003	14	70
1.3 D Multijet	Diesel	55	199 A2.000;199 A9.000		02/08-	- AC;+ Co;+ Ho	DAN1001	14	105
1.3 D Multijet	Diesel	55	199 A2.000;199 A9.000		02/08-	+ AC	DAN1002	14	90
1.3 D Multijet	Diesel	55	199 A2.000;199 A9.000		02/08-	+ AC;+ Co;+ Ho	DAN997	14	120
1.3 D Multijet	Diesel	59	225 A2.000		03/15-		DAN1086	14	120
1.3 D Multijet	Diesel	70	199 B1.000;330 A1.000; 552 83 775		07/10-	- AC	DAN1001	14	105
1.3 D Multijet	Diesel	70	199 B1.000;330 A1.000; 552 83 775		07/10-	+ AC	DAN997	14	120
1.3 D Multijet	Diesel	70	199 B1.000;330 A1.000; 552 83 775		07/10-	+ AC;ECO KIT	DAN1086	14	120
1.4	Petrol	54	KFT;KfV		02/08-		DAN1336	14	90
1.4	Petrol	57	350 A1.000		10/09-03/16		DAN517	14	70
1.4 Natural Power	Petrol/ Compre ss ed Natur al Gas(CNG)	57	350 A1.000		10/09-		DAN517	14	70
SCUDO (220) (96-06)									
1.9 D	Diesel	51	WJY (DW8B); WJZ (DW8)		04/98-12/06		DAN1336	14	90
2.0	Petrol	100	RFN (EW10J4)		05/00-12/06	MY: 2004>	DAN1336	14	90
2.0 16V	Petrol	100	RFN (EW10J4)		06/00-12/06	MY: 2004>	DAN1336	14	90
SEDICI (06-14)									
1.9 D Multijet	Diesel	88	D19AA		06/06-10/11		DAN1062	14	140
1.9 D Multijet 4x4	Diesel	88	D19AA		06/06-10/11		DAN1062	14	140
SEICENTO (98-10)									
1.1	Petrol	40	187 A1.000		09/00-01/10	+ AC	DAN631	14	90
STILO (01-08)									
1.2 16V	Petrol	59	188 A5.000		02/02-11/06	+ AC	DAN519	14	90
1.2 16V	Petrol	59	188 A5.000		02/02-11/06	+ AC;+ Co	DAN599	14	105
1.4 16V	Petrol	66/70	192 B2.000;843 A1.000		10/03-08/08	- AC	DAN998	14	70
1.4 16V	Petrol	66/70	192 B2.000;843 A1.000		10/03-08/08	- AC;+ Co	DAN1005	14	105
1.4 16V	Petrol	66/70	192 B2.000;843 A1.000		10/03-08/08	+ AC	DAN519	14	90
1.4 16V	Petrol	66/70	192 B2.000;843 A1.000		10/03-08/08	+ AC;+ Co	DAN599	14	105
1.8 16V	Petrol	98	192 A4.000		10/01-02/03		DAN641	14	120
1.8 16V	Petrol	98	192 A4.000		10/01-08/08		DAN502	14	120
1.8 16V	Petrol	98	192 A4.000		10/01-08/08	+ Ho	DAN641	14	120
1.9 D	Diesel	66	192 B5.000		09/04-08/08	Ch No: >0066902;- AC	DAN520	14	90
1.9 D	Diesel	66	192 B5.000		09/04-08/08	Ch No: >0066902;+ AC	DAN501	14	105
1.9 D	Diesel	66	192 B5.000		09/04-08/08	Ch No: 0066902>	DAN1365	14	90
1.9 D	Diesel	66	192 B5.000		09/04-08/08	Ch No: 0066902;>+ Ho	DAN501	14	105
1.9 D Multijet	Diesel	74	192 A9.000		09/05-10/05	- AC	DAN520	14	90
1.9 D Multijet	Diesel	74	192 A9.000		09/05-10/05	+ AC	DAN501	14	105
1.9 D Multijet	Diesel	74	192 A9.000		10/05-08/08	-/+ AC	DAN1365	14	90
1.9 D Multijet	Diesel	88	192 A8.000		09/05-08/08	Ch No: >0066902;- AC	DAN520	14	90
1.9 D Multijet	Diesel	88	192 A8.000		09/05-08/08	Ch No: >0066902;+ AC	DAN501	14	105
1.9 D Multijet	Diesel	88	192 A8.000		09/05-08/08	Ch No: 0066902>	DAN1365	14	90
1.9 D Multijet	Diesel	88	192 A8.000		09/05-08/08	Ch No: 0066902;>+ Ho	DAN501	14	105
1.9 D Multijet	Diesel	110	937 A5.000		09/05-12/07		DAN513	14	120
1.9 JTD	Diesel	59/85	192 A1.000;192 A3.000; 937 A7.000		10/01-11/02	- AC	DAN501	14	105
1.9 JTD	Diesel	59/85	192 A1.000;192 A3.000; 937 A7.000		10/01-11/02	+ AC	DAN502	14	120
1.9 JTD	Diesel	59/85	192 A1.000;192 A3.000; 937 A7.000		11/02-10/05	- AC	DAN520	14	90
1.9 JTD	Diesel	59/85	192 A1.000;192 A3.000; 937 A7.000		11/02-10/05	+ AC	DAN501	14	105
1.9 JTD	Diesel	59/85	192 A1.000;192 A3.000; 937 A7.000		10/05-08/08	-/+ AC	DAN1365	14	90
1.9 JTD	Diesel	66	192 B5.000		09/04-11/06	Ch No: >0066902;- AC	DAN520	14	90
1.9 JTD	Diesel	66	192 B5.000		09/04-11/06	Ch No: >0066902;+ AC	DAN501	14	105
1.9 JTD	Diesel	66	192 B5.000		09/04-11/06	Ch No: 0066902>	DAN1365	14	90
1.9 JTD	Diesel	66	192 B5.000		09/04-11/06	Ch No: 0066902;>+ Ho	DAN501	14	105
1.9 JTD	Diesel	85	192 A1.000;937 A7.000		11/02-08/08	-/+ AC;+ Co;+ Ho	DAN502	14	120
1.9 JTD	Diesel	93/100/ 103	192 A5.000;192 B1.000; 937 A4.000		09/03-12/07		DAN513	14	120

         									
FIAT continued									
STRADA (99-)									
1.2	Petrol	44	188 A4.000		04/03-	+ AC	DAN517	14	70
1.2	Petrol	54	178 B5.000		06/99-02/05	+ AC;+ PS;M1	DAN629	14	90
1.2	Petrol	54	178 B5.000	MTM	02/00-12/06	- PS	DAN630	14	65
1.3 D Multijet	Diesel	62	223 A9.000		05/06-	- AC	DAN1003	14	70
1.3 D Multijet	Diesel	62	223 A9.000		05/06-	- AC;+ Ho	DAN1001	14	105
1.3 D Multijet	Diesel	62	223 A9.000		05/06-	+ AC	DAN1002	14	90
1.3 D Multijet	Diesel	62	223 A9.000		05/06-	+ AC;+ Ho	DAN997	14	120
1.7 TD	Diesel	51	176 A3.000		06/99-03/03	+ AC	DAN628	14	85
1.9 D	Diesel	46	223 A6.000	MTM	06/01-	+ AC	DAN520	14	90
1.9 JTD	Diesel	59	188 A2.000		04/03-06/05	- AC	DAN640	14	65
1.9 JTD	Diesel	59	188 A2.000	MTM	04/03-	+ AC	DAN520	14	90
STRADA (10-)									
1.3 D Multijet	Diesel	70	199 B1.000		10/10-	- AC	DAN1003	14	70
1.3 D Multijet	Diesel	70	199 B1.000		10/10-	+ AC	DAN1002	14	90
TEMPRA (90-96)									
1.8 i.e.	Petrol	66/74/77	159 A4.046;835 C2.000; 835 C4.000;836 A5.000	MTM	03/92-08/96		DAN615	14	65
1.8 i.e.	Petrol	77/81	159 A4.000;159 A4.046; 835 C2.000	MTM	03/90-08/96	- AC	DAN615	14	65
2.0 i.e.	Petrol	83	159 A6.046	MTM	10/90-06/93	- AC	DAN615	14	65
2.0 i.e. 4x4	Petrol	83	159 A6.046	MTM	07/92-03/95		DAN615	14	65
TIPO (160) (87-95)									
1.8 i.e.	Petrol	66/74/77	159 A4.000;159 A4.046; 835 C2.000;835 C4.000; 836 A5.000	MTM	11/92-10/95		DAN615	14	65
1.8 i.e. 16V Sport	Petrol	100	160 A5.000	MTM	04/90-06/92		DAN615	14	65
2.0 i.e.	Petrol	80/83	159 A5.046;159 A6.046	MTM	03/90-04/95		DAN615	14	65
TIPO (356) (15-)									
1.3 D	Diesel	70	199 B1.000;552 66 963; 552 83 775		10/15-	- SS;+ Co	DAN1311	14	120
1.3 D	Diesel	70	199 B1.000;552 66 963; 552 83 775		10/15-	+ SS	DAN1086	14	120
1.3 D	Diesel	70	199 B1.000;552 66 963; 552 83 775		10/15-	+ SS;+ Co	DAN1310	14	120
1.4	Petrol	70	843 A1.000		10/15-		DAN519	14	90
1.4	Petrol	70	843 A1.000		10/15-	+ Co	DAN1429	14	120
1.4	Petrol	70	843 A1.000		10/15-	+ Ho	DAN999	14	120
1.4	Petrol	70/88	843 A1.000;940 B7.000		03/16-	- SS;+ Co	DAN1429	14	120
1.4	Petrol	70/88	843 A1.000;940 B7.000		03/16-	- SS;+ Ho	DAN999	14	120
1.4	Petrol	70/88	843 A1.000;940 B7.000		03/16-	+ SS	DAN1078	14	120
1.4	Petrol	70/88	843 A1.000;940 B7.000		03/16-	+ SS;+ Co	DAN1089	14	120
1.4 LPG	Petrol/ Liquified Petroleum Gas (LPG)	88	940 B7.000		05/16-		DAN993	14	120
1.6 D	Diesel	84/88	552 60 384;552 80 444; 940 C1.000		10/15-	- SS	DAN1147	14	100
1.6 D	Diesel	84/88	552 60 384;552 80 444; 940 C1.000		10/15-	- SS;+ Co	DAN1066	14	120
1.6 D	Diesel	84/88	552 60 384;552 80 444; 940 C1.000		10/15-	+ SS	DAN1121	14	120
1.6 D	Diesel	84/88	552 60 384;552 80 444; 940 C1.000		10/15-	+ SS;+ Co	DAN1146	14	150
ULYSSE (02-11)									
2.0	Petrol	100	RFN (EW10J4)		08/02-06/11		DAN1336	14	90
FORD									
B-MAX (12-)									
1.0 EcoBoost	Petrol	74/88/ 92/103	M1JA;M1JE;M1JH; SFJA;SFJB;SFJC; SFJD;YYJC		10/12-		DAN1073	14	150
C-MAX I (07-10)									
1.6	Petrol	74/85	HWDA;HWDB;HXDA; HXDB;SHDA;SHDB; SHDC;SIDA		02/07-09/10		DAN588	14	105
1.6 TDCi	Diesel	66/74/80	G8DA;G8DB;G8DC; G8DD;GPDA;HHDA; HHDB;MTDA		02/07-12/09		DAN1119	14	120
1.6 TDCi	Diesel	66/74/80	G8DA;G8DB;G8DC; G8DD;GPDA;HHDA; HHDB;MTDA		02/07-12/09		DAN930	14	150

Starters & Alternators









Application Tables - Alternators

		 kW							A
FORD continued									
C-MAX I (07-10) continued									
1.6 TDCi	Diesel	66/74/80	G8DA;G8DB;G8DC;G8DD;GPDA;HHDA;HHDB;MTDA		01/10-08/10		DAN1139	14	120
1.6 TDCi	Diesel	66/74/80	G8DA;G8DB;G8DC;G8DD;GPDA;HHDA;HHDB;MTDA		01/10-08/10		DAN1118	14	150
1.8	Petrol	90/92	QQDA;QQDB;QQDC		02/07-08/10		DAN1023	14	120
1.8 FlexFuel	Flexfuel	92	Q7DA		02/07-08/10		DAN1023	14	120
1.8 TDCi	Diesel	85	KKDA;KKDB		02/07-09/10	- AC;+ EAH;+ PH;+ HWS	DAN933	14	150
1.8 TDCi	Diesel	85	KKDA;KKDB		02/07-09/10	+ AC;- EAH;- PH	DAN582	14	105
1.8 TDCi	Diesel	85	KKDA;KKDB		02/07-09/10	+ AC;+ EAH;+ PH	DAN932	14	150
2.0	Petrol	107	AODA;AODB;AODE;SYDA	ATM	02/07-08/10		DAN1023	14	120
2.0	Petrol	107	AODA;AODB;AODE;SYDA	MTM	02/07-08/10		DAN1016	14	120
2.0 CNG	Petrol/Compressed Natural Gas (CNG)	107	SYDA	ATM	04/09-08/10		DAN1023	14	120
2.0 CNG	Petrol/Compressed Natural Gas (CNG)	107	SYDA	MTM	04/09-08/10		DAN1016	14	120
2.0 LPG	Petrol/Liquefied Petroleum Gas (LPG)	107	SYDA	ATM	06/08-08/10		DAN1023	14	120
2.0 LPG	Petrol/Liquefied Petroleum Gas (LPG)	107	SYDA	MTM	06/08-08/10		DAN1016	14	120
2.0 TDCi	Diesel	81/98/100	G6DA;G6DB;G6DC;G6DD;G6DE;G6DF;G6DG;XDA		02/07-09/10		DAN1119	14	120
2.0 TDCi	Diesel	81/98/100	G6DA;G6DB;G6DC;G6DD;G6DE;G6DF;G6DG;XDA		02/07-09/10		DAN930	14	150
C-MAX II (10-)									
1.0 EcoBoost	Petrol	74/92	M1DA;M1DD;M2DA;M2DC	MTM	10/12-	- EAH;- PH	DAN1313	14	120
1.0 EcoBoost	Petrol	74/92	M1DA;M1DD;M2DA;M2DC	MTM	10/12-	+ EAH;+ PH	DAN1074	14	150
ECOSPORT (12-)									
1.0 EcoBoost	Petrol	92	M1JC;M1JJ;M1JU		10/13-	- EAH	DAN1312	14	120
1.0 EcoBoost	Petrol	92	M1JC;M1JJ;M1JU		10/13-	+ EAH	DAN1073	14	150
1.0 EcoBoost	Petrol	103	YYJD		03/16-		DAN1073	14	150
ESCORT V (90-95)									
1.8 D	Diesel	44	RTA;RTE;RTF;RTH	MTM	07/90-12/94		DAN504	14	70
1.8 D	Diesel	44	RTE;RTF;RTH		07/90-01/95		DAN504	14	70
1.8 D	Diesel	44	RTH	MTM	07/90-01/95	+ AC	DAN504	14	70
1.8 TD	Diesel	66	RFD	MTM	06/93-01/95	+ PS	DAN504	14	70
1.8 TD	Diesel	66	RFD;RFK		08/93-01/95		DAN504	14	70
ESCORT VI (95-01)									
1.8 D	Diesel	44	RTE;RTF;RTH		01/95-12/96		DAN504	14	70
1.8 D	Diesel	44	RTE;RTF;RTH		01/97-08/00		DAN047	14	70
1.8 TD	Diesel	66	RFD;RFK;RFN;RFS		01/95-12/96		DAN504	14	70
1.8 TD	Diesel	66	RFD;RFK;RFN;RFS		01/97-08/00		DAN047	14	70
1.8 Turbo D	Diesel	51	RVA		12/95-12/96		DAN504	14	70
1.8 Turbo D	Diesel	51	RVA		01/97-06/01		DAN047	14	70
FIESTA III (89-97)									
1.8 D	Diesel	44	RTC;RTD;RTG	MTM	03/89-12/95		DAN504	14	70
1.8 D	Diesel	44	RTC;RTD;RTG		09/91-02/96		DAN504	14	70
1.8 TD	Diesel	55	RFL		03/93-12/95		DAN504	14	70
FIESTA IV (95-03)									
1.8 D	Diesel	44	RTJ	MTM	08/95-04/00		DAN047	14	70
1.8 D	Diesel	44	RTJ;RTK		02/96-06/01		DAN047	14	70

										
FORD continued										
FIESTA V (01-08)										
1.25 16V	Petrol	51/55	FUJA;FUJB;M7JA;M7JB			01/05-06/08		DAN588	14	105
1.4 16V	Petrol	59	FXJA;FXJB			04/03-06/08		DAN588	14	105
1.6 16V	Petrol	74	FYJA;FYJB			04/03-06/08		DAN588	14	105
1.6 TDCi	Diesel	66	HHJA;HHJB			11/04-06/08		DAN1119	14	120
1.6 TDCi	Diesel	66	HHJA;HHJB			11/04-06/08		DAN930	14	150
FIESTA VI (08-)										
1.0	Petrol	48/59	P4JA;P4JB;P4JC; P4JD;XMJA;XMJB; XMJC;XMJD			10/12-	- EAH	DAN1312	14	120
1.0	Petrol	48/59	P4JA;P4JB;P4JC; P4JD;XMJA;XMJB; XMJC;XMJD			10/12-	+ EAH	DAN1073	14	150
1.0 EcoBoost	Petrol	74/92	M1JE;M1JH;SFJA; SFJB;SFJC;SFJD			09/12-	- EAH	DAN1312	14	120
1.0 EcoBoost	Petrol	74/92	M1JE;M1JH;SFJA; SFJB;SFJC;SFJD			09/12-	+ EAH	DAN1074	14	150
1.0 Sport	Petrol	103	YYJA;YYJB	5MTM		05/14-		DAN1073	14	150
FOCUS C-MAX (03-07)										
1.6	Petrol	74	HWDA;HWDB;SHDA; SHDB;SHDC			10/03-03/07		DAN588	14	105
1.6	Petrol	74	HWDA;HWDB;SHDA; SHDB;SHDC			08/04-03/07	+ Ho	DAN1041	14	120
1.6 TDCi	Diesel	66/80	G8DA;G8DB;G8DD; G8DE;G8DF;HHDA;HHDB			10/03-03/07		DAN1119	14	120
1.6 TDCi	Diesel	66/80	G8DA;G8DB;G8DD; G8DE;G8DF;HHDA;HHDB			10/03-03/07		DAN930	14	150
1.6 Ti	Petrol	85	HXDA;SIDA			08/04-03/07		DAN588	14	105
1.6 Ti	Petrol	85	HXDA;SIDA			08/04-03/07	+ Ho	DAN1041	14	120
1.8	Petrol	88/90/92	CSDA;CSDB;Q7DA; QQDA;QQDB;QQDC	MTM		10/03-03/07	TRN: MTX75	DAN1016	14	120
1.8	Petrol	88/90/92	CSDA;CSDB;Q7DA; QQDA;QQDB;QQDC	MTM		04/04-03/07	TRN: B5/IB5	DAN1023	14	120
1.8	Petrol	88/90/92	CSDA;CSDB;Q7DA; QQDA;QQDB;QQDC	ATM		05/05-03/07		DAN1023	14	120
1.8 FlexFuel	Flexfuel	92	Q7DA	ATM		01/06-03/07		DAN1023	14	120
1.8 FlexFuel	Flexfuel	92	Q7DA	MTM		01/06-03/07	TRN: B5/IB5	DAN1023	14	120
1.8 FlexFuel	Flexfuel	92	Q7DA	MTM		01/06-03/07	TRN: MTX75	DAN1016	14	120
1.8 TDCi	Diesel	85	KKDA;KKDB			01/05-03/07	- AC;+ EAH;+ PH; + HWS	DAN933	14	150
1.8 TDCi	Diesel	85	KKDA;KKDB			01/05-03/07	+ AC;- EAH;- PH	DAN582	14	105
1.8 TDCi	Diesel	85	KKDA;KKDB			01/05-03/07	+ AC;+ EAH;+ PH	DAN932	14	150
2.0	Petrol	107	AODA;AODB;AODE; SYDA	MTM		03/04-03/07		DAN1016	14	120
2.0	Petrol	107	AODA;AODB;AODE; SYDA	ATM		02/05-03/07		DAN1023	14	120
2.0	Petrol	107	AODA;AODB;AODE; SYDA	ATM		10/05-03/07	+ Ho	DAN931	14	150
2.0 TDCi	Diesel	98/100	G6DA;G6DB;G6DC; G6DD;G6DE;G6DF;G6DG			10/03-03/07		DAN1119	14	120
2.0 TDCi	Diesel	98/100	G6DA;G6DB;G6DC; G6DD;G6DE;G6DF;G6DG			10/03-03/07		DAN930	14	150
FOCUS I (98-05)										
1.4 16V	Petrol	55	FXDA;FXDB;FXDC; FXDD			10/98-11/04		DAN588	14	105
1.6 16V	Petrol	74	FYDA;FYDB;FYDC; FYDD;FYDH			10/98-11/04		DAN588	14	105
1.6 16V FlexFuel	Flexfuel	75	FYDH			01/02-11/04		DAN588	14	105
1.8 16V	Petrol	85	EYDB;EYDC;EYDD; EYDE;EYDF;EYDG; EYDI;EYDJ;EYDL			10/98-11/04		DAN562	14	90
1.8 BiFuel	Petrol/ Liquified Petroleum Gas (LPG)	82	EYDL			02/03-01/05		DAN562	14	90
1.8 DI	Diesel	55	BHDA;BHDB			08/99-11/04		DAN1124	14	90
1.8 TDCi	Diesel	74/85	F9DA;F9DB;FFDA			03/01-11/04		DAN1124	14	90
1.8 TDDi	Diesel	55/66	BHDA;BHDB;C9DA; C9DB;C9DC			10/98-03/05		DAN1124	14	90
2.0 16V	Petrol	96	EDDB;EDDC;EDDD; EDDF			10/98-11/04		DAN562	14	90
2.0 RS	Petrol	158	HMDA			10/02-11/04		DAN562	14	90
FOCUS II (04-12)										
1.4	Petrol	59	ASDA;ASDB			07/04-08/11		DAN588	14	105

Starters & Alternators











Application Tables - Alternators











			 kW							A
FORD continued										
FOCUS II (04-12) continued										
1.4	Petrol	59	ASDA;ASDB		07/04-08/11	+ Ho		DAN1041	14	120
1.6	Petrol	74	HWDA;HWDB;SHDA;SHDB;SHDC		07/04-09/12			DAN588	14	105
1.6	Petrol	74	HWDA;HWDB;SHDA;SHDB;SHDC		07/04-09/12	+ Ho		DAN1041	14	120
1.6 LPG	Petrol/ Liquified Petrol Gas (LPG)	85	SIDA		10/09-08/11			DAN588	14	105
1.6 LPG	Petrol/ Liquified Petrol Gas (LPG)	85	SIDA		10/09-08/11	+ Ho		DAN1041	14	120
1.6 TDCi	Diesel	66/74/80	G8DA;G8DB;G8DC; G8DD;G8DE;G8DF; GPDA;GPDB;GPDC; HHDA;HHDB;MTDA		07/04-12/09			DAN1119	14	120
1.6 TDCi	Diesel	66/74/80	G8DA;G8DB;G8DC; G8DD;G8DE;G8DF; GPDA;GPDB;GPDC; HHDA;HHDB;MTDA		07/04-12/09			DAN930	14	150
1.6 TDCi	Diesel	66/74/80	G8DA;G8DB;G8DC; G8DD;G8DE;G8DF; GPDA;GPDB;GPDC; HHDA;HHDB;MTDA		01/10-08/11			DAN1139	14	120
1.6 TDCi	Diesel	66/74/80	G8DA;G8DB;G8DC; G8DD;G8DE;G8DF; GPDA;GPDB;GPDC; HHDA;HHDB;MTDA		01/10-08/11			DAN1118	14	150
1.6 Ti	Petrol	85	HXDA;HXDB;SIDA		07/04-09/12			DAN588	14	105
1.6 Ti	Petrol	85	HXDA;HXDB;SIDA		07/04-09/12	+ Ho		DAN1041	14	120
1.8	Petrol	92	Q7DA;QQDA;QQDB		03/06-09/12			DAN1023	14	120
1.8	Petrol	92	Q7DA;QQDA;QQDB	MTM	03/06-09/12	TRN: MTX75		DAN1016	14	120
1.8 FlexFuel	Flexfuel	92	Q7DA;QQDA;QQDB	MTM	01/06-01/08	TRN: MTX75		DAN1016	14	120
1.8 FlexFuel	Flexfuel	92	Q7DA;QQDA;QQDB		01/06-08/11			DAN1023	14	120
1.8 TDCi	Diesel	85	KKDA		07/04-09/12	- AC;+ EAH;+ PH; + HWS		DAN933	14	150
1.8 TDCi	Diesel	85	KKDA		07/04-09/12	+ AC;- EAH;- PH		DAN582	14	105
1.8 TDCi	Diesel	85	KKDA		07/04-09/12	+ AC;+ EAH;+ PH		DAN932	14	150
2.0	Petrol	104/107	AODA;AOB;AODE; SYDA	MTM	07/04-09/12			DAN1016	14	120
2.0	Petrol	107	AODA;AOB;AODE; SYDA	MTM	07/04-09/12	+ Ho		DAN934	14	150
2.0	Petrol	107	AODA;AOB;AODE; SYDA	ATM	02/05-09/12			DAN1023	14	120
2.0	Petrol	107	AODA;AOB;AODE; SYDA	ATM	10/05-09/12	+ Ho		DAN931	14	150
2.0 CNG	Petrol/ Compressed Natural Gas (CNG)	107	SYDA	ATM	04/09-07/11			DAN1023	14	120
2.0 CNG	Petrol/ Compressed Natural Gas (CNG)	107	SYDA	MTM	04/09-07/11			DAN1016	14	120
2.0 CNG	Petrol/ Compressed Natural Gas (CNG)	107	SYDA	ATM	04/09-07/11	+ Ho		DAN931	14	150
2.0 CNG	Petrol/ Compressed Natural Gas (CNG)	107	SYDA	MTM	04/09-07/11	+ Ho		DAN934	14	150























A











FORD continued										
FOCUS II (04-12) continued										
2.0 Flex	Flexfuel	107	SYDA	MTM	10/08-03/10		DAN1016	14	120	
2.0 LPG	Petrol/ Liquified Petroleum Gas (LPG)	107	SYDA	ATM	06/08-07/11		DAN1023	14	120	
2.0 LPG	Petrol/ Liquified Petroleum Gas (LPG)	107	SYDA	MTM	06/08-07/11		DAN1016	14	120	
2.0 LPG	Petrol/ Liquified Petroleum Gas (LPG)	107	SYDA	ATM	06/08-07/11	+ Ho	DAN931	14	150	
2.0 LPG	Petrol/ Liquified Petroleum Gas (LPG)	107	SYDA	MTM	08/08-07/11	+ Ho	DAN934	14	150	
2.0 TDCi	Diesel	81/98/ 100	G6DA;G6DB;G6DD; G6DE;G6DF;G6DG;IXDA		07/04-08/11		DAN1119	14	120	
2.0 TDCi	Diesel	81/98/ 100	G6DA;G6DB;G6DD; G6DE;G6DF;G6DG;IXDA		07/04-08/11		DAN930	14	150	
2.5 RS	Petrol	224	JZDA		01/09-07/11		DAN1059	14	150	
2.5 RS 500	Petrol	257	JZDA		05/10-07/11		DAN1059	14	150	
2.5 ST	Petrol	166	HYDA		10/05-07/11		DAN1059	14	150	
FOCUS III (10-)										
1.0 EcoBoost	Petrol	74	M2DA;M2DB;M2DC; SFDA;SFDB	5MTM	02/12-06/12		DAN1073	14	150	
1.0 EcoBoost	Petrol	74	M2DA;M2DB;M2DC; SFDA;SFDB	5MTM	07/12-	- EAH;- PH	DAN1312	14	120	
1.0 EcoBoost	Petrol	74	M2DA;M2DB;M2DC; SFDA;SFDB	5MTM	07/12-	+ EAH;+ PH	DAN1073	14	150	
1.0 EcoBoost	Petrol	92	M1DA;M1DC;M1DD	6MTM	02/12-06/12		DAN1074	14	150	
1.0 EcoBoost	Petrol	92	M1DA;M1DC;M1DD	6MTM	07/12-	- EAH;- PH	DAN1313	14	120	
1.0 EcoBoost	Petrol	92	M1DA;M1DC;M1DD	6MTM	07/12-	+ EAH;+ PH	DAN1074	14	150	
FUSION (02-12)										
1.25	Petrol	55	FUJA;FUJB		01/05-12/12		DAN588	14	105	
1.4	Petrol	59	FXJA;FXJB;FXJC		04/03-12/12		DAN588	14	105	
1.4 LPG	Petrol/ Liquified Petroleum Gas (LPG)	59	UTJA		01/10-12/12		DAN588	14	105	
1.6	Petrol	74	FYJA;FYJB;FYJC		04/03-11/09		DAN588	14	105	
1.6 TDCi	Diesel	66	HHJA;HHJB		11/04-12/09		DAN1119	14	120	
1.6 TDCi	Diesel	66	HHJA;HHJB		11/04-12/09		DAN930	14	150	
1.6 TDCi	Diesel	66	HHJA;HHJB		01/10-06/12		DAN1139	14	120	
1.6 TDCi	Diesel	66	HHJA;HHJB		01/10-06/12		DAN1118	14	150	
Grand C-MAX (10-)										
1.0 EcoBoost	Petrol	74/92	B3DA;B7DA;M1DA; M1DD;M2DA;M2DC	MTM	10/12-	- EAH;- PH	DAN1313	14	120	
1.0 EcoBoost	Petrol	74/92	B3DA;B7DA;M1DA; M1DD;M2DA;M2DC	MTM	10/12-	+ EAH;+ PH	DAN1074	14	150	
KA (08-16)										
1.2	Petrol	51	169A4000;FP4		10/08-10/10	- AC	DAN998	14	70	
1.2	Petrol	51	169A4000;FP4		10/08-10/10	- AC;+ Co;+ Ho	DAN1004	14	90	
1.2	Petrol	51	169A4000;FP4		10/08-10/10	+ AC	DAN519	14	90	
1.2	Petrol	51	169A4000;FP4		10/08-10/10	+ AC;+ Co;+ Ho	DAN599	14	105	
1.2	Petrol	51	169A4000;FP4		11/10-05/16	- AC	DAN1005	14	105	
1.2	Petrol	51	169A4000;FP4		11/10-05/16	+ AC	DAN999	14	120	
1.3 TDCi	Diesel	55	169A1000;FD4		10/08-11/10	- AC	DAN1003	14	70	
1.3 TDCi	Diesel	55	169A1000;FD4		10/08-11/10	- AC;+ Co;+ Ho	DAN1001	14	105	
1.3 TDCi	Diesel	55	169A1000;FD4		10/08-11/10	+ AC	DAN1002	14	90	
1.3 TDCi	Diesel	55	169A1000;FD4		10/08-11/10	+ AC;+ Co;+ Ho	DAN997	14	120	
KUGA I (08-12)										
2.0 TDCi	Diesel	100/103	G6DG;UFDA;UKDA		03/08-11/12	EU4	DAN930	14	150	
2.0 TDCi	Diesel	100/103	G6DG;UFDA;UKDA		05/10-11/12	EU5	DAN1118	14	150	
2.0 TDCi 4x4	Diesel	100/103/ 120	G6DG;TXDA;UFDA;UKDA		03/08-11/12	EU4	DAN930	14	150	

									
FORD continued									
KUGA I (08-12) continued									
2.0 TDCi 4x4	Diesel	100/103/120	G6DG;TXDA;UFDA;UKDA		05/10-11/12	EU5	DAN1118	14	150
MONDEO I (93-96)									
1.8 TD	Diesel	66	RFM;RFN		05/95-08/96		DAN504	14	70
ORION III (90-93)									
1.8 D	Diesel	44	RTE;RTF;RTH		11/90-12/93		DAN504	14	70
1.8 TD	Diesel	66	RFD;RFK		03/92-12/93		DAN504	14	70
TOURNEO Connect (13-)									
1.0 EcoBoost	Petrol	74	B3GA;M2GA;M2GB;SFCB		11/13-		DAN1074	14	150
TOURNEO Courier (14-)									
1.0 EcoBoost	Petrol	74	SFCA;SFCB;SFCC;SFCD;SFCE;SFCF		02/14-	- EAH	DAN1312	14	120
1.0 EcoBoost	Petrol	74	SFCA;SFCB;SFCC;SFCD;SFCE;SFCF		02/14-	+ EAH	DAN1073	14	150
TRANSIT Connect (13-)									
1.0 EcoBoost	Petrol	74	B3GA;M2GA;M2GB		02/13-		DAN1074	14	150
TRANSIT Courier (14-)									
1.0 EcoBoost	Petrol	74	SFCA;SFCB;SFCC;SFCD;SFCE;SFCF		02/14-	- EAH	DAN1312	14	120
1.0 EcoBoost	Petrol	74	SFCA;SFCB;SFCC;SFCD;SFCE;SFCF		02/14-	+ EAH	DAN1073	14	150
HONDA									
ACCORD VII (03-08)									
2.0	Petrol	114	K20A6		02/03-05/08		DAN1375	14	105
2.0 4WD	Petrol	114	K20A6		02/03-05/08		DAN1375	14	105
2.2 i-CTDi	Diesel	103	N22A1		01/04-05/08		DAN985	14	105
2.4	Petrol	140	K24A3		02/03-05/08		DAN1375	14	105
ACCORD VIII (08-)									
2.0 i	Petrol	115	R20A3		06/08-06/15		DAN1148	14	105
2.0 i-VTEC	Petrol	114	R20A3		07/08-09/12		DAN1148	14	105
2.4 i	Petrol	148	K24Z3		07/08-		DAN1376	14	105
CIVIC IX (11-)									
1.6 i-DTEC	Diesel	88	N16A1		02/13-		DAN1326	14	150
CIVIC VIII Hatchback (05-)									
2.0 Type R	Petrol	148	K20Z4		09/06-		DAN1375	14	105
2.2 CTDi	Diesel	103	N22A2		09/05-		DAN985	14	105
CIVIC VIII Saloon (05-)									
1.8	Petrol	103	R18A1		05/06-01/12		DAN1375	14	105
CR-V II (01-06)									
2.2 CTDi	Diesel	103	N22A2		02/05-09/06		DAN985	14	105
CR-V III (06-)									
2.0 i-VTEC 4WD	Petrol	110	R20A1;R20A2		10/06-06/12		DAN1148	14	105
2.2 i-CTDi 4WD	Diesel	103	N22A2		01/07-		DAN985	14	105
2.4 4WD	Petrol	124	K24Z1		09/06-		DAN1375	14	105
2.4 i-VTEC 4WD	Petrol	118/122/125	K24Z1;K24Z4		10/06-		DAN1375	14	105
CR-V IV (12-)									
1.6 i-DTEC	Diesel	88	N16A1		10/13-		DAN1326	14	150
1.6 i-DTEC 4WD	Diesel	118	N16A4		02/15-		DAN1326	14	150
2.0	Petrol	114	R20A5;R20A6;R20A9		10/12-		DAN1370	14	105
2.0 4WD	Petrol	114	R20A6;R20A9		10/12-		DAN1370	14	105
2.0 Flex	Flexfuel	114	R20A1		01/13-		DAN1370	14	105
FR-V (04-)									
2.2 i CTDi	Diesel	103	N22A1		07/05-		DAN985	14	105
HR-V (14-)									
1.6 i-DTEC	Diesel	88	N16A3		08/15-		DAN1326	14	150
HYUNDAI									
Grand SANTA FÉ III (13-)									
2.2 CRDi AWD	Diesel	145	D4HB		06/13-		DAN1102	14	150
ix35 (09-)									
2.0 CRDi	Diesel	100/135	D4HA	ATM	01/10-		DAN1102	14	150
2.0 CRDi 4WD	Diesel	100/135	D4HA	ATM	01/10-	EUR	DAN1102	14	150
SANTA FÉ II (06-13)									
2.2 CRDi	Diesel	145	D4HB	ATM	01/09-12/12		DAN1102	14	150
2.2 CRDi 4x4	Diesel	145	D4HB	ATM	01/09-12/12		DAN1102	14	150
SANTA FÉ III (12-)									
2.0 CRDi	Diesel	110	D4HA	ATM	09/12-		DAN1102	14	150
2.0 CRDi 4WD	Diesel	110	D4HA	ATM	09/12-		DAN1102	14	150
2.2 CRDi	Diesel	145	D4HB	ATM	09/12-12/15		DAN1102	14	150
2.2 CRDi 4WD	Diesel	145	D4HB	ATM	09/12-12/15		DAN1102	14	150

									
ISUZU									
D-MAX I (02-12)									
2.5 DiTD	Diesel	100	4JK1-TC		10/06-06/12		DAN1487	14	90
2.5 DiTD 4x4	Diesel	100	4JK1-TC		01/07-06/12		DAN1487	14	90
3.0 DiTD	Diesel	120	4JJ1E4C-L;4JJ1-TC		01/07-06/12		DAN1487	14	90
D-MAX II (12-)									
2.5 CRDi	Diesel	120	4JK1E5S-L; 4JK-1E5-TC;4JK1-TCY		06/12-		DAN1487	14	90
2.5 CRDi 4WD	Diesel	120	4JK1-TCY		06/12-		DAN1487	14	90
2.5 CRDi 4x4	Diesel	120	4JK1E5S-L;4JK-1E5-TC		06/12-		DAN1487	14	90
TROOPER III (98-04)									
3.5 V6 24V	Petrol	158	6VE1		04/00-08/04		DAN1488	14	90
3.5 V6 24V AWD	Petrol	158	6VE1		04/00-08/04		DAN1488	14	90
JAGUAR									
F-PAGE (15-)									
3.0 SCV6 AWD	Petrol	250/280	306PS		09/15-		DAN1103	14	150
5.0 SCV8 SVR AWD	Petrol	405	508PS		08/18-		DAN1103	14	150
F-TYPE (12-)									
3.0 SCV6	Petrol	250	306PS		10/12-		DAN1103	14	150
3.0 SCV6 400 SPORT	Petrol	294	306PS		11/16-		DAN1103	14	150
3.0 SCV6 400 SPORT AWD	Petrol	294	306PS		11/16-		DAN1103	14	150
3.0 SCV6 S	Petrol	280	306PS		10/12-		DAN1103	14	150
3.0 SCV6 S AWD	Petrol	280	306PS		12/14-		DAN1103	14	150
5.0 SCV8 R	Petrol	405	508PS		10/13-		DAN1103	14	150
5.0 SCV8 R AWD	Petrol	405	508PS		12/14-		DAN1103	14	150
5.0 SCV8 S	Petrol	364	508PS		10/12-		DAN1103	14	150
5.0 SCV8 SVR	Petrol	423	508PS		05/15-		DAN1103	14	150
5.0 SCV8 SVR / SCV8 P575 R	Petrol	423	508PS;AJ133G2		12/15-		DAN1103	14	150
5.0 SCV8 SVR / SCV8 P575 R AWD	Petrol	423	508PS;AJ133G2		12/15-		DAN1103	14	150
S-TYPE (99-08)									
2.5 V6	Petrol	147	AJ25;JB (AJ-V6)	ATM	04/02-10/07	Ch No: M45255>	DAN1408	14	120
3.0 V6	Petrol	175	AJ-V6;FB	ATM	04/02-10/07	Ch No: M45255>	DAN1408	14	120
XE (15-)									
3.0 S	Petrol	250/280	306PS		03/15-		DAN1103	14	150
5.0 SVO PROJECT 8	Petrol	441	508PS		03/18-		DAN1103	14	150
XF (08-15)									
2.0	Petrol	177	204PT		06/12-04/15		DAN1203	14	180
2.2 D	Diesel	120/140/ 147	224DT		04/11-04/15		DAN1111	14	180
3.0	Petrol	250	306PS		03/12-04/15		DAN1103	14	150
3.0 AWD	Petrol	250	306PS		10/12-04/15		DAN1103	14	150
4.2	Petrol	219	SV82G		03/08-04/15		DAN1201	14	130
4.2 Kompressor	Petrol	306	SV8TS		03/08-04/15		DAN1201	14	130
5.0	Petrol	283	508PN		03/09-04/15		DAN1103	14	150
5.0 Kompressor	Petrol	346/375/ 380	508PS		01/09-04/15		DAN1103	14	150
5.0 XFR-S	Petrol	405	508PS		10/12-04/15		DAN1103	14	150
XF (15-)									
3.0	Petrol	250/280	306PS		05/15-		DAN1103	14	150
3.0 AWD	Petrol	250/280	306PS		07/15-		DAN1103	14	150
XJ (94-97)									
6.0 V12	Petrol	229	8E10		09/94-09/97		DAN671	14	120
XJ (97-03)									
3.2	Petrol	174			07/97-05/03		DAN672	14	120
4.0	Petrol	209/216/ 267	AJ-V8;BC;DC		07/97-05/03		DAN672	14	120
XJ (03-09)									
3.0	Petrol	175/179	AJ-V6	ATM	05/03-03/09		DAN1408	14	120
XJ (09-)									
2.0 Ti4	Petrol	177	204PT		05/12-		DAN1202	14	220
5.0 SCV8	Petrol	346/375/ 405	508PS		10/09-		DAN1103	14	150
5.0 SCV8 R575	Petrol	423	508PS		06/17-		DAN1103	14	150
5.0 V8	Petrol	283	508PN		10/09-		DAN1103	14	150
XK 8 (96-05)									
4.0	Petrol	209/216/ 267	AJ26;AJ27;AJ-V8;CC; CE;EC		03/96-07/05		DAN672	14	120
4.0 XKR	Petrol	276	AJ27S		05/98-07/05		DAN672	14	120
XK (06-14)									
5.0 V8	Petrol	283	508PN		01/09-07/14		DAN1103	14	150
5.0 XKR	Petrol	375/390	508PS		01/09-07/14		DAN1103	14	150

									
JAGUAR continued									
XK (06-14) continued									
5.0 XKR-S	Petrol	405	508PS		01/11-07/14		DAN1103	14	150
X-TYPE (01-09)									
2.1 V6	Petrol	115	YB (AJ-V6)	ATM	03/02-11/09		DAN1407	14	120
2.5	Petrol	144	XB (AJ-V6)	ATM	02/04-12/09		DAN1407	14	120
2.5 V6 AWD	Petrol	144	XB (AJ-V6)	ATM	06/01-11/09		DAN1407	14	120
3.0	Petrol	169	AJ-V6	ATM	02/04-12/09		DAN1407	14	120
3.0 V6 AWD	Petrol	169	AJ-V6	ATM	06/01-12/08		DAN1407	14	120
JEEP									
RENEGADE (14-)									
1.4	Petrol	103	552 63 624;EAM		07/14-		DAN1078	14	120
1.4	Petrol	103	552 63 624;EAM		07/14-	+ Co;+ Ho	DAN1332	14	150
1.4 4x4	Petrol	125	552 63 623;EAM		07/14-		DAN1332	14	150
1.6 CRD	Diesel	88	552 63 113;552 80 444; EJK		07/14-		DAN1121	14	120
1.6 CRD	Diesel	88	552 63 113;552 80 444; EJK		07/14-	+ Co;+ Ho	DAN1146	14	150
2.0 CRD 4x4	Diesel	88/103/125	552 63 087;552 63 088; 552 83 099;552 84 064; EBT		07/14-		DAN1121	14	120
2.0 CRD 4x4	Diesel	88/103/125	552 63 087;552 63 088; 552 83 099;552 84 064; EBT		07/14-	+ Co;+ Ho	DAN1146	14	150
KIA									
CARNIVAL III (06-)									
2.2 CRDi	Diesel	110/143	D4HB	ATM	01/10-		DAN1102	14	150
SORENTO II (09-)									
2.0 CRDi	Diesel	110	D4HA		11/10-		DAN1102	14	150
2.0 CRDi 4WD	Diesel	110	D4HA		11/10-		DAN1102	14	150
2.2 CRDi	Diesel	145	D4HB	ATM	11/09-		DAN1102	14	150
2.2 CRDi 4WD	Diesel	145	D4HB	ATM	11/09-		DAN1102	14	150
SPORTAGE III (10-)									
2.0 CRDi	Diesel	100	D4HA		07/10-05/14		DAN1102	14	150
2.0 CRDi AWD	Diesel	100/135	D4HA	ATM	07/10-	EUR	DAN1102	14	150
LANCIA									
DEDRA (89-99)									
1.8 16V LE	Petrol	83	182 A2.000		03/96-07/99		DAN632	14	100
1.8 GT 16V	Petrol	96	183 A1.000		03/96-07/99		DAN632	14	100
1.8 i.e.	Petrol	66/74/77/80	835 A2.000;835 A2.046; 835 C5.000;836 A5.000	MTM	09/89-07/99		DAN615	14	65
DELTA II (93-99)									
1.8 i.e.	Petrol	66/76	835 C2.000;835 C4.000; 836 A6.000;836 C4.000	MTM	11/93-08/96		DAN615	14	65
1.8 i.e. 16V	Petrol	83	182 A2.000		03/96-08/99		DAN632	14	100
1.8 i.e. 16V GT	Petrol	96	183 A1.000		03/96-08/99	Eng No: >1385143	DAN632	14	100
1.8 i.e. 16V GT	Petrol	96	183 A1.000		03/96-08/99	Eng No: 1385143>	DAN1140	14	105
DELTA III (08-14)									
1.4	Petrol	88/110	198 A1.000;198 A4.000		09/08-08/14		DAN993	14	120
1.4 16V	Petrol	103	198 A7.000		07/10-08/14		DAN993	14	120
1.4 BiFuel	Petrol/ Liquified Petroleum Gas (LPG)	88	940 B7.000		07/11-08/14		DAN993	14	120
1.6 D Multijet	Diesel	77/85/88	198 A2.000; 944 A 3.000;955 A4.000		12/09-08/14		DAN1147	14	100
1.6 D Multijet	Diesel	77/85/88	198 A2.000; 944 A 3.000;955 A4.000		12/09-08/14	+ Co	DAN1084	14	120
1.6 D Multijet	Diesel	85/88	198 A2.000;955 A4.000		08/08-12/09		DAN994	14	100
1.6 D Multijet	Diesel	85/88	198 A2.000;955 A4.000		08/08-12/09	+ Co	DAN995	14	120
1.6 D Multijet	Diesel	85/88	198 A2.000;955 A4.000		08/08-08/14	+ FDC	DAN1062	14	140
1.8	Petrol	147	939 B1.000		01/09-08/14		DAN1000	14	120
1.9 D Multijet	Diesel	140	844 A1.000		01/09-12/09		DAN994	14	100
1.9 D Multijet	Diesel	140	844 A1.000		01/09-12/09	+ Co	DAN995	14	120
1.9 D Multijet	Diesel	140	844 A1.000		01/09-08/14	+ FDC	DAN1062	14	140
1.9 D Multijet	Diesel	140	844 A1.000		12/09-08/14		DAN1147	14	100
1.9 D Multijet	Diesel	140	844 A1.000		12/09-08/14	+ Co	DAN1084	14	120
2.0 D Multijet	Diesel	121	198 A5.000;198 A8.000; 844 A2.000		09/08-12/09		DAN994	14	100
2.0 D Multijet	Diesel	121	198 A5.000;198 A8.000; 844 A2.000		09/08-12/09	+ Co	DAN995	14	120











									
LANCIA continued									
DELTA III (08-14) continued									
2.0 D Multijet	Diesel	121	198 A5.000;198 A8.000; 844 A2.000		09/08-08/14	+ FDC	DAN1062	14	140
2.0 D Multijet	Diesel	121	198 A5.000;198 A8.000; 844 A2.000		12/09-08/14		DAN1147	14	100
2.0 D Multijet	Diesel	121	198 A5.000;198 A8.000; 844 A2.000		12/09-08/14	+ Co	DAN1084	14	120
KAPPA (94-01)									
2.0 20V	Petrol	107/114	838 A1.000;838 A6.000		10/94-10/01		DAN1140	14	105
2.4 20V	Petrol	129	838 A2.000;838 A2.027		08/94-10/01		DAN1140	14	105
2.4 JTD	Diesel	100	838 A8.000		06/98-10/01		DAN1140	14	105
2.4 JTD	Diesel	100	838 A8.000		06/98-10/01		DAN501	14	105
2.4 T.DS	Diesel	91	838 A3.000;838 A7.000		08/94-10/01		DAN1140	14	105
LYBRA (99-05)									
1.8 16V	Petrol	96	839 A4.000;839 A7.000; 839 A9.000		07/99-02/02		DAN502	14	120
1.8 16V	Petrol	96	839 A4.000;839 A7.000; 839 A9.000		07/99-02/02	Eng No: >2850151	DAN1140	14	105
1.9 JTD	Diesel	77	AR 32302		07/99-10/99	Eng No: >1611909;- AC	DAN1037	14	90
1.9 JTD	Diesel	77	AR 32302		07/99-10/99	Eng No: >1611909;+ AC	DAN1140	14	105
1.9 JTD	Diesel	77	AR 32302		07/99-09/01	+ EH	DAN502	14	120
1.9 JTD	Diesel	77	AR 32302		10/99-09/01	Eng No: >1611909;- AC	DAN501	14	105
1.9 JTD	Diesel	77	AR 32302		10/99-09/01	Eng No: 1611909>;+ AC	DAN502	14	120
1.9 JTD	Diesel	81/85	937 A2.000;AR 37101		09/00-10/05	- AC	DAN501	14	105
1.9 JTD	Diesel	81/85	937 A2.000;AR 37101		09/00-10/05	+ AC	DAN502	14	120
2.4 JTD	Diesel	99	839 A5.000;AR 32501		07/99-09/99	Eng No: >1611909	DAN1140	14	105
2.4 JTD	Diesel	99	839 A5.000;AR 32501		09/99-02/01	Eng No: 1611909>	DAN502	14	120
2.4 JTD	Diesel	103/110	839 A6.000;841 C.000		09/00-10/05		DAN502	14	120
MUSA (04-12)									
1.3 D Multijet	Diesel	51/66	188 A9.000;199 A3.000		10/04-12/10	+ AC	DAN1002	14	90
1.3 D Multijet	Diesel	51/66	188 A9.000;199 A3.000		10/04-12/10	+ AC;+ Co	DAN997	14	120
1.3 D Multijet	Diesel	66	199 A3.000		09/06-12/10	- AC	DAN1003	14	70
1.3 D Multijet	Diesel	70	199 B1.000		03/09-09/12	- SS	DAN1002	14	90
1.3 D Multijet	Diesel	70	199 B1.000		03/09-09/12	+ SS	DAN997	14	120
1.4	Petrol	57	350 A1.000		09/05-09/12		DAN517	14	70
1.4	Petrol	66	192 B2.000		10/07-09/12	- SS	DAN519	14	90
1.4	Petrol	66	192 B2.000		10/07-09/12	+ SS	DAN999	14	120
1.4	Petrol	70	843 A 1.000		10/04-09/12		DAN519	14	90
1.4 LPG	Petrol/ Liquified Petroleum Gas (LPG)	57	350 A1.000		11/10-09/12		DAN517	14	70
1.6 D Multijet	Diesel	85/88	350 A2.000;350 A3.000		07/08-09/12	- SS	DAN994	14	100
1.6 D Multijet	Diesel	85/88	350 A2.000;350 A3.000		07/08-09/12	+ SS	DAN995	14	120
1.9 D Multijet	Diesel	74	188 B2.000		10/04-06/06		DAN501	14	105
1.9 D Multijet	Diesel	74	188 B2.000		10/04-06/06	+ Co	DAN502	14	120
1.9 D Multijet	Diesel	74	188 B2.000		06/06-09/12		DAN1365	14	90
PHEDRA (02-10)									
2.0	Petrol	100	RFN (EW10J4)		09/02-11/10		DAN1336	14	90
THEMA (84-94)									
2000 i.e	Petrol	86	834 B1.000	MTM	09/88-10/89		DAN615	14	65
2000 i.e.	Petrol	83/85/88	834 B.000;834 B.048; 834 B.146	MTM	11/84-05/92		DAN615	14	65
2000 i.e. Turbo	Petrol	110	834 C.146	MTM	07/86-05/90		DAN615	14	65
Y (95-03)									
1.1	Petrol	40	176 B2.000		11/95-09/03	+ AC	DAN629	14	90
1.1	Petrol	40	176 B2.000		11/95-09/03	+ AC;+ PS	DAN629	14	90
1.2	Petrol	44	188 A4.000		06/00-09/03	+ AC	DAN517	14	70
1.2	Petrol	44	188 A4.000;840 A3.000		03/96-09/03	+ AC	DAN629	14	90
1.2	Petrol	44	188 A4.000;840 A3.000		03/96-09/03	+ AC;+ PS	DAN629	14	90
1.2	Petrol	44	840 A3.000		03/96-08/00	+ PS	DAN630	14	65
1.2 16V	Petrol	59	188 A5.000		10/00-09/03	+ AC	DAN517	14	70
1.2 16V	Petrol	63	176 B9.000		04/97-09/03	+ AC	DAN629	14	90
1.4 12V	Petrol	55/59	840 A2.000;840 A4.000	MTM	03/96-09/03	+ AC	DAN1037	14	90
YPSILON (312/846) (11-)									
0.9 CNG	Petrol/ Compressed Natural Gas (CNG)	63	312 A2.000		05/11-		DAN993	14	120

									
LANCIA continued									
YPSILON (312/846) (11-) continued									
0.9 TwinAir	Petrol	59/63	312 A2.000;312 A5.000		05/11-		DAN1078	14	120
1.2	Petrol	51	169 A4.000		05/11-	- AC	DAN1005	14	105
1.2	Petrol	51	169 A4.000		05/11-	+ AC	DAN999	14	120
1.2 BiFuel	Petrol/ Liquified Petrol Gas (LPG)	49	169 A4.000		05/11-	- AC	DAN517	14	70
1.2 BiFuel	Petrol/ Liquified Petrol Gas (LPG)	49	169 A4.000		05/11-	+ AC	DAN519	14	90
1.2 BiFuel	Petrol/ Liquified Petrol Gas (LPG)	51	169 A4.000		02/12-		DAN519	14	90
1.3 D Multijet	Diesel	70	199 B1.000;312 B1.000		05/11-	+ AC	DAN1086	14	120
YPSILON (843) (03-11)									
1.2	Petrol	44/51	169 A4.000;188 A4.000		10/03-12/11	- AC	DAN998	14	70
1.2	Petrol	44/51/59	169 A4.000;188 A4.000; 188 A5.000		10/03-12/11	+ AC	DAN519	14	90
1.3 D Multijet	Diesel	55/66	199 A2.000;199 A3.000		09/06-11/10	- AC	DAN1003	14	70
1.3 D Multijet	Diesel	55/66	199 A2.000;199 A3.000		09/06-11/10	+ AC	DAN1002	14	90
1.3 D Multijet	Diesel	77	199 A3.000		05/07-11/10		DAN1002	14	90
1.3 JTD	Diesel	51	188 A9.000		10/03-09/06	- AC	DAN1003	14	70
1.3 JTD	Diesel	51	188 A9.000		10/03-09/06	+ AC	DAN1002	14	90
1.4	Petrol	57	350 A1.000		02/06-12/11	- AC	DAN998	14	70
1.4	Petrol	57	350 A1.000		02/06-12/11	+ AC	DAN517	14	70
1.4 16V	Petrol	70	843 A 1.000		10/03-12/11	- AC	DAN998	14	70
1.4 16V	Petrol	70	843 A 1.000		10/03-12/11	+ AC	DAN519	14	90
1.4 LPG	Petrol/ Liquified Petrol Gas (LPG)	57	350 A1.000		11/10-12/11		DAN517	14	70
LAND ROVER									
DEFENDER (90-16)									
2.2 Td4 4x4	Diesel	90/110	DT224		08/11-02/16		DAN1104	14	150
2.5 Td5 4x4	Diesel	90	10 P;14 P;15 P		06/98-02/16	+ VP	DAN670	14	120
2.5 TDI 4x4	Diesel	83	16 L;23 L		08/90-12/98		DAN005	14	65
DISCOVERY II (98-04)									
2.5 Td5 4x4	Diesel	102	10 P;15 P		11/98-06/04	+ VP	DAN670	14	120
DISCOVERY III (04-09)									
2.7 TD 4x4	Diesel	140	276DT		07/04-09/09	Ch No: >9A999999	DAN987	14	150
4.0 4x4	Petrol	160	40VSER		02/05-09/09		DAN986	14	150
4.4 4x4	Petrol	220	448PN		07/04-09/09		DAN991	14	150
DISCOVERY IV (09-18)									
2.7 TD 4x4	Diesel	140	276DT		09/09-12/18	Ch No: AA000001>	DAN1106	14	150
3.0 4x4	Petrol	250	306PS		08/13-12/18		DAN1112	14	180
3.0 SDV6 4x4	Diesel	188	306DT		11/09-12/18		DAN1105	14	150
3.0 TD 4x4	Diesel	155/180/ 183/200	306DT		09/09-12/18		DAN1105	14	150
4.0 4x4	Petrol	160	406PN		09/09-12/18		DAN986	14	150
5.0 V8 4x4	Petrol	276	508PN		09/09-12/18		DAN1103	14	150
DISCOVERY V (16-)									
3.0 SCV6 4x4	Petrol	250	306PS		09/16-		DAN1112	14	180
FREELANDER I (98-06)									
1.8 16V 4x4	Petrol	86	18 K4F		04/98-10/06	- AC	DAN673	14	90
1.8 i 16V 4x4	Petrol	88	18 K4F		02/98-08/00	Ch No: >YA999999;+ AC	DAN674	14	105
1.8 i 16V 4x4	Petrol	88	18 K4F		02/98-10/06	- AC	DAN673	14	90
RANGE ROVER Evoque (11-19)									
2.2 D	Diesel	110	224DT		06/11-12/19	Ch No: >EH000001	DAN1111	14	180
2.2 D 4x4	Diesel	110/140	224DT		06/11-12/19	Ch No: >EH000001	DAN1111	14	180
RANGE ROVER III (02-12)									
3.6 D 4x4	Diesel	200	368DT		04/06-08/12		DAN989	14	150
4.2 4x4	Petrol	291	428PS		05/05-08/12	Ch No: 6A000001>9A999999	DAN991	14	150



A











LAND ROVER continued									
RANGE ROVER III (02-12) continued									
4.4 4x4	Petrol	220/225	448PN		08/04-08/12	Ch No: 6A000001>9A999999	DAN991	14	150
4.4 D 4x4	Diesel	230	448DT		07/10-08/12		DAN1110	14	220
5.0 4x4	Petrol	276/375	508PN;508PS		09/09-08/12		DAN1103	14	150
RANGE ROVER IV (12-)									
3.0 SCV6 4x4	Petrol	250/280	306PS		10/13-		DAN1112	14	180
4.4 SDV8 4x4	Diesel	250	448DT		08/12-		DAN1110	14	220
5.0 SCV8 4x4	Petrol	375/405	508PS		08/12-		DAN1112	14	180
5.0 V8 4x4	Petrol	276	508PN		12/13-		DAN1112	14	180
RANGE ROVER Sport (05-13)									
2.7 D 4x4	Diesel	140	276DT		02/05-03/13	Ch No: >9A999999;-ACE	DAN987	14	150
2.7 D 4x4	Diesel	140	276DT		02/05-03/13	Ch No: >9A999999;+ACE	DAN988	14	150
3.0 D 4x4	Diesel	155/180/183/188	306DT		09/09-03/13		DAN1105	14	150
3.6 D 4x4	Diesel	200	368DT		04/06-03/13	Ch No: 7A000001>	DAN990	14	150
4.2 4x4	Petrol	287	428PS		02/05-03/13	Ch No: >9A999999	DAN991	14	150
4.4 4x4	Petrol	220	448PN		02/05-03/13	Ch No: >9A999999	DAN991	14	150
5.0 4x4	Petrol	276/372/375	508PN;508PS		04/09-03/13		DAN1103	14	150
RANGE ROVER Sport (13-)									
3.0 SCV6 4x4	Petrol	250/280	306PS		04/13-12/19		DAN1112	14	180
4.4 SDV8 4x4	Diesel	250	448DT		10/13-		DAN1110	14	220
5.0 SCV8 4x4	Petrol	375/405	508PS		04/13-12/18		DAN1112	14	180
RANGE ROVER Velar (17-)									
3.0 P340 SCV6 4x4	Petrol	250	306PS		04/18-		DAN1103	14	150
3.0 P380 SCV6 4x4	Petrol	280	306PS		03/17-		DAN1103	14	150
LEXUS									
GS (05-11)									
300	Petrol	183	3GR-FSE		04/05-11/11		DAN1354	14	150
350	Petrol	223	2GR-FSE		04/05-12/12		DAN1483	14	150
350 AWD	Petrol	226	2GR-FSE		09/06-11/11		DAN1483	14	150
430	Petrol	208	3UZ-FE		04/05-09/08		DAN1279	14	130
GS (12-)									
250	Petrol	154	4GR-FSE		01/12-		DAN1483	14	150
350	Petrol	233	2GR-FSE		03/12-10/15		DAN1483	14	150
350 AWD	Petrol	234	2GR-FSE		12/11-10/15		DAN1483	14	150
GX (09-)									
470	Petrol	218	1UR-FE		01/10-		DAN1205	14	150
IS C (09-15)									
250	Petrol	153	4GR-FSE		04/09-06/15		DAN1354	14	150
300	Petrol	170	3GR-FE		11/10-06/15		DAN1483	14	150
IS II (05-13)									
200d	Diesel	110	2AD-FTV		07/10-08/12		DAN1013	14	130
220d	Diesel	130	2AD-FHV		08/05-08/12		DAN1013	14	130
250	Petrol	153	4GR-FSE		08/05-03/13		DAN1354	14	150
250 AWD	Petrol	158	4GR-FSE		11/10-03/13		DAN1354	14	150
300	Petrol	170	3GR-FE		04/06-03/13		DAN1483	14	150
350	Petrol	228	2GR-FSE		08/10-03/13		DAN1354	14	150
IS III (13-)									
250	Petrol	153	4GR-FSE		04/13-		DAN1483	14	150
350	Petrol	234	2GR-F		04/13-10/17		DAN1483	14	150
LS (00-06)									
430	Petrol	207	3UZ-FE		07/03-08/06		DAN1279	14	130
LS (06-17)									
460	Petrol	255/280/283	1UR-FE;1UR-FSE		04/06-09/12		DAN1281	14	180
460 AWD	Petrol	270	1UR-FSE		12/08-09/12		DAN1281	14	180
LX (07-)									
450d	Diesel	200	1VD-FTV		09/15-		DAN1209	14	180
570	Petrol	270	3UR-FE		11/07-		DAN1208	14	180
570	Petrol	270	3UR-FE		01/12-		DAN1205	14	150
RC (14-)									
350	Petrol	234	2GR-FSE		08/14-		DAN1483	14	150
MAZDA									
3 (00-09)									
1.6 DI Turbo	Diesel	80	Y601;Y603;Y605;Y642		06/04-06/09		DAN930	14	150
1.6 MZ-CD	Diesel	66	Y406		06/06-12/08		DAN1073	14	150









         										
MAZDA continued										
3 (09-14)										
1.6 MZ-CD	Diesel	80	Y642		12/08-03/10	Ch No: >197377	DAN930	14	150	
1.6 MZR CD	Diesel	80	Y642		12/08-03/10		DAN930	14	150	
121 III (96-03)										
1.8 D	Diesel	44	RTJ;RTK		03/96-04/03		DAN047	14	70	
MINI										
MINI (F55, F56) (13-)										
1.2 One	Petrol	75	B38 A12 A		04/14-10/17		DAN1464	14	180	
1.2 One First	Petrol	55	B38 A12 A		06/14-10/17		DAN1464	14	180	
1.5 Cooper	Petrol	100	B36 A15 A;B38 A15 A		09/13-		DAN1464	14	180	
1.5 Cooper D	Diesel	85	B37 C15 A		10/13-		DAN1464	14	180	
1.5 One D	Diesel	70	B37 C15 A		02/14-		DAN1464	14	180	
2.0 Cooper S	Petrol	120/141	B46 A20 A;B48 A20 A; B48 A20 F		09/13-		DAN1464	14	180	
2.0 Cooper S JCW	Petrol	155	B46 A20 A;B48 A20 A		09/13-		DAN1464	14	180	
2.0 Cooper SD	Diesel	120/125	B47 C20 A;B47 C20 B		09/13-		DAN1464	14	180	
2.0 JCW	Petrol	170	B46 A20 B;B48 A20 B		03/15-		DAN1464	14	180	
MINI (R50, R53) (01-06)										
1.4 One D	Diesel	55/65	1ND;W17 D14 (1ND)		06/03-07/06		DAN981	14	130	
MINI Clubman (F54) (14-)										
1.5 Cooper	Petrol	100	B36 A15 A;B38 A15 A		12/14-		DAN1464	14	180	
1.5 One	Petrol	75	B38 A15 A		02/15-		DAN1464	14	180	
1.5 One D	Diesel	85	B37 C15 A		02/15-		DAN1464	14	180	
2.0 Cooper D	Diesel	100/110	B47 C20 A;B47 C20 B		12/14-		DAN1464	14	180	
2.0 Cooper S	Petrol	120/141	B46 A20 A;B48 A20 A; B48 A20 F		11/14-		DAN1464	14	180	
2.0 Cooper S ALL4	Petrol	120/141	B48 A20 A		04/15-		DAN1464	14	180	
2.0 Cooper S JCW	Petrol	155	B46 A20 A;B48 A20 A; B48 A20 F		11/14-06/18		DAN1464	14	180	
2.0 Cooper S JCW ALL4	Petrol	155	B48 A20 A		11/14-		DAN1464	14	180	
2.0 Cooper SD	Diesel	120/140	B47 C20 A;B47 C20 B		02/15-		DAN1464	14	180	
2.0 Cooper SD ALL4	Diesel	120/140	B47 C20 A;B47 C20 B		04/15-		DAN1464	14	180	
2.0 JCW	Petrol	170	B48 A20 B		11/16-06/19		DAN1464	14	180	
MINI Convertible (F57) (14-)										
1.2 One	Petrol	75	B38 A12 A		06/15-10/17		DAN1464	14	180	
1.5 Cooper	Petrol	100	B36 A15 A;B38 A15 A		11/14-		DAN1464	14	180	
1.5 Cooper D	Diesel	85	B37 C15 A		12/14-		DAN1464	14	180	
2.0 Cooper S	Petrol	120/141	B46 A20 A;B48 A20 A		11/14-		DAN1464	14	180	
2.0 Cooper S JCW	Petrol	155	B46 A20 A;B48 A20 A		11/14-		DAN1464	14	180	
2.0 Cooper SD	Diesel	120/125	B47 C20 A;B47 C20 B		05/15-		DAN1464	14	180	
2.0 JCW	Petrol	170	B48 A20 B		05/15-		DAN1464	14	180	
MINI Countryman (F60) (16-)										
1.5 Cooper	Petrol	100	B36 A15 A;B38 A15 A; B38 A15 F		10/16-		DAN1464	14	180	
1.5 Cooper ALL4	Petrol	100	B38 A15 A;B38 A15 F		10/16-		DAN1464	14	180	
1.5 One	Petrol	75	B38 A15 A		07/17-		DAN1464	14	180	
1.5 One D	Diesel	85	B37 C15 A		07/17-		DAN1464	14	180	
2.0 Cooper D	Diesel	100/110	B47 C20 A;B47 C20 B		10/16-		DAN1464	14	180	
2.0 Cooper D ALL4	Diesel	100/110	B47 C20 A;B47 C20 B		10/16-		DAN1464	14	180	
2.0 Cooper S	Petrol	120/141	B46 A20 A;B48 A20 A		10/16-		DAN1464	14	180	
2.0 Cooper S ALL4	Petrol	120/141	B46 A20 A;B48 A20 A		10/16-		DAN1464	14	180	
2.0 Cooper SD	Diesel	120/140	B47 C20 A;B47 C20 B		10/16-		DAN1464	14	180	
2.0 Cooper SD ALL4	Diesel	120/140	B47 C20 A;B47 C20 B		10/16-		DAN1464	14	180	
2.0 JCW ALL4	Petrol	170	B48 A20 B		03/17-06/19		DAN1464	14	180	
NISSAN										
ALMERA II (00-06)										
1.5	Petrol	66/72	QG15DE		03/00-11/06		DAN1031	14	80	
1.8	Petrol	85	QG18DE		01/00-09/06		DAN1031	14	80	
2.2 dCi	Diesel	82/100	YD22DDT;YD22DDTi		09/03-09/06		DAN1030	14	100	
2.2 Di	Diesel	81	YD22DDT		03/00-04/03		DAN1030	14	100	
ALMERA TINO (00-06)										
1.8	Petrol	85	QG18DE		08/00-02/06		DAN1031	14	80	
2.2 dCi	Diesel	82/84/ 100	YD22DDTi		08/00-02/06		DAN1030	14	100	
AVENIR (97-05)										
1.8	Petrol	92	QG18DE		11/97-08/02		DAN1031	14	80	
PRIMERA (P11) (96-02)										
1.6 16V	Petrol	66/73/78	GA16DE;QG16DE		09/00-07/02		DAN1031	14	80	
1.8 16V	Petrol	84	QG18DE		08/99-07/02		DAN1031	14	80	























A











NISSAN <small>continued</small>									
PRIMERA (P12) (02-)									
1.6	Petrol	78/80	QG16DE		01/02-08/08		DAN1031	14	80
1.6 Visia	Petrol	80	QG16DE		01/02-04/06		DAN1031	14	80
1.8	Petrol	85	QG18DE		03/02-10/08		DAN1031	14	80
OPEL									
AGILA A (00-07)									
1.0	Petrol	44	Z 10 XEP		08/03-12/07	2 pin plug	DAN1055	14	70
1.2 16V Twinport	Petrol	59	Z 12 XEP		07/04-12/07		DAN1055	14	70
1.3 CDTI	Diesel	51	Z 13 DT		08/03-12/07		DAN1032	14	70
1.3 CDTI	Diesel	51	Z 13 DT		08/03-12/07		DAN1033	14	105
ASTRA F (91-01)									
1.4	Petrol	60	14 SE		09/92-09/98	+ PS	DAN1342	14	100
1.4	Petrol	60	14 SE		09/94-09/98	- PS	DAN1343	14	70
1.4 i	Petrol	44	C 14 NZ;X 14 NZ		09/91-01/99	+ PS	DAN1342	14	100
1.4 i	Petrol	44	C 14 NZ;X 14 NZ		09/94-01/99	- PS	DAN1343	14	70
1.4 i 16V	Petrol	66	X 14 XE		01/96-03/01		DAN1342	14	100
1.4 Si	Petrol	60	C 14 SE		03/92-03/01	+ PS	DAN1342	14	100
1.4 Si	Petrol	60	C 14 SE		09/94-03/01	- PS	DAN1343	14	70
1.6	Petrol	55	16 LZ2		09/95-09/98		DAN1342	14	100
1.6	Petrol	55	16 NZR		09/95-09/98	- PS	DAN1343	14	70
1.6	Petrol	55	16 NZR		09/95-09/98	+ PS	DAN1342	14	100
1.6 i	Petrol	52/55	C 16 NZ;X 16 SZ; X 16 SZR		09/91-03/01	+ PS	DAN1342	14	100
1.6 i	Petrol	52/55	C 16 NZ;X 16 SZ; X 16 SZR		09/94-03/01	- PS	DAN1343	14	70
1.6 i 16V	Petrol	74	X 16 XEL		08/94-09/98		DAN1342	14	100
1.6 Si	Petrol	74	C 16 SE		03/92-12/94	+ PS	DAN1342	14	100
1.6 Si	Petrol	74	C 16 SE		09/94-12/94	- PS	DAN1343	14	70
1.8 i	Petrol	66	C 18 NZ		09/92-09/98		DAN1342	14	100
1.8 i 16V	Petrol	85/92	C 18 SEL;C 18 XE; C 18 XEL;X 18 XE		06/93-03/01		DAN1342	14	100
2.0 GSI 16V	Petrol	110	C 20 XE		09/91-01/98		DAN1342	14	100
2.0 i	Petrol	85	C 20 NE		09/92-09/98		DAN1342	14	100
2.0 i 16V	Petrol	100/110	C 20 XE;X 20 XEV		03/93-09/98		DAN1342	14	100
ASTRA F CLASSIC (98-05)									
1.4 i	Petrol	44	X 14 NZ		01/98-01/05	- PS	DAN1343	14	70
1.6 i	Petrol	55	X 16 SZR		01/98-01/05	- PS	DAN1343	14	70
ASTRA G (98-09)									
1.4 16V	Petrol	66	X 14 XE;Z 14 XE		02/98-01/05		DAN1341	14	100
1.6	Petrol	55/62	X 16 SZR;Z 16 SE		02/98-04/05		DAN1341	14	100
1.6 16V	Petrol	74	C 16 SEL;X 16 XEL; Z 16 XE		02/98-10/05		DAN1341	14	100
1.6 CNG	Petrol/ Compressed Natural Gas (CNG)	71	Z 16 YNG		03/03-07/04		DAN1341	14	100
1.6 LPG	Petrol/ Liquefied Petroleum Gas (LPG)	74	X 16 XEL;Z 16 XE		03/98-01/05		DAN1341	14	100
1.8 16V	Petrol	85/92	X 18 XE1;Z 18 XE		02/98-10/05		DAN1341	14	100
2.0 16V	Petrol	100	X 20 XEV		02/98-01/05		DAN1341	14	100
2.0 16V OPC	Petrol	118	X 20 XER		11/99-09/02		DAN1341	14	100
2.0 16V Turbo	Petrol	141/147	Z 20 LET		09/00-10/05		DAN1341	14	100
2.0 OPC	Petrol	141/147	Z 20 LET		03/02-10/05		DAN1341	14	100
2.2 16V	Petrol	108	Z 22 SE		03/01-08/05		DAN1341	14	100
ASTRA G CLASSIC (09-)									
1.3 CDTI	Diesel	66	Z 13 DTH		01/09-		DAN1034	14	120
1.4	Petrol	66	Z 14 XEP		01/09-03/10		DAN1340	14	100
ASTRA H (04-14)									
1.2	Petrol	59	Z 12 XEP		08/05-10/10	2 pin plug	DAN1055	14	70
1.2	Petrol	59	Z 12 XEP		08/05-10/10	2 pin plug	DAN1340	14	100
1.3 CDTI	Diesel	66	Z 13 DTH		04/05-10/10		DAN1032	14	70
1.3 CDTI	Diesel	66	Z 13 DTH		04/05-10/10		DAN1033	14	105
1.3 CDTI	Diesel	66	Z 13 DTH		04/05-10/10		DAN1034	14	120
1.4	Petrol	55	Z 14 XEL		04/04-10/10	2 pin plug	DAN1033	14	105
1.4	Petrol	55/66	Z 14 XEL;Z 14 XEP		03/04-10/10	2 pin plug	DAN1055	14	70



		 kW																	
OPEL continued																			
ASTRA H (04-14) continued																			
1.4	Petrol	55/66	Z 14 XEL;Z 14 XEP		03/04-10/10	2 pin plug	DAN1340	14	100										
1.4	Petrol	66	Z 14 XEP		02/07-03/10		DAN1340	14	100										
1.4 EcoTec	Petrol	66	Z 14 XEP		12/04-03/10		DAN1340	14	100										
1.4 LPG	Petrol/ Liquified Petroleum Gas (LPG)	66	Z 14 XEP		08/09-10/10	2 pin plug	DAN1055	14	70										
1.4 LPG	Petrol/ Liquified Petroleum Gas (LPG)	66	Z 14 XEP		08/09-10/10	2 pin plug	DAN1340	14	100										
1.8	Petrol	92	Z 18 XE		01/04-10/10		DAN1341	14	100										
1.9 CDTI	Diesel	74	Z 19 DTL		09/05-10/10	Ch No: >72207929; 75189052;78104400;7G	DAN510	14	105										
1.9 CDTI	Diesel	74	Z 19 DTL		09/05-10/10	Ch No: >72207929; 75189052;78104400;7G	DAN506	14	120										
1.9 CDTI	Diesel	74	Z 19 DTL		09/05-10/10	Ch No: >72207929; 75189052;78104400;7G	DAN509	14	130										
1.9 CDTI	Diesel	110	Z 19 DTH		09/04-10/10	Ch No: >72212298; 75189052;78104400;7G	DAN510	14	105										
1.9 CDTI	Diesel	110	Z 19 DTH		09/04-10/10	Ch No: >72212298; 75189052;78104400;7G	DAN506	14	120										
1.9 CDTI	Diesel	110	Z 19 DTH		09/04-10/10	Ch No: >72212298; 75189052;78104400;7G	DAN509	14	130										
1.9 CDTI 16V	Diesel	88	Z 19 DTJ		04/04-10/10	Ch No: >72212298; 75189052;78104400;7G	DAN510	14	105										
1.9 CDTI 16V	Diesel	88	Z 19 DTJ		04/04-10/10	Ch No: >72212298; 75189052;78104400;7G	DAN506	14	120										
1.9 CDTI 16V	Diesel	88	Z 19 DTJ		04/04-10/10	Ch No: >72212298; 75189052;78104400;7G	DAN509	14	130										
1.9 CDTI 8V	Diesel	88	Z 19 DT		06/04-10/10	+ MY2007;- POC: WFJ	DAN506	14	120										
1.9 CDTI 8V	Diesel	88	Z 19 DT		06/04-10/10	Ch No: >72172468; 75189052;78104400;7G	DAN510	14	105										
1.9 CDTI 8V	Diesel	88	Z 19 DT		06/04-10/10	Ch No: >72172468; 75189052;78104400;7G	DAN509	14	130										
1.9 CDTI 8V	Diesel	88	Z 19 DT		06/04-10/10	MY: >2007	DAN506	14	120										
ASTRA J (09-)																			
1.6 CDTI	Diesel	81/100	B 16 DTH;B 16 DTL		11/13-	VA;-/+ SS	DAN1331	14	140										
1.6 SIDI	Petrol	125/147	A 16 SHT;A 16 XHT; B 16 SHL;B 16 SHT		12/12-	VA;-/+ SS	DAN1331	14	140										
ASTRA K (15-)																			
1.6 CDTI	Diesel	70/81/ 100/118	B 16 DTE;B 16 DTH; B 16 DTR;B 16 DTU; D 16 DTH;D 16 DTI		06/15-	-/+ SS	DAN1331	14	140										
1.6 Turbo	Petrol	147	B 16 SHT		11/15-	-/+ SS	DAN1331	14	140										
CALIBRA (90-97)																			
2.0 i	Petrol	85	C 20 NE		08/89-12/96	Ch No: P1000001; P9000001>	DAN1342	14	100										
2.0 i 16V	Petrol	100	X 20 XEV		02/94-07/97		DAN1342	14	100										
2.0 i 16V	Petrol	110	C 20 XE		06/90-02/94	Ch No: P1000001; P9000001>	DAN1342	14	100										
2.0 i 16V 4x4	Petrol	100	X 20 XEV		02/94-07/97		DAN1342	14	100										
2.0 i 16V 4x4	Petrol	110	C 20 XE		06/90-02/94	Ch No: P1000001; P9000001>	DAN1342	14	100										
2.0 i 4x4	Petrol	85	C 20 NE		06/90-07/97	Ch No: P1000001; P9000001>	DAN1342	14	100										
2.0 i Turbo 4x4	Petrol	150	C 20 LET		08/91-07/97	Ch No: P1000001; P9000001>	DAN1342	14	100										
CASCADA (13-19)																			
1.6	Petrol	147	A 16 SHT;B 16 SHT		11/13-04/18	VA;-/+ SS	DAN1331	14	140										
1.6 SIDI	Petrol	125	A 16 XHT;B 16 SHL; D 16 SHL		04/13-04/19	VA;-/+ SS	DAN1331	14	140										
COMBO B (94-01)																			
1.4	Petrol	44/60	C 14 NZ;C 14 SE; X 14 SZ		07/94-10/01	-/+ AC;+ PS	DAN1342	14	100										
1.4	Petrol	44/60	C 14 NZ;C 14 SE; X 14 SZ		09/94-10/01	- PS	DAN1343	14	70										
1.4 16V	Petrol	66	X 14 XE		08/99-10/01		DAN1342	14	100										
COMBO C (01-)																			
1.3 CDTI 16V	Diesel	51/55	Y 13 DT;Z 13 DT; Z 13 DTJ		06/04-		DAN1032	14	70										
1.3 CDTI 16V	Diesel	51/55	Y 13 DT;Z 13 DT; Z 13 DTJ		06/04-		DAN1033	14	105										











																		A	
OPEL continued																			
COMBO C (01-) continued																			
1.3 CDTI 16V	Diesel	51/55	Y 13 DT;Z 13 DT; Z 13 DTJ		06/04-		DAN1034	14	120										
1.4	Petrol	66	Z 14 XEP		10/04-12/11	2 pin plug	DAN1055	14	70										
1.4	Petrol	66	Z 14 XEP		10/04-12/11	Ch No: 73-;74->; 2 pin plug	DAN1340	14	100										
1.4 16V	Petrol	66	Z 14 XEP		08/05-	2 pin plug	DAN1055	14	70										
1.4 16V	Petrol	66	Z 14 XEP		08/05-	Ch No: 73-;74->; 2 pin plug	DAN1340	14	100										
1.6	Petrol	64	Z 16 SE		10/01-		DAN1341	14	100										
COMBO E (18-)																			
1.2	Petrol	33	C 12 NZ;X 12 SZ		09/94-10/01	- PS	DAN1343	14	70										
1.2	Petrol	33	C 12 NZ;X 12 SZ		09/94-10/01	-/+ AC;+ PS	DAN1342	14	100										
CORSA B (93-02)																			
1.2 i	Petrol	33	12 NZ;C 12 NZ; X 12 SZ		09/94-09/00	- PS	DAN1343	14	70										
1.2 i	Petrol	33	12 NZ;C 12 NZ; X 12 SZ		09/94-09/00	-/+ AC;+ PS	DAN1342	14	100										
1.4 i	Petrol	44	C 14 NZ;X 14 SZ		03/93-09/00	-/+ AC;+ PS	DAN1342	14	100										
1.4 i	Petrol	44	C 14 NZ;X 14 SZ		09/94-09/00	- PS	DAN1343	14	70										
1.4 i 16V	Petrol	63/66	C 14 SEL;X 14 XE		09/94-12/02		DAN1342	14	100										
1.4 Si	Petrol	60	C 14 SE		03/93-09/00	-/+ AC;+ PS	DAN1342	14	100										
1.4 Si	Petrol	60	C 14 SE		09/94-09/00	- PS	DAN1343	14	70										
1.6 GSI 16V	Petrol	80	C 16 XE		03/93-09/00		DAN1342	14	100										
1.6 i 16V	Petrol	74/78	C 16 SEL;X 16 XE		09/94-09/00		DAN1342	14	100										
CORSA C (00-09)																			
1.0	Petrol	44	Z 10 XE		09/00-06/03	Ch No: 23000001; 24000001;26000001>; 2 pin plug	DAN1055	14	70										
1.0	Petrol	44	Z 10 XEP		06/03-12/09	2 pin plug	DAN1055	14	70										
1.2	Petrol	55	Z 12 XE		09/00-12/09	Ch No: 23000001; 24000001;26000001>; 2 pin plug	DAN1055	14	70										
1.2	Petrol	59	Z 12 XEP		07/05-12/09	2 pin plug	DAN1055	14	70										
1.2 16V	Petrol	55	Z 12 XE		09/00-12/09	Ch No: 23000001; 24000001;26000001>; 2 pin plug	DAN1055	14	70										
1.2 Twinport	Petrol	59	Z 12 XEP		07/04-12/09	2 pin plug	DAN1055	14	70										
1.3 CDTI	Diesel	51	Y 13 DT;Z 13 DT		06/03-12/09		DAN1032	14	70										
1.3 CDTI	Diesel	51	Y 13 DT;Z 13 DT		06/03-12/09		DAN1033	14	105										
1.3 CDTI	Diesel	51	Y 13 DT;Z 13 DT		06/03-12/09		DAN1034	14	120										
1.3 CDTI 16V	Diesel	51	Z 13 DT		07/05-12/09		DAN1032	14	70										
1.3 CDTI 16V	Diesel	51	Z 13 DT		07/05-12/09		DAN1033	14	105										
1.3 CDTI 16V	Diesel	51	Z 13 DT		07/05-12/09		DAN1034	14	120										
1.4	Petrol	66	Z 14 XE		09/00-12/09		DAN1341	14	100										
1.4	Petrol	66	Z 14 XEP		08/03-12/09	2 pin plug	DAN1055	14	70										
1.4	Petrol	66	Z 14 XEP		08/03-12/09	Ch No: 73-;74->; 2 pin plug	DAN1340	14	100										
1.4 Twinport	Petrol	66	Z 14 XEP		06/03-12/09	2 pin plug	DAN1055	14	70										
1.4 Twinport	Petrol	66	Z 14 XEP		06/03-12/09	Ch No: 73-;74->; 2 pin plug	DAN1340	14	100										
1.8	Petrol	92	Z 18 XE		09/00-12/09		DAN1341	14	100										
CORSA D (06-14)																			
1.0	Petrol	44/48	A 10 XEP;Z 10 XEP		07/06-08/14		DAN1340	14	100										
1.0	Petrol	44/48	A 10 XEP;Z 10 XEP		07/06-08/14	Ch No: >A4999999; A6999999	DAN1055	14	70										
1.2	Petrol	51/59/63	A 12 XEL;A 12 XER; Z 12 XEP		07/06-08/14		DAN1340	14	100										
1.2	Petrol	51/59/63	A 12 XEL;A 12 XER; Z 12 XEP		07/06-08/14	Ch No: >A4999999; A6999999	DAN1055	14	70										
1.2 LPG	Petrol/ Liquified Petroleum Gas (LPG)	59	Z 12 XEP		08/06-08/14	Ch No: >A4999999; A6999999	DAN1055	14	70										
1.2 LPG	Petrol/ Liquified Petroleum Gas (LPG)	59/61/63	A 12 XER;Z 12 XEP		08/06-08/14		DAN1340	14	100										











									
OPEL continued									
CORSA D (06-14) continued									
1.3 CDTI	Diesel	55/66/70	A 13 DTC;A 13 DTE; A 13 DTR;Z 13 DTE; Z 13 DTH;Z 13 DTJ		07/06-08/14		DAN583	14	70
1.3 CDTI	Diesel	55/66/70	A 13 DTC;A 13 DTE; A 13 DTR;Z 13 DTE; Z 13 DTH;Z 13 DTJ		07/06-08/14		DAN584	14	105
1.3 CDTI	Diesel	55/66/70	A 13 DTC;A 13 DTE; A 13 DTR;Z 13 DTE; Z 13 DTH;Z 13 DTJ		07/06-08/14		DAN585	14	120
1.4	Petrol	66	Z 14 XEP		07/06-08/14		DAN1340	14	100
1.4	Petrol	66	Z 14 XEP		07/06-08/14	Ch No: >A4999999; A6999999	DAN1055	14	70
1.4 LPG	Petrol/ Liquified Petrol eum Gas (LPG)	64/66	Z 14 XEP		08/06-12/11		DAN1340	14	100
1.4 LPG	Petrol/ Liquified Petrol eum Gas (LPG)	66	Z 14 XEP		08/06-12/11	Ch No: >A4999999; A6999999	DAN1055	14	70
CORSA E (14-)									
1.2	Petrol	51	B 12 XEL		09/14-	-/+ SS	DAN1322	14	100
1.2	Petrol	51	B 12 XEL		09/14-	-/+ SS	DAN1334	14	140
1.4	Petrol	55/66	B 14 XEJ;B 14 XEL; D 14 XEL		09/14-	-/+ SS	DAN1322	14	100
1.4	Petrol	55/66	B 14 XEJ;B 14 XEL; D 14 XEL		09/14-	-/+ SS	DAN1334	14	140
1.4 LPG	Petrol/ Liquified Petrol eum Gas (LPG)	64/66	B 14 XEL		03/15-	-/+ SS	DAN1322	14	100
1.4 LPG	Petrol/ Liquified Petrol eum Gas (LPG)	64/66	B 14 XEL		03/15-	-/+ SS	DAN1334	14	140
1.4 Turbo	Petrol	74/110	B 14 NEH;B 14 NEJ; D 14 NEH;D 14 NEJ		09/14-	-/+ SS	DAN1322	14	100
1.4 Turbo	Petrol	74/110	B 14 NEH;B 14 NEJ; D 14 NEH;D 14 NEJ		09/14-	-/+ SS	DAN1334	14	140
FRONTERA A (92-98)									
2.0 i	Petrol	85	X 20 SE		04/95-10/98	- AC	DAN1342	14	100
2.2 i	Petrol	100	X 22 XE		03/95-10/98	- AC	DAN1342	14	100
FRONTERA B (98-04)									
2.2 i	Petrol	100	X 22 SE;Y 22 SE		10/98-07/04		DAN1342	14	100
INSIGNIA (A) (08-17)									
1.6 CDTI	Diesel	88/100	B 16 DTH;B 16 DTJ		07/15-03/17	VA;-/+ SS	DAN1331	14	140
1.6 SIDI	Petrol	125	A 16 XHT;B 16 SHL		03/13-03/17	VA;-/+ SS	DAN1331	14	140
INSIGNIA (B) (17-)									
1.6 CDTI	Diesel	81/100	B 16 DTE;B 16 DTH; D 16 DTE;D 16 DTH; D 16 DTN		03/17-	-/+ SS;- HWS	DAN1331	14	140
MERIVA A (03-10)									
1.3 CDTI	Diesel	51/55	Y 13 DT;Z 13 DT; Z 13 DTJ		09/03-05/10		DAN1032	14	70
1.3 CDTI	Diesel	51/55	Y 13 DT;Z 13 DT; Z 13 DTJ		09/03-05/10		DAN1033	14	105
1.3 CDTI	Diesel	51/55	Y 13 DT;Z 13 DT; Z 13 DTJ		09/03-05/10		DAN1034	14	120
1.4 16V Twinport	Petrol	66	Z 14 XEP		07/04-05/10	Ch No: 74000001>; 2 pin plug	DAN1055	14	70
1.4 16V Twinport	Petrol	66	Z 14 XEP		07/04-05/10	Ch No: 74000001>; 2 pin plug	DAN1340	14	100
1.4 16V Twinport LPG	Petrol/ Liquified Petrol eum Gas (LPG)	66	Z 14 XEP		07/04-05/10	Ch No: 74000001>; 2 pin plug	DAN1055	14	70











									
OPEL continued									
MERIVA A (03-10) continued									
1.4 16V Twinport LPG	Petrol/ Liquified Petroleum Gas (LPG)	66	Z 14 XEP		07/04-05/10	Ch No: 74000001>; 2 pin plug	DAN1340	14	100
1.6	Petrol	64	Z 16 SE		05/03-05/10		DAN1341	14	100
1.6 16V	Petrol	74	Z 16 XE		05/03-01/06		DAN1341	14	100
1.8	Petrol	92	Z 18 XE		05/03-05/10		DAN1341	14	100
MERIVA B (10-17)									
1.3 CDTI	Diesel	55/70	A 13 DTC;A 13 DTE		06/10-11/14		DAN583	14	70
1.3 CDTI	Diesel	55/70	A 13 DTC;A 13 DTE		06/10-11/14		DAN584	14	105
1.3 CDTI	Diesel	55/70	A 13 DTC;A 13 DTE		06/10-11/14		DAN585	14	120
1.6 CDTI	Diesel	70/81/ 100	B 16 DTC;B 16 DTE; B 16 DTH;B 16 DTL; B 16 DTN		08/13-03/17	VA;-/+ SS	DAN1331	14	140
MONTEREY B (98-99)									
3.5 V6 24V	Petrol	158	6 VE1		07/98-08/99		DAN1488	14	90
OMEGA B (94-03)									
2.0	Petrol	85	20 SE;X 20 SE		03/94-12/00		DAN1342	14	100
2.0 16V	Petrol	100	X 20 XEV		03/94-09/99		DAN1342	14	100
2.2 16V	Petrol	106	Y 22 XE;Z 22 XE		09/99-07/03		DAN1342	14	100
SIGNUM (03-08)									
1.8	Petrol	90	Z 18 XE		05/03-07/05		DAN1341	14	100
1.9 CDTI	Diesel	74/88/ 110	Z 19 DT;Z 19 DTH; Z 19 DTL		04/04-02/08	Ch No: >71111927	DAN510	14	105
1.9 CDTI	Diesel	74/88/ 110	Z 19 DT;Z 19 DTH; Z 19 DTL		04/04-02/08	Ch No: >71111927	DAN506	14	120
1.9 CDTI	Diesel	74/88/ 110	Z 19 DT;Z 19 DTH; Z 19 DTL		04/04-02/08	Ch No: >71111927	DAN509	14	130
SPEEDSTER (00-06)									
2.0 Turbo	Petrol	147	Z 20 LET		08/02-08/06		DAN1341	14	100
TIGRA (94-00)									
1.4 16V	Petrol	63/66	X 14 XE		07/94-12/00		DAN1342	14	100
1.6 16V	Petrol	74/78	C 16 SEL;X 16 XE		07/94-08/98		DAN1342	14	100
TIGRA TwinTop (04-10)									
1.3 CDTI	Diesel	51	Z 13 DT		06/04-12/10		DAN1032	14	70
1.3 CDTI	Diesel	51	Z 13 DT		06/04-12/10		DAN1033	14	105
1.3 CDTI	Diesel	51	Z 13 DT		06/04-12/10		DAN1034	14	120
1.4	Petrol	66	Z 14 XEP		06/04-12/10	2 pin plug	DAN1055	14	70
1.4	Petrol	66	Z 14 XEP		06/04-12/10	2 pin plug	DAN1340	14	100
1.8	Petrol	92	Z 18 XE		06/04-12/10		DAN1341	14	100
VECTRA A (88-95)									
1.6	Petrol	51/60	16 SV;C 16 LZ2		08/92-07/93	+ PS	DAN1342	14	100
1.6 i	Petrol	52/55	16 LZ2;C 16 LZ2; C 16 NZ;C 16 NZ2; E 16 NZ;X 16 SZ		09/88-11/95	+ PS	DAN1342	14	100
1.6 i	Petrol	52/55	C 16 NZ;E 16 NZ; X 16 SZ		09/94-11/95	- PS	DAN1343	14	70
1.6 i Cat	Petrol	55	C 16 NZ		09/94-11/95	- PS	DAN1343	14	70
1.6 i Cat	Petrol	55	C 16 NZ;C 16 NZ2		09/88-11/95	+ PS	DAN1342	14	100
1.6 S	Petrol	60	16 SV		09/92-05/93	+ PS	DAN1342	14	100
1.8 i Cat	Petrol	66	C 18 NZ		03/90-11/95	+ PS	DAN1342	14	100
2.0	Petrol	74	C 20 NEF		04/88-09/89	+ PS	DAN1342	14	100
2.0 i	Petrol	85/95	20 NE;20 SEH		09/88-09/92	+ PS	DAN1342	14	100
2.0 i 16V	Petrol	100/110	20 XEJ;X 20 XEV		02/89-08/95	+ PS	DAN1342	14	100
2.0 i 16V 4x4	Petrol	100	X 20 XEV		06/94-11/95	+ PS	DAN1342	14	100
2.0 i 16V Cat	Petrol	110	C 20 XE		02/90-11/95	+ PS	DAN1342	14	100
2.0 i 4x4	Petrol	85/95	20 NE;20 SEH		01/89-07/92	+ PS	DAN1342	14	100
2.0 i Cat	Petrol	85	C 20 NE		09/88-11/95	+ PS	DAN1342	14	100
2.0 i Cat 4x4	Petrol	85	C 20 NE		01/89-11/95	+ PS	DAN1342	14	100
2.0 i GT	Petrol	95	20 SEH		09/88-11/95	+ PS	DAN1342	14	100
2.0 i Turbo 4x4	Petrol	150	C 20 LET		06/94-11/95	+ PS	DAN1342	14	100
2000/GT 16V	Petrol	110	20 XEJ		01/89-06/94	+ PS	DAN1342	14	100
2000/GT 16V 4x4	Petrol	110	20 XEJ		01/89-10/90	+ PS	DAN1342	14	100
2000/GT 16V Cat	Petrol	110	C 20 XE		02/90-11/95	+ PS	DAN1342	14	100
2000/GT 16V Cat 4x4	Petrol	110	C 20 XE		02/90-11/95	+ PS	DAN1342	14	100
VECTRA B (95-03)									
1.6 i	Petrol	55	16 LZ2;X 16 SZR		10/95-07/03		DAN1342	14	100
1.6 i 16V	Petrol	74	X 16 XEL;Y 16 XE; Z 16 XE		10/95-07/02		DAN1342	14	100











																					
OPEL continued																					
VECTRA B (95-03) continued																					
1.8 i 16V	Petrol	85/92	X 18 XE;X 18 XE1; Z 18 XE;Z 18 XEL			10/95-07/03				DAN1342	14	100									
2.0 i	Petrol	82	20 NEJ			10/95-04/02				DAN1342	14	100									
2.0 i 16V	Petrol	100	C 20 SEL;X 20 XEV			09/95-06/00				DAN1342	14	100									
VECTRA C (02-08)																					
1.6	Petrol	74	Z 16 XE			08/05-08/08				DAN1341	14	100									
1.6 16V	Petrol	74	Z 16 XE			06/04-10/05				DAN1341	14	100									
1.8	Petrol	81/90	Z 18 XE;Z 18 XEL			04/02-07/08				DAN1341	14	100									
1.8 16V	Petrol	81/90	Z 18 XE;Z 18 XEL			04/02-09/08				DAN1341	14	100									
1.9 CDTI	Diesel	74	Z 19 DTL			06/05-08/08			Ch No: >71111927	DAN510	14	105									
1.9 CDTI	Diesel	74	Z 19 DTL			06/05-08/08			Ch No: >71111927	DAN506	14	120									
1.9 CDTI	Diesel	74	Z 19 DTL			06/05-08/08			Ch No: >71111927	DAN509	14	130									
1.9 CDTI	Diesel	88/110	Z 19 DT;Z 19 DTH			04/04-01/09			Ch No: >71111927; 48999999	DAN510	14	105									
1.9 CDTI	Diesel	88/110	Z 19 DT;Z 19 DTH			04/04-01/09			Ch No: >71111927; 48999999	DAN506	14	120									
1.9 CDTI	Diesel	88/110	Z 19 DT;Z 19 DTH			04/04-01/09			Ch No: >71111927; 48999999	DAN509	14	130									
ZAFIRA A (99-05)																					
1.6 16V	Petrol	74	X 16 XEL;Z 16 XE			04/99-06/05				DAN1341	14	100									
1.6 CNG	Petrol/ Compre ssed Natur al Gas(CNG)	71	Z 16 YNG			09/01-06/05				DAN1341	14	100									
1.8 16V	Petrol	85/92	X 18 XE1;Z 18 XE			04/99-06/05				DAN1341	14	100									
2.0 OPC	Petrol	141/147	Z 20 LET			09/01-06/05				DAN1341	14	100									
ZAFIRA B (05-14)																					
1.6 CNG	Petrol/ Compre ssed Natur al Gas(CNG)	69	Z 16 YNG			07/05-04/15				DAN1341	14	100									
1.9 CDTI	Diesel	74/88/ 110	Z 19 DTH;Z 19 DTL			07/05-04/15			+ MY2007;- POC: WFJ	DAN510	14	105									
1.9 CDTI	Diesel	74/88/ 110	Z 19 DTH;Z 19 DTL			07/05-04/15			+ MY2007;- POC: WFJ	DAN506	14	120									
1.9 CDTI	Diesel	74/88/ 110	Z 19 DTH;Z 19 DTL			07/05-04/15			+ MY2007;- POC: WFJ	DAN509	14	130									
1.9 CDTI	Diesel	74/88/ 110	Z 19 DTH;Z 19 DTL			07/05-04/15			MY: >2007	DAN510	14	105									
1.9 CDTI	Diesel	74/88/ 110	Z 19 DTH;Z 19 DTL			07/05-04/15			MY: >2007	DAN506	14	120									
1.9 CDTI	Diesel	74/88/ 110	Z 19 DTH;Z 19 DTL			07/05-04/15			MY: >2007	DAN509	14	130									
ZAFIRA Tourer C (11-)																					
1.6	Petrol	100	D 16 SHJ			09/18-				DAN1331	14	140									
1.6	Petrol	125	A 16 XHT;B 16 SHL; D 16 SHL			12/12-			VA;-/+ SS	DAN1331	14	140									
1.6 CDTI	Diesel	88/100	B 16 DTH;B 16 DTJ; D 16 DTH;D 16 DTJ			02/13-			VA;-/+ SS	DAN1331	14	140									
1.6 SIDI	Petrol	147	A 16 SHT;B 16 SHT			07/13-			VA;-/+ SS	DAN1331	14	140									
PEUGEOT																					
106 II (96-04)																					
1.0 i	Petrol	33/37	CDY (TU9M); CDZ (TU9M)			04/96-12/04			+ LS	DAN1063	14	80									
1.1 i	Petrol	40/44	HDY (TU1M+); HDZ (TU1M+); HFX (TU1JP)			05/96-12/04			+ LS	DAN1063	14	80									
1.4 i	Petrol	55	KFW (TU3JP); KFX (TU3JP)			05/96-07/04			+ LS	DAN1063	14	80									
1.6 8V	Petrol	65	NFZ (TU5JP)			05/96-10/99			+ LS	DAN1063	14	80									
1.6 i	Petrol	74	NFW (TU5J2); NFY (TU5J2)			05/96-01/01			+ LS	DAN1063	14	80									
1.6 S16	Petrol	87	NFX (TU5J4)			05/96-07/04			+ LS	DAN1063	14	80									
107 (05-14)																					
1.0	Petrol	50	CFA (384F); CFB (1KR)			06/05-05/14				DAN1035	14	70									
1.0	Petrol	50	CFA (384F); CFB (1KR)			06/05-05/14			+ Co;+ Ho	DAN1036	14	80									
206 (98-)																					
1.1	Petrol	40/44	HFY (TU1JP); HFZ (TU1JP)			08/98-05/13				DAN1336	14	90									

									
PEUGEOT continued									
206 (98-) continued									
1.1 i	Petrol	44	HFX (TU1JP); HFZ (TU1JP)		09/98-02/07	+ LS	DAN1336	14	90
1.4 16V	Petrol	65	KFU (ET3J4)		10/03-		DAN1336	14	90
1.4 i	Petrol	55	KFV (TU3A); KFW (TU3A); KFX (TU3JP); KFX (TU3JP)		09/98-	+ LS	DAN1336	14	90
1.6 16V	Petrol	80	NFU (TU5JP4)		07/00-	+ LS	DAN1336	14	90
1.6 8V	Petrol	65	NFZ (TU5JP)		09/98-12/00	+ LS	DAN1336	14	90
2.0 16V	Petrol	100	RFN (EW10J4)		06/99-12/07		DAN1336	14	90
2.0 RC	Petrol	130	RFK (EW10J4S)		07/03-12/07		DAN1336	14	90
2.0 S16	Petrol	100	RFR (EW10J4)		04/99-10/00		DAN1336	14	90
206 CC (00-08)									
1.6 16V	Petrol	80	NFU (TU5JP4)		09/00-12/07	+ LS	DAN1336	14	90
2.0 16V	Petrol	100	RFN (EW10J4)		09/00-12/07		DAN1336	14	90
206+ (09-13)									
1.1	Petrol	44	HFX (TU1A)		01/09-06/13		DAN1336	14	90
1.1 LPG	Petrol/ Liquified Petroleum Gas (LPG)	44	HFX (TU1A); HFX (TU1JP)		04/09-05/13		DAN1336	14	90
1.4 i	Petrol	55	KFT (TU3AE5); KFW (TU3A)		01/09-08/13		DAN1336	14	90
207 (06-15)									
1.4 16V	Petrol	65	KFU (ET3J4)		02/06-10/13	-/+ AC	DAN515	14	90
1.6 16V	Petrol	80	NFU (TU5JP4)		02/06-10/13		DAN515	14	90
208 I (12-)									
1.0	Petrol	50	EB0		03/12-		DAN1071	14	90
1.2	Petrol	60	EB2;EB2F		03/12-		DAN1071	14	90
1.2 THP 110	Petrol	81	EB2DT		01/13-		DAN1071	14	90
1.2 VTI / PureTech 68	Petrol	50	HMM (EB2FAD); HMP (EB2FB)		08/16-		DAN1071	14	90
1.6 GTi	Petrol	153	5GR (EP6FDTX)		10/14-		DAN1071	14	90
301 (12-)									
1.2 VTI 72	Petrol	53	EB2 M		11/12-		DAN1071	14	90
1.2 VTI 72	Petrol	53	EB2 M		11/12-		DAN1325	14	150
1.2 VTI 82	Petrol	60	HMZ (EB2F)		12/14-		DAN1071	14	90
1.2 VTI 82	Petrol	60	HMZ (EB2F)		12/14-		DAN1325	14	150
1.6 VTI 115	Petrol	85	NFP (EC5)		11/12-10/17		DAN515	14	90
306 (93-02)									
1.4	Petrol	55	KFW (TU3JP); KFX (TU3JP)		04/93-04/02	+ AC	DAN1063	14	80
1.4	Petrol	55	KFW (TU3JP); KFX (TU3JP)		01/01-04/02	- AC;+ PS	DAN1063	14	80
1.4 SL	Petrol	55	KFW (TU3JP); KFX (TU3JP)		06/94-05/01	+ AC	DAN1063	14	80
1.4 SL	Petrol	55	KFW (TU3JP); KFX (TU3JP)		01/01-05/01	- AC;+ PS	DAN1063	14	80
1.6	Petrol	72	NFT (TU5JP)		10/00-04/02	+ AC	DAN1063	14	80
1.6	Petrol	72	NFT (TU5JP)		01/01-04/02	- AC;+ PS	DAN1063	14	80
1.6 8V	Petrol	65	NFZ (TU5JP)		10/00-05/01	+ AC	DAN1063	14	80
1.6 8V	Petrol	65	NFZ (TU5JP)		01/01-05/01	- AC;+ PS	DAN1063	14	80
307 (00-12)									
1.4	Petrol	55	KFW (TU3JP)		08/00-09/03		DAN515	14	90
1.4 16V	Petrol	65	KFU (ET3J4)		11/03-07/07		DAN515	14	90
1.6 16V	Petrol	80	NFU (TU5JP4)		08/00-04/09		DAN515	14	90
1.6 BioFlex	Flexfuel	80	NFU (TU5JP4)		09/07-04/08		DAN515	14	90
2.0	Petrol	100	RFN (EW10J4)		03/02-06/05		DAN1336	14	90
2.0 16V	Petrol	100	RFN (EW10J4)		08/00-06/05		DAN1336	14	90
308 II (13-)									
1.2 THP 110	Petrol	81	EB2DT		11/13-		DAN1325	14	150
1.2 THP 130	Petrol	96	EB2DTS		11/13-		DAN1325	14	150
1.2 VTI 82	Petrol	60	EB2;EB2F		09/13-		DAN1325	14	150
406 (95-04)									
1.8 16V	Petrol	85	6FZ (EW7J4)		12/01-10/04		DAN1336	14	90
2.0 16V	Petrol	100	RFN (EW10J4)		12/01-10/04		DAN1336	14	90
2.0 16V HPI	Petrol	103	RLZ (EW10D)		12/01-10/04		DAN1336	14	90
2.2	Petrol	116	3FZ (EW12J4)		12/01-10/04		DAN1336	14	90
406 Coupe (97-04)									
2.0 16V	Petrol	100	RFN (EW10J4); RFV (XU10J4R)		12/01-12/04		DAN1336	14	90

									
PEUGEOT continued									
406 Coupe (97-04) continued									
2.2	Petrol	116	3FZ (EW12J4)		03/02-12/04		DAN1336	14	90
407 (04-11)									
1.8	Petrol	85	6FZ (EW7J4)		03/04-07/05		DAN1336	14	90
2.2	Petrol	116	3FZ (EW12J4)		03/04-12/04		DAN1336	14	90
607 (00-11)									
2.0	Petrol	100	RFN (EW10J4)		07/01-08/05		DAN1336	14	90
2.2 16V	Petrol	116	3FZ (EW12J4)		07/01-08/05		DAN1336	14	90
807 (02-)									
2.0	Petrol	100	RFN (EW10J4)		06/02-		DAN1336	14	90
2.2	Petrol	116	3FZ (EW12J4)		06/02-		DAN1336	14	90
1007 (05-)									
1.4	Petrol	54	KFV (TU3A); KFV (TU3JP)		04/05-		DAN515	14	90
1.4 16V	Petrol	65	KFU (ET3J4)		10/05-		DAN515	14	90
1.6 16V	Petrol	80	NFU (TU5JP4)		04/05-		DAN515	14	90
2008 I (13-)									
1.2 THP / PureTech 110	Petrol	81	EB2DT		01/15-		DAN1071	14	90
1.2 VTi 82	Petrol	60	EB2;EB2F		03/13-12/18		DAN1071	14	90
3008 (09-16)									
1.2 Turbo	Petrol	96	EB2DTS		01/15-08/16		DAN1325	14	150
3008 SUV (16-)									
1.2 THP / PureTech 130	Petrol	96	HNS (EB2ADTS); HNY (EB2DTS)		05/16-		DAN1325	14	150
5008 I (09-17)									
1.2 Turbo	Petrol	96	EB2DTS		01/15-03/17		DAN1325	14	150
5008 II (16-)									
1.2 Turbo	Petrol	96	HNS (EB2ADTS); HNY (EB2DTS)		12/16-		DAN1325	14	150
BIPPER (08-)									
1.3 HDi 75	Diesel	55	FHZ (F13DTE5)		10/10-	- AC	DAN1001	14	105
1.3 HDi 75	Diesel	55	FHZ (F13DTE5)		10/10-	+ AC	DAN997	14	120
1.3 HDi 75	Diesel	55	FHZ (F13DTE5)		10/10-	+ AC;ECO KIT	DAN1086	14	120
1.3 HDi 80	Diesel	59	FHY (F13DTE6)		12/15-	+ SS	DAN997	14	120
1.4	Petrol	54	KFV (TU3A)		02/08-		DAN1336	14	90
EXPERT (96-06)									
1.9 D	Diesel	51	WJY (DW8B)		06/98-09/01	+ LS	DAN1336	14	90
1.9 D 70	Diesel	51	WJY (DW8B)		09/01-12/06	+ LS	DAN1336	14	90
2.0	Petrol	100	RFN (EW10J4)		07/00-12/06	+ LS	DAN1336	14	90
PARTNER / RANCH (96-15)									
1.1	Petrol	44	HDZ (TU1M); HFX (TU1JP)		06/96-10/02	+ LS	DAN1063	14	80
1.4	Petrol	55	KFV (TU3A); KFW (TU3A); KFW (TU3JP); KFX (TU3JP);TU32		06/96-12/15		DAN1336	14	90
1.4	Petrol	55	KFW (TU3A); KFW (TU3JP); KFX (TU3JP);TU32		06/96-10/02	+ LS	DAN1063	14	80
1.4 BiFuel	Petrol/ Compressed Natural Gas (CNG)	55	KFW (TU3JP)		04/03-10/06		DAN1336	14	90
1.6 16V	Petrol	80	NFU (TU5JP4)		09/00-10/02		DAN1063	14	80
1.6 16V	Petrol	80	NFU (TU5JP4)		11/02-03/08		DAN1336	14	90
1.9 D	Diesel	51	WJY (DW8B)		11/02-12/15		DAN1336	14	90
1.9 D 4x4	Diesel	51	WJY (DW8B)		04/04-07/11		DAN1336	14	90
PARTNER / RANCH (08-)									
1.2 THP 110	Petrol	81	HNV (EB2DTM); HNZ (EB2DT)		02/16-		DAN1325	14	150
1.6	Petrol	66	NFR (TU5JP4B)		04/08-		DAN1336	14	90
1.6 VTi 110	Petrol	80	NFU (TU5JP4)		04/08-		DAN1336	14	90
1.6 VTi 90	Petrol	66	NFR (TU5JP4B)		04/08-		DAN1336	14	90
SAAB									
9-3 (02-15)									
1.9 TiD	Diesel	88/110	Z 19 DT;Z 19 DTH		09/04-08/05	Ch No: >51024443	DAN509	14	130
1.9 TiD	Diesel	88/110	Z 19 DT;Z 19 DTH		09/05-02/15	Ch No: 51024444>	DAN1009	14	130
1.9 TTiD	Diesel	132	Z 19 DTR		12/07-02/15		DAN1009	14	130
9-3X (09-15)									
1.9 TTiD AWD	Diesel	132	Z 19 DTR		02/09-12/12		DAN1009	14	130











									
SAAB continued									
9-5 (97-09)									
1.9 T1D	Diesel	110/129	Z 19 DTH;Z 19 DTR		01/06-12/09		DAN1009	14	130
SEAT									
ALHAMBRA (710) (10-)									
2.0 TDI	Diesel	85/100/ 103/125/ 130	CFFA;CFFB;CFFE; CFGB;CFGC;DLUB		06/10-07/15	BO;VA	DAN1328	14	140
2.0 TDI 4Drive	Diesel	103	CFFB		05/11-07/15	BO;VA	DAN1328	14	140
ALTEA (XL) (5P) (04-)									
1.6 TDI	Diesel	66/77	CAYB;CAYC		10/09-07/15	BO;VA;+ SS	DAN1328	14	140
IBIZA IV (6J, 6P) (08-17)									
2.0 TDI	Diesel	105	CFHD		01/10-05/15	BO;VA;+ SS	DAN1328	14	140
LEON (1P) (05-12)									
1.6 TDI	Diesel	66	CAYB		11/10-12/12	+ SS	DAN1328	14	140
1.6 TDI	Diesel	77	CAYC		02/10-12/12	BO;VA;+ SS	DAN1328	14	140
TOLEDO IV (KG3) (12-19)									
1.6 TDI	Diesel	66/77	CAYB;CAYC;CLNA		07/12-06/15	BO;VA;+ SS	DAN1328	14	140
SKODA									
FABIA II (06-14)									
1.6 TDI	Diesel	66/77	CAYB;CAYC		03/10-12/14	BO;VA;+ SS	DAN1328	14	140
OCTAVIA II (1Z) (04-13)									
1.6 TDI	Diesel	77	CAYC		06/09-04/13	BO;VA;+ SS	DAN1328	14	140
1.6 TDI 4x4	Diesel	77	CAYC		06/09-02/13	BO;VA;+ SS	DAN1328	14	140
RAPID (HN) (12-19)									
1.6 TDI	Diesel	66/77	CAYB;CAYC;CLNA		07/12-12/19	BO;VA;+ SS	DAN1328	14	140
ROOMSTER (5J) (06-15)									
1.6 TDI	Diesel	66/77	CAYB;CAYC		03/10-05/15	BO;VA;+ SS	DAN1328	14	140
SUPERB II (3T) (08-15)									
1.6 TDI	Diesel	77	CAYC		09/10-05/15	BO;VA;+ SS	DAN1328	14	140
2.0 TDI	Diesel	103/125	CFFB;CFGB;CLJA		05/13-05/15	BO;VA;+ SS	DAN1328	14	140
2.0 TDI 4x4	Diesel	103/125	CFFB;CFGB		05/13-05/15	BO;VA;+ SS	DAN1328	14	140
YETI (5L) (09-17)									
1.6 TDI	Diesel	77	CAYC		11/10-05/15	BO;VA;+ SS	DAN1328	14	140
2.0 TDI	Diesel	81/103	CFHA;CFHC;CLCA; CLCB		11/09-12/17	BO;VA;+ SS	DAN1328	14	140
2.0 TDI 4x4	Diesel	81/103/ 125	CFHC;CFHF;CFJA; CLCB		11/09-12/17	BO;VA;+ SS	DAN1328	14	140
SUZUKI									
Grand VITARA I (98-06)									
2.5 V6 24V 4x4	Petrol	106/116	H 25 A		04/98-07/03		DAN1006	14	85
2.7	Petrol	127/135	H 27 A		06/01-08/06		DAN1006	14	85
2.7 4x4	Petrol	127/135	H 27 A		09/01-07/03		DAN1006	14	85
Grand VITARA II (05-)									
3.2 AWD	Petrol	171	N32A		01/09-02/15		DAN1143	14	130
IGNIS I (00-05)									
1.3	Petrol	61	M13A		10/00-09/03	JPN	DAN1007	14	75
1.3 4WD	Petrol	61	M13A		10/00-09/03	JPN	DAN1007	14	75
1.5 Sport	Petrol	80	M15A		12/03-12/05	JPN	DAN1007	14	75
IGNIS II (03-)									
1.3	Petrol	69	M13A		09/03-	JPN	DAN1007	14	75
1.3 4x4	Petrol	69	M13A		09/03-	JPN	DAN1007	14	75
1.3 DDiS	Diesel	51	Z13DT		09/03-		DAN1033	14	105
1.5	Petrol	73	M15A		09/03-	JPN	DAN1007	14	75
1.5 4x4	Petrol	73	M15A		09/03-	JPN	DAN1007	14	75
JIMNY (98-)									
1.3	Petrol	63	M13A		08/04-		DAN1007	14	75
1.3 16V	Petrol	60	G13BB		09/98-		DAN1008	14	60
1.3 16V	Petrol	60	M13A		02/01-		DAN1007	14	75
1.3 16V 4WD	Petrol	60	G13BB		09/98-		DAN1008	14	60
1.3 16V 4WD	Petrol	60	M13A		02/01-		DAN1007	14	75
1.3 16V 4x4	Petrol	63	M13A		08/05-		DAN1007	14	75
1.3 4WD	Petrol	62	M13A		03/13-		DAN1007	14	75
1.5 DDiS 4WD	Diesel	48	K9K		02/04-		DAN1007	14	75
1.5 DDiS 4x4	Diesel	63	K9K.2.66		10/05-		DAN1007	14	75
LIANA (01-07)									
1.3	Petrol	66	M13A		07/01-12/07		DAN1007	14	75
1.6	Petrol	76/79	M16A		07/01-12/07		DAN1007	14	75
1.6 4WD	Petrol	76/78	M16A		07/01-12/07		DAN1007	14	75
1.6 i	Petrol	78	M16A		04/02-12/07		DAN1007	14	75
SPLASH (08-)									
1.3 CDTI	Diesel	55	D13A;Z 13 DTJ		01/08-		DAN1033	14	105







         									
SUZUKI continued									
SWIFT III (05-)									
1.3	Petrol	68	M13A		02/05-	JPN;TYPE 1;TYPE 2	DAN1007	14	75
1.3	Petrol	68	M13A		02/05-	JPN;TYPE 3;TYPE 4	DAN1357	14	75
1.3 4x4	Petrol	66/68	M13A		02/05-	JPN;TYPE 1;TYPE 2	DAN1007	14	75
1.3 4x4	Petrol	66/68	M13A		02/05-	JPN;TYPE 3;TYPE 4	DAN1357	14	75
1.3 DDiS	Diesel	51/55	D13A;Z 13 DTJ;Z13DT		08/05-		DAN1033	14	105
1.5	Petrol	75	M15A		02/05-	JPN;TYPE 1;TYPE 2	DAN1007	14	75
1.5	Petrol	75	M15A		02/05-	JPN;TYPE 3;TYPE 4	DAN1357	14	75
SX4 (06-)									
1.5	Petrol	73	M15A		06/06-07/10	JPN	DAN1357	14	75
1.5 VVT	Petrol	82	M15A		07/10-	JPN	DAN1357	14	75
1.5 VVT 4x4	Petrol	82	M15A		07/10-	JPN	DAN1357	14	75
1.6	Petrol	79/88	M16A		10/07-		DAN1357	14	75
1.6 VVT	Petrol	79/88	M16A		06/06-		DAN1357	14	75
1.6 VVT 4x4	Petrol	79/82/88	M16A		06/06-		DAN1357	14	75
1.9 DDiS	Diesel	88	D19AA		06/06-		DAN1062	14	140
1.9 DDiS 4x4	Diesel	88	D19AA		06/06-		DAN1062	14	140
SX4 S-Cross (13-)									
1.6	Petrol	86/88	M16A		08/13-		DAN1316	14	100
1.6 AWD	Petrol	86/88	M16A		08/13-		DAN1316	14	100
1.6 DDiS	Diesel	88	D16AA		08/13-		DAN1305	14	120
1.6 DDiS AWD	Diesel	88	D16AA		08/13-		DAN1305	14	120
VITARA (88-99)									
2.0 V6 24V AWD	Petrol	100	H 20 A		03/95-03/98		DAN1006	14	85
2.5 V6 24V AWD	Petrol	118	H 25 A		12/95-03/98		DAN1006	14	85
VITARA (15-)									
1.6	Petrol	86/88	M16A		02/15-		DAN1316	14	100
1.6 AWD	Petrol	86/88	M16A		02/15-		DAN1316	14	100
1.6 DDiS	Diesel	88	D16AA		02/15-		DAN1305	14	120
1.6 DDiS AWD	Diesel	88	D16AA		02/15-		DAN1305	14	120
WAGON R+ (98-00)									
1.0	Petrol	48	K10A		02/98-05/00		DAN1008	14	60
WAGON R+ (00-)									
1.3 DDiS	Diesel	51	Z13DT		09/03-		DAN1033	14	105
TOYOTA									
4 RUNNER (N21) (02-09)									
4.0	Petrol	174/183	1GR-FE		11/02-09/09		DAN1080	14	80
4.0 4WD	Petrol	183	1GR-FE		01/03-12/09		DAN1080	14	80
4 RUNNER (N28) (10-)									
4.0	Petrol	202	1GR-FE		01/10-		DAN1484	14	150
ALPHARD II (08-14)									
2.4	Petrol	123/125	2AZ-FE		04/08-12/14		DAN1482	14	150
2.4 4WD	Petrol	125	2AZ-FE		05/08-12/14		DAN1482	14	150
AURIS (E15) (06-12)									
1.33 Dual-VVTi	Petrol	74	1NR-FE		05/09-09/12	- SS	DAN1042	14	80
1.33 Dual-VVTi	Petrol	74	1NR-FE		05/09-09/12	- SS;+ Co	DAN1015	14	100
1.33 Dual-VVTi	Petrol	74	1NR-FE		05/09-09/12	+ SS	DAN1012	14	100
1.4	Petrol	71	4ZZ-FE		03/07-10/08	EUR	DAN1021	14	90
1.4	Petrol	71	4ZZ-FE		03/07-12/08	JPN	DAN1079	14	80
1.4 D-4D	Diesel	66	1ND-TV		03/07-12/08	JPN	DAN1076	14	100
1.4 D-4D	Diesel	66	1ND-TV		03/07-02/09	EUR	DAN1076	14	100
1.4 D-4D	Diesel	66	1ND-TV		12/08-08/12	JPN	DAN1018	14	100
1.4 D-4D	Diesel	66	1ND-TV		02/09-09/12		DAN1018	14	100
1.4 D-4D	Diesel	66	1ND-TV		02/09-09/12	EUR	DAN1018	14	100
1.6	Petrol	91	1ZR-FE		03/07-01/09		DAN1061	14	90
1.6	Petrol	91	1ZR-FE		03/07-09/12		DAN1019	14	100
1.6	Petrol	97	1ZR-FAE		05/09-09/12		DAN1057	14	90
1.6	Petrol	97	1ZR-FAE		05/09-09/12		DAN1011	14	100
1.8	Petrol	106/108	2ZR-FAE		02/09-09/12		DAN1057	14	90
1.8	Petrol	106/108	2ZR-FAE		02/09-09/12		DAN1011	14	100
1.8 4WD	Petrol	100	2ZR-FE		10/06-10/09		DAN1057	14	90
1.8 4WD	Petrol	100	2ZR-FE		10/06-10/09		DAN1011	14	100
2.0 D-4D	Diesel	93	1AD-FTV		10/06-03/09		DAN1351	14	100
2.0 D-4D	Diesel	93	1AD-FTV		03/09-09/12		DAN938	14	100
2.2 D	Diesel	130	2AD-FHV		11/06-03/09		DAN1351	14	100
2.2 D	Diesel	130	2AD-FHV		03/09-09/12		DAN938	14	100
AURIS (E18) (12-18)									
1.3	Petrol	73	1NR-FE		10/12-12/18	- SS;LHD	DAN1309	14	100











										
TOYOTA continued										
AURIS (E18) (12-18) continued										
1.3	Petrol	73	1NR-FE		10/12-12/18	+ SS,+ Co;LHD		DAN1093	14	100
1.3	Petrol	73	1NR-FE		10/12-12/18	+ SS;LHD		DAN1100	14	80
1.3	Petrol	73	1NR-FE		10/12-12/18	RHD		DAN1093	14	100
1.4 D-4D	Diesel	66	1ND-TV		10/12-05/15			DAN1094	14	100
1.6	Petrol	97	1ZR-FAE		10/12-05/15			DAN1096	14	90
1.6	Petrol	97	1ZR-FAE		10/12-05/15	+ Co		DAN1098	14	100
2.0 D-4D	Diesel	91	1AD-FTV		10/12-04/15			DAN1095	14	100
AVENSIS (97-03)										
2.0	Petrol	110	1AZ-FSE		10/00-02/03			DAN1434	14	100
2.0 D	Diesel	85	1CD-FTV		09/02-02/03			DAN939	14	120
2.0 D-4D	Diesel	81	1CD-FTV		10/99-02/03			DAN939	14	120
2.0 VVT-i	Petrol	110	1AZ-FSE		10/00-02/03			DAN1434	14	100
AVENSIS (03-09)										
1.6 VVT-i	Petrol	81	3ZZ-FE		04/03-11/08			DAN1021	14	90
1.8	Petrol	95	1ZZ-FE		03/03-11/08			DAN1021	14	90
2.0 D-4D	Diesel	85	1CD-FTV		04/03-04/06			DAN945	14	130
2.0 D-4D	Diesel	93	1AD-FTV		03/06-11/08			DAN938	14	100
2.2 D-4D	Diesel	110	2AD-FTV		10/05-11/08			DAN938	14	100
2.2 D-CAT	Diesel	130	2AD-FHV		07/05-11/08			DAN938	14	100
AVENSIS (08-18)										
1.6	Petrol	97	1ZR-FAE		11/08-11/11			DAN1011	14	100
1.6	Petrol	97	1ZR-FAE		11/11-05/15			DAN1318	14	100
1.8	Petrol	108	2ZR-FAE		11/08-11/11			DAN1011	14	100
1.8	Petrol	108	2ZR-FAE		11/11-05/15			DAN1318	14	100
2.0	Petrol	112	3ZR-FAE;3ZR-FE		11/08-11/11			DAN1011	14	100
2.0	Petrol	112	3ZR-FAE;3ZR-FE		11/11-10/18			DAN1318	14	100
2.0 D-4D	Diesel	91/93	1AD-FTV		11/08-05/15	+ Co		DAN1013	14	130
2.0 D-4D	Diesel	91/93	1AD-FTV		11/11-05/15			DAN1317	14	100
2.0 D-4D	Diesel	93	1AD-FTV		11/08-11/11			DAN938	14	100
2.0 D-4D	Diesel	93	1AD-FTV		11/08-11/11	Refillable Batt.		DAN1045	14	100
2.2 D-4D	Diesel	110/130	2AD-FHV	ATM	11/08-05/15			DAN1013	14	130
2.2 D-4D	Diesel	110/130	2AD-FHV;2AD-FTV	MTM	11/08-11/11			DAN938	14	100
2.2 D-4D	Diesel	110/130	2AD-FHV;2AD-FTV	MTM	11/08-05/15	+ Co		DAN1013	14	130
2.2 D-4D	Diesel	110/130	2AD-FHV;2AD-FTV	MTM	11/11-05/15			DAN1317	14	100
AVENSIS Verso (01-09)										
2.0	Petrol	110	1AZ-FE		08/01-11/09			DAN952	14	100
2.0 D	Diesel	85	1CD-FTV		08/01-08/05			DAN1345	14	130
AYGO (05-14)										
1.0	Petrol	50	1KR-FE		07/05-05/14			DAN1035	14	70
1.0	Petrol	50	1KR-FE		07/05-05/14	+ Co;+ Ho		DAN1036	14	80
1.0 GPL	Petrol/ Liquified Petroleum Gas (LPG)	50	1KR-FE		09/07-05/14			DAN1035	14	70
CAMRY (V3) (01-06)										
2.0 VVTi	Petrol	110	1AZ-FE		08/01-07/03			DAN951	14	90
2.0 VVTi	Petrol	110	1AZ-FE		07/03-01/06			DAN1282	14	80
2.4	Petrol	112	2AZ-FE		11/01-07/03			DAN951	14	90
2.4	Petrol	112	2AZ-FE		07/03-01/06			DAN1282	14	80
CELICA (99-05)										
1.8 16V TS	Petrol	141	2ZZ-GE	MTM	08/99-09/05			DAN944	14	80
1.8 16V VT-i	Petrol	105	1ZZ-FE		08/99-07/05			DAN948	14	80
COROLLA (E11) (97-02)										
1.4	Petrol	71	4ZZ-FE	MTM	10/99-09/01	JPN		DAN943	14	70
1.4 16V	Petrol	71	4ZZ-FE	5MTM	02/00-09/01			DAN943	14	70
1.6	Petrol	81	3ZZ-FE	ATM	10/99-09/01	JPN		DAN948	14	80
1.6	Petrol	81	3ZZ-FE	MTM	10/99-09/01	JPN		DAN943	14	70
1.6 16V	Petrol	81	3ZZ-FE	4ATM	10/99-09/01			DAN948	14	80
1.6 16V	Petrol	81	3ZZ-FE	5MTM	10/99-09/01			DAN943	14	70
2.0 D-4D	Diesel	66	1CD-FTV		09/00-09/01			DAN939	14	120
COROLLA (E12) (01-07)										
1.4 D	Diesel	66	1ND-TV		07/04-02/07			DAN1076	14	100
1.4 D-4D	Diesel	66	1ND-TV		06/04-10/06			DAN1076	14	100
1.4 D4-D	Diesel	66	1ND-TV		06/04-10/07			DAN1076	14	100
1.4 VVT-i	Petrol	71	4ZZ-FE	4ATM	10/01-10/06	JPN		DAN948	14	80
1.4 VVT-i	Petrol	71	4ZZ-FE	5MTM	10/01-10/06	JPN		DAN943	14	70











Starters & Alternators











Application Tables - Alternators











									
TOYOTA continued									
COROLLA (E12) (01-07) continued									
1.4 VWT-i	Petrol	71	4ZZ-FE		05/04-02/07	EUR	DAN1021	14	90
1.6 VWT-i	Petrol	81	3ZZ-FE	4ATM	10/01-10/06	JPN	DAN948	14	80
1.6 VWT-i	Petrol	81	3ZZ-FE	5MTM	10/01-10/06	JPN	DAN943	14	70
1.6 VWT-i	Petrol	81	3ZZ-FE		05/04-08/07	EUR	DAN1021	14	90
1.8 WTL-i TS	Petrol	141/160/165	2ZZ-GE		11/01-02/07		DAN944	14	80
2.0 D-4D	Diesel	66/81/85	1CD-FTV		01/02-02/07		DAN945	14	130
COROLLA (E14, E15) (06-14)									
1.33	Petrol	74	1NR-FE		12/08-11/12	- SS	DAN1042	14	80
1.33	Petrol	74	1NR-FE		12/08-11/12	- SS;+ Co	DAN1015	14	100
1.33	Petrol	74	1NR-FE		12/08-11/12	+ SS	DAN1012	14	100
1.4 D-4D	Diesel	66	1ND-TV		10/06-12/08	JPN	DAN1076	14	100
1.4 D-4D	Diesel	66	1ND-TV		02/08-02/09	ZAF	DAN1076	14	100
1.4 D-4D	Diesel	66	1ND-TV		12/08-04/13	JPN	DAN1018	14	100
1.4 D-4D	Diesel	66	1ND-TV		02/09-06/13	ZAF	DAN1018	14	100
1.4 VWT-i	Petrol	71	4ZZ-FE		11/06-12/08	JPN	DAN1079	14	80
1.4 VWT-i	Petrol	71	4ZZ-FE		02/08-02/09	ZAF	DAN1021	14	90
1.6	Petrol	97	1ZR-FAE		11/06-05/13		DAN1057	14	90
1.6	Petrol	97	1ZR-FAE		11/06-05/13		DAN1011	14	100
1.6	Petrol	97	1ZR-FE		11/06-02/09		DAN1061	14	90
1.6	Petrol	97	1ZR-FE		11/06-05/13		DAN1019	14	100
1.6 Dual VVTi	Petrol	91	1ZR-FE		01/07-05/13		DAN1019	14	100
1.6 Dual VVTi	Petrol	91	1ZR-FE		02/08-02/09		DAN1061	14	90
1.6 VVTi	Petrol	90	ZRE151		07/10-05/14		DAN1019	14	100
1.8	Petrol	99/100	1ZZ-FE;2ZR-FE		10/06-07/14		DAN1021	14	90
1.8 VVTi	Petrol	97	1ZZ-FE		01/08-07/14		DAN1021	14	90
2.0 D-4D	Diesel	93	1AD-FTV		11/06-03/09		DAN1351	14	100
2.0 D-4D	Diesel	93	1AD-FTV		03/09-05/13		DAN938	14	100
COROLLA (E18) (13-18)									
1.3	Petrol	73	1NR-FE		06/13-12/18	+ Co;LHD	DAN1093	14	100
1.3	Petrol	73	1NR-FE		06/13-12/18	+ Co;LHD;EU4	DAN1309	14	100
1.3	Petrol	73	1NR-FE		06/13-12/18	LHD	DAN1100	14	80
1.3	Petrol	73	1NR-FE		06/13-12/18	RHD	DAN1093	14	100
1.4 D-4D	Diesel	66	1ND-TV		06/13-05/15		DAN1094	14	100
1.6	Petrol	97	1ZR-FAE		06/13-05/15		DAN1096	14	90
1.6	Petrol	97	1ZR-FAE		06/13-05/15	+ Co	DAN1098	14	100
COROLLA Verso (E12) (01-09)									
1.6	Petrol	81	3ZZ-FE		08/01-01/04		DAN948	14	80
1.6	Petrol	81	3ZZ-FE		04/04-01/09		DAN1021	14	90
1.8	Petrol	95	1ZZ-FE		04/04-01/09		DAN1021	14	90
1.8 VWT-i	Petrol	99	1ZZ-FE		12/01-01/04		DAN948	14	80
2.0 D-4D	Diesel	66/85	1CD-FTV		01/02-08/05		DAN945	14	130
2.2 D-4D	Diesel	100/130	2AD-FHV;2AD-FTV		10/05-03/09		DAN938	14	100
2.2 D-4D	Diesel	100/130	2AD-FHV;2AD-FTV		10/05-03/09	+ Co	DAN1013	14	130
CROWN (10-12)									
3.0	Petrol	167	3GR-FE		09/10-12/12		DAN1483	14	150
DYNA (01-)									
2.5 D-4D	Diesel	65/75	2KD-FTV		07/01-10/06		DAN1349	14	70
3.0 D-4D	Diesel	80/100/106	1KD-FTV		09/06-		DAN1070	14	100
HIACE IV (87-12)									
2.5 D-4D	Diesel	65/70/75/86	2KD-FTV		08/01-12/12		DAN1347	14	80
2.5 D-4D	Diesel	65/75	2KD-FTV		08/01-05/04		DAN1349	14	70
2.5 D-4D 4WD	Diesel	65/75	2KD-FTV		08/01-05/04		DAN1349	14	70
2.5 D-4D 4WD	Diesel	65/75/86	2KD-FTV		08/01-12/12		DAN1347	14	80
HIACE V (04-)									
2.5 D-4D	Diesel	70/75/86	2KD-FTV		06/04-		DAN1347	14	80
2.5 D-4D	Diesel	70/75/86	2KD-FTV		06/04-		DAN1070	14	100
2.5 D-4D	Diesel	70/75/86	2KD-FTV		06/04-		DAN1069	14	130
2.5 D-4D	Diesel	70/75/86	2KD-FTV		06/04-	+ JPN	DAN1481	14	130
2.5 D-4D 4WD	Diesel	94	2KD-FTV		08/04-09/07		DAN1347	14	80
2.5 D-4D 4WD	Diesel	94	2KD-FTV		08/04-09/07		DAN1070	14	100
2.5 D-4D 4WD	Diesel	94	2KD-FTV		08/04-09/07		DAN1069	14	130
2.5 D-4D 4WD	Diesel	94	2KD-FTV		08/04-09/07	+ JPN	DAN1481	14	130
3.0 D	Diesel	75/100	1KD-FTV		01/05-	+ JPN	DAN1481	14	130
HILUX II (83-05)									
2.5 D-4D	Diesel	65	2KD-FTV		11/01-07/05		DAN1349	14	70











									
TOYOTA continued									
HILUX II (83-05) continued									
2.5 D-4D 4WD	Diesel	75	2KD-FTV		11/01-07/05		DAN1349	14	70
HILUX III (05-)									
2.5 D 4WD	Diesel	75	2KD-FTV		03/05-05/15		DAN1347	14	80
2.5 D-4D	Diesel	75/88/ 106	2KD-FTV		03/05-05/15		DAN1347	14	80
2.5 D-4D 4WD	Diesel	88/94/ 106	2KD-FTV		11/04-05/15		DAN1347	14	80
3.0 D-4D 4WD	Diesel	126	1KD-FTV		08/05-09/15		DAN1347	14	80
IQ (09-15)									
1.0	Petrol	50	1KR-FE		01/09-12/15		DAN1081	14	80
1.33	Petrol	72	1NR-FE	ATM	01/09-05/14	N Type	DAN1212	14	80
1.33	Petrol	72	1NR-FE	MTM	01/09-05/14	R Type	DAN1212	14	80
LAND CRUISER (J80) (90-98)									
4.2 D	Diesel	99	1H-Z		08/92-12/97		DAN1114	14	80
4.2 TD	Diesel	118/123	1HD-T		08/92-12/97		DAN1114	14	80
4.2 TD 24V	Diesel	125	1HD-FT		01/95-12/97		DAN1114	14	80
LAND CRUISER (J100) (98-08)									
4.2 TD	Diesel	150	1HD-FTE		01/98-08/07		DAN1114	14	80
LAND CRUISER (J200) (07-)									
4.5 D V8	Diesel	210	1VD-FTV		01/08-		DAN1209	14	180
4.5 D-4D	Diesel	195	1VD-FTV		09/07-		DAN1209	14	180
4.5 D4-D	Diesel	171/173/ 183/200	1VD-FTV		08/07-		DAN1209	14	180
4.6 V8	Petrol	234	1UR-FE		01/12-	- HWS	DAN1205	14	150
4.6 V8	Petrol	234	1UR-FE		01/13-	+ HWS	DAN1208	14	180
LAND CRUISER / PRADO (J70) (84-06)									
4.0 4x4	Petrol	170	1GR-FE		07/09-08/14		DAN1080	14	80
LAND CRUISER / PRADO (J120) (02-10)									
3.0 D-4D	Diesel	92/120/ 122/127/ 150	1KD-FTV;1KZ-TE		09/02-12/10		DAN1347	14	80
3.0 D-4D	Diesel	120/122/ 127/150	1KD-FTV		09/02-12/10		DAN1070	14	100
3.0 D-4D	Diesel	120/122/ 127/150	1KD-FTV		09/02-12/10	+ Co	DAN1069	14	130
4.0	Petrol	179/183/ 203/207	1GR-FE		09/02-12/10		DAN1080	14	80
LAND CRUISER / PRADO (J150) (10-)									
3.0 D-4D	Diesel	127/140	1KD-FTV		08/09-		DAN1070	14	100
3.0 D-4D	Diesel	127/140	1KD-FTV		08/09-		DAN1069	14	130
3.0 D4d 4WD	Diesel	140	1KD-FTV		01/11-		DAN1070	14	100
3.0 D4d 4WD	Diesel	140	1KD-FTV		01/11-		DAN1069	14	130
4.0 V6 Dual VVTi	Petrol	205	1GR-FE		08/09-		DAN1484	14	150
4.0 V6 VVTi	Petrol	183	1GR-FE		11/12-		DAN1484	14	150
4.0 V6 VVT-i	Petrol	207	1GR-FE		08/09-		DAN1484	14	150
LAND CRUISER / PRADO / COLORADO (J90) (95-02)									
3.0 D-4D 4WD	Diesel	120	1KD-FTV		08/00-08/02		DAN1347	14	80
MARK X II (09-)									
2.5	Petrol	149	4GR-FSE		11/12-		DAN1483	14	150
MR 2 III (99-07)									
1.8 16V VT-i	Petrol	103	1ZZ-FE		12/99-09/05		DAN948	14	80
PREVIA / ESTIMA II (00-06)									
2.0 D-4D	Diesel	85	1CD-FTV		03/01-01/06		DAN1345	14	130
2.4	Petrol	115/125	2AZ-FE		02/00-02/06		DAN952	14	100
2.4 4WD	Petrol	125	2AZ-FE		02/00-01/06		DAN952	14	100
PREVIA / ESTIMA III (05-)									
2.4	Petrol	125	2AZ-FE		10/05-		DAN1482	14	150
2.4 4WD	Petrol	125	2AZ-FE		01/06-		DAN1482	14	150
RAV 4 I / FUNCRAISER (94-00)									
2.0 4WD	Petrol	94/99	3S-FE	ATM	01/94-06/00		DAN955	14	80
RAV 4 II (00-05)									
1.8	Petrol	92	1ZZ-FE		08/00-11/05		DAN948	14	80
2.0 4WD	Petrol	110	1AZ-FE;1AZ-FSE	ATM	05/00-07/03		DAN1434	14	100
2.0 4WD	Petrol	110	1AZ-FE;1AZ-FSE	MTM	05/00-11/05		DAN951	14	90
2.0 4WD	Petrol	110	1AZ-FE;1AZ-FSE	ATM	07/03-11/05		DAN952	14	100
2.0 D 4WD	Diesel	85	1CD-FTV		05/01-11/05		DAN1345	14	130
RAV 4 III (05-13)									
2.0	Petrol	109/116	3ZR-FAE		12/08-06/13		DAN1011	14	100
2.0 4WD	Petrol	109/116	3ZR-FAE		12/08-06/13		DAN1011	14	100
2.0 4WD	Petrol	112	1AZ-FE		02/06-12/12		DAN1052	14	100











									
TOYOTA continued									
RAV 4 III (05-13) continued									
2.0 4WD	Petrol	112	1AZ-FE		12/09-12/12	EU4	DAN952	14	100
2.2 D	Diesel	110	2AD-FHV;2AD-FTV		12/08-06/13		DAN1350	14	150
2.2 D 4WD	Diesel	98/100/ 110/130	2AD-FHV;2AD-FTV		12/08-06/13		DAN1350	14	150
2.2 D 4WD	Diesel	98/100/ 130	2AD-FHV;2AD-FTV		11/05-12/08		DAN1013	14	130
RAV 4 IV (12-)									
2.0 4WD	Petrol	111	3ZR-FAE		12/12-04/15		DAN1098	14	100
2.0 VVT-i	Petrol	107	3ZR-FAE		12/12-04/15		DAN1098	14	100
2.2 D 4WD	Diesel	110/130	2AD-FHV;2AD-FTV		12/12-		DAN1350	14	150
TUNDRA (99-06)									
4.0	Petrol	180	1GR-FE		08/04-08/05		DAN1080	14	80
4.0 4WD	Petrol	180	1GR-FE		08/04-08/05		DAN1080	14	80
URBAN CRUISER (07-16)									
1.33	Petrol	74	1NR-FE		01/09-03/16	- SS	DAN1042	14	80
1.33	Petrol	74	1NR-FE		01/09-03/16	- SS;+ Co	DAN1015	14	100
1.33	Petrol	74	1NR-FE		01/09-03/16	+ SS	DAN1025	14	80
1.33	Petrol	74	1NR-FE		01/09-03/16	+ SS;+ Co	DAN1012	14	100
1.33	Petrol	74	1NR-FE		04/09-03/16		DAN1042	14	80
1.33	Petrol	74	1NR-FE		04/09-03/16	+ Co	DAN1015	14	100
1.4 D-4D	Diesel	66	1ND-TV		01/09-04/14		DAN1018	14	100
1.4 D-4D 4WD	Diesel	66	1ND-TV		01/09-04/14		DAN1018	14	100
VERSO (09-18)									
1.6	Petrol	81/97	1ZR-FAE		04/09-04/12		DAN1011	14	100
1.6	Petrol	81/97	1ZR-FAE		04/12-03/15		DAN1318	14	100
1.8	Petrol	108	2ZR-FAE		04/09-04/12		DAN1011	14	100
1.8	Petrol	108	2ZR-FAE		04/12-03/15		DAN1318	14	100
2.0 D-4D	Diesel	91/93	1AD-FTV		04/09-03/15	+ Co	DAN1013	14	130
2.0 D-4D	Diesel	91/93	1AD-FTV		04/12-03/15		DAN1317	14	100
2.0 D-4D	Diesel	93	1AD-FTV		04/09-04/12		DAN938	14	100
2.2 D-4D	Diesel	100	2AD-FHV		04/09-03/15		DAN1013	14	130
2.2 D-4D	Diesel	110	2AD-FHV		04/09-04/12		DAN938	14	100
2.2 D-4D	Diesel	110	2AD-FHV		04/09-03/15	+ Co	DAN1013	14	130
2.2 D-4D	Diesel	110	2AD-FHV		04/12-03/15		DAN1317	14	100
2.2 D-CAT	Diesel	130	2AD-FHV		04/09-04/12		DAN938	14	100
2.2 D-CAT	Diesel	130	2AD-FHV		04/09-03/15	+ Co	DAN1013	14	130
2.2 D-CAT	Diesel	130	2AD-FHV		04/12-03/15		DAN1317	14	100
VERSO S (10-16)									
1.4 D4-D	Diesel	66	1ND-TV		11/10-10/16		DAN1094	14	100
VIOS / YARIS (07-13)									
1.0	Petrol	52	1KR-FE		09/05-10/13		DAN1020	14	80
YARIS (99-05)									
1.0	Petrol	48	1SZ-FE		03/03-09/05	- AC	DAN962	14	70
1.0	Petrol	50	1SZ-FE		04/99-12/02	- AC;- PS;JPN	DAN962	14	70
1.0	Petrol	50	1SZ-FE		04/99-12/02	- AC;+ PS;JPN	DAN960	14	70
1.0	Petrol	50	1SZ-FE		04/99-12/02	+ AC;- PS;JPN	DAN960	14	70
1.0	Petrol	50	1SZ-FE		04/99-12/02	+ AC;+ PS;JPN	DAN961	14	90
1.0	Petrol	50	1SZ-FE		01/01-09/05	- AC;FRA	DAN962	14	70
1.3	Petrol	64	2NZ-FE		08/99-01/03	- AC	DAN966	14	70
1.3	Petrol	64	2NZ-FE		08/99-01/03	+ AC	DAN959	14	80
1.3	Petrol	64	2SZ-FE		04/02-09/05	- AC	DAN962	14	70
1.4 D-4D	Diesel	55	1ND-TV		10/01-09/05	- AC	DAN964	14	70
1.4 D-4D	Diesel	55	1ND-TV		10/01-09/05	+ AC	DAN950	14	90
1.5	Petrol	77/110	1NZ-FE		03/00-11/05		DAN959	14	80
YARIS (05-11)									
1.0 GPL	Petrol/ Liquified Petroleum Gas (LPG)	51	1KR-FE		01/06-07/11		DAN1020	14	80
1.0 VVT-i	Petrol	51	1KR-FE		08/05-08/08	JPN	DAN1077	14	80
1.0 VVT-i	Petrol	51	1KR-FE		08/05-11/08	FRA	DAN1077	14	80
1.0 VVT-i	Petrol	51	1KR-FE		08/08-06/11	+ Co;JPN	DAN1017	14	100
1.0 VVT-i	Petrol	51	1KR-FE		08/08-06/11	JPN	DAN1020	14	80
1.0 VVT-i	Petrol	51	1KR-FE		11/08-07/11	+ Co;FRA	DAN1017	14	100
1.0 VVT-i	Petrol	51	1KR-FE		11/08-07/11	FRA	DAN1020	14	80
1.33 VVT-i	Petrol	74	1NR-FE	SMT	11/08-07/11		DAN1025	14	80
1.33 VVT-i	Petrol	74	1NR-FE	MTM	11/08-07/11	- SS	DAN1042	14	80









										
TOYOTA continued										
YARIS (05-11) continued										
1.33 VVT-i	Petrol	74	1NR-FE	MTM	11/08-07/11	- SS;+ Co		DAN1015	14	100
1.33 VVT-i	Petrol	74	1NR-FE	SMT	11/08-07/11	+ Co		DAN1012	14	100
1.33 VVT-i	Petrol	74	1NR-FE	MTM	11/08-07/11	+ SS		DAN1025	14	80
1.33 VVT-i	Petrol	74	1NR-FE	MTM	11/08-07/11	+ SS;+ Co		DAN1012	14	100
1.4 D-4D	Diesel	66	1ND-TV		11/08-07/11			DAN1018	14	100
1.8 VTi	Petrol	98	2ZR-FE		01/07-12/11			DAN1019	14	100
YARIS (10-)										
1.0	Petrol	51	1KR-FE		12/10-	+ Co		DAN1315	14	100
1.0	Petrol	53	1KR-FE		06/18-			DAN1315	14	100
1.3	Petrol	73	1NR-FE		09/11-	+ Co		DAN1093	14	100
1.3 4WD	Petrol	70	1NR-FE		12/10-	+ Co		DAN1093	14	100
1.4 D	Diesel	66	1ND-TV		09/11-05/15			DAN1094	14	100
1.8 GRMN	Petrol	156	2ZR-FE (SC)		09/17-			DAN1011	14	100
YARIS VERSO (99-05)										
1.3	Petrol	62	2NZ-FE		08/99-09/05			DAN966	14	70
1.3	Petrol	62	2NZ-FE		08/99-09/05			DAN959	14	80
1.4 D-4D	Diesel	55	1ND-TV		09/00-09/05			DAN950	14	90
1.5	Petrol	77	1NZ-FE		03/00-09/05			DAN959	14	80
VAUXHALL										
AGILA I (A) (00-08)										
1.0 12V	Petrol	43	Z 10 XEP		02/00-11/06	2 pin plug		DAN1055	14	70
1.2 16V Twinport	Petrol	59	Z 12 XEP		07/04-11/06			DAN1055	14	70
ASTRA III (F) (91-01)										
1.4 i	Petrol	44/60	C 14 NZ;C 14 SE; X 14 NZ		03/91-09/98	+ PS		DAN1342	14	100
1.4 i	Petrol	44/60	C 14 NZ;C 14 SE; X 14 NZ		09/94-09/98	- PS		DAN1343	14	70
1.4 i 16V	Petrol	66	X 14 XE		02/96-09/98			DAN1342	14	100
1.6 i	Petrol	52/55/74	C 16 NZ;C 16 SE; X 16 SZ;X 16 SZR		09/91-03/01	+ PS		DAN1342	14	100
1.6 i	Petrol	52/55/74	C 16 NZ;C 16 SE; X 16 SZ;X 16 SZR		09/94-03/01	- PS		DAN1343	14	70
1.6 i 16V	Petrol	74	X 16 XEL		01/94-09/98			DAN1342	14	100
1.6 Si	Petrol	74	C 16 SE		03/91-12/94	+ PS		DAN1342	14	100
1.6 Si	Petrol	74	C 16 SE		09/94-12/94	- PS		DAN1343	14	70
1.8	Petrol	92	C 18 XE		09/94-08/96			DAN1342	14	100
1.8 16V	Petrol	85	C 18 XEL;X 18 XE		11/94-03/01			DAN1342	14	100
1.8 i	Petrol	66	C 18 NZ		09/92-09/98			DAN1342	14	100
1.8 i 16V	Petrol	85/92	C 18 XE;C 18 XEL		06/93-02/98			DAN1342	14	100
2.0 i	Petrol	85	C 20 NE		09/92-09/98			DAN1342	14	100
2.0 i 16V	Petrol	100/110	C 20 XE;X 20 XEV		09/91-09/98			DAN1342	14	100
ASTRA IV (G) (98-06)										
1.4 16V	Petrol	66	X 14 XE;Z 14 XE		02/98-05/05			DAN1341	14	100
1.6	Petrol	55/62	X 16 SZR;Z 16 SE		02/98-05/05			DAN1341	14	100
1.6 16V	Petrol	74	C 16 SEL;X 16 XEL; Z 16 XE		02/98-10/05			DAN1341	14	100
1.6 Dualfuel	Petrol/ Liquified Petroleum Gas (LPG)	62	Z 16 SE		03/98-05/05			DAN1341	14	100
1.6 i	Petrol	55/62	X 16 SZR;Z 16 SE		08/98-08/06			DAN1341	14	100
1.8 16V	Petrol	85/92	X 18 XE1;Z 18 XE		02/98-10/05			DAN1341	14	100
1.8 16V DualFuel	Petrol/ Liquified Petroleum Gas (LPG)	87	Z 18 XE		02/98-08/05			DAN1341	14	100
2.0	Petrol	147	Z 20 LET		09/02-10/05			DAN1341	14	100
2.0 16V	Petrol	100	X 20 XEV		02/98-05/05			DAN1341	14	100
2.0 16V Turbo	Petrol	140	Z 20 LET		09/00-08/05			DAN1341	14	100
2.0 SRI Turbo	Petrol	141	Z 20 LET		11/01-05/05			DAN1341	14	100
2.0 Turbo	Petrol	141	Z 20 LET		03/02-10/05			DAN1341	14	100
ASTRA V (H) (04-10)										
1.3 CDTI	Diesel	66	Z 13 DTH		01/04-12/13			DAN1032	14	70
1.3 CDTI	Diesel	66	Z 13 DTH		01/04-12/13			DAN1033	14	105
1.3 CDTI	Diesel	66	Z 13 DTH		01/04-12/13			DAN1034	14	120
1.4	Petrol	66	Z 14 XEP		01/04-05/09	2 pin plug		DAN1055	14	70
1.4	Petrol	66	Z 14 XEP		01/04-05/09	2 pin plug		DAN1340	14	100











											
VAUXHALL continued											
ASTRA V (H) (04-10) continued											
1.4 i	Petrol	66	Z 14 XEP		03/05-12/13	2 pin plug		DAN1055	14	70	
1.4 i	Petrol	66	Z 14 XEP		03/05-12/13	2 pin plug		DAN1340	14	100	
1.4 i 16V	Petrol	66	Z 14 XEP		03/05-11/10	2 pin plug		DAN1055	14	70	
1.4 i 16V	Petrol	66	Z 14 XEP		03/05-11/10	2 pin plug		DAN1340	14	100	
1.8	Petrol	92	Z 18 XE		01/04-11/10			DAN1341	14	100	
1.9 CDTI	Diesel	74	Z 19 DTL		08/05-11/10	Ch No: >72207929; 75189052;78104400;7G		DAN510	14	105	
1.9 CDTI	Diesel	74	Z 19 DTL		08/05-11/10	Ch No: >72207929; 75189052;78104400;7G		DAN506	14	120	
1.9 CDTI	Diesel	74	Z 19 DTL		08/05-11/10	Ch No: >72207929; 75189052;78104400;7G		DAN509	14	130	
1.9 CDTI	Diesel	110	Z 19 DTH		01/04-11/11	Ch No: >72212298; 75189052;78104400;7G		DAN510	14	105	
1.9 CDTI	Diesel	110	Z 19 DTH		01/04-11/11	Ch No: >72212298; 75189052;78104400;7G		DAN506	14	120	
1.9 CDTI	Diesel	110	Z 19 DTH		01/04-11/11	Ch No: >72212298; 75189052;78104400;7G		DAN509	14	130	
1.9 CDTI 16V	Diesel	88	Z 19 DTJ		01/04-05/09	Ch No: >72212298; 75189052;78104400;7G		DAN510	14	105	
1.9 CDTI 16V	Diesel	88	Z 19 DTJ		01/04-05/09	Ch No: >72212298; 75189052;78104400;7G		DAN506	14	120	
1.9 CDTI 16V	Diesel	88	Z 19 DTJ		01/04-05/09	Ch No: >72212298; 75189052;78104400;7G		DAN509	14	130	
1.9 CDTI 8V	Diesel	88	Z 19 DT		01/04-11/11	+ MY2007;- POC: WFJ		DAN506	14	120	
1.9 CDTI 8V	Diesel	88	Z 19 DT		01/04-11/11	Ch No: >72172468; 75189052;78104400;7G		DAN510	14	105	
1.9 CDTI 8V	Diesel	88	Z 19 DT		01/04-11/11	Ch No: >72172468; 75189052;78104400;7G		DAN509	14	130	
1.9 CDTI 8V	Diesel	88	Z 19 DT		01/04-11/11	MY: >2007		DAN506	14	120	
ASTRA VI (J) (09-15)											
1.6 CDTI	Diesel	81/100	B 16 DTH;B 16 DTL		11/13-10/15	VA;-/+ SS		DAN1331	14	140	
1.6 SIDI	Petrol	147	A 16 SHT;B 16 SHT		09/13-10/15	VA;-/+ SS		DAN1331	14	140	
ASTRA VII (K) (15-)											
1.6 CDTI	Diesel	70/81/ 100/118	B 16 DTE;B 16 DTH; B 16 DTR;B 16 DTU; D 16 DTH;D 16 DTI		07/15-	-/+ SS		DAN1331	14	140	
1.6 Turbo	Petrol	147	B 16 SHT		11/15-	-/+ SS		DAN1331	14	140	
CALIBRA (90-97)											
2.0 i	Petrol	85	C 20 NE		06/90-07/97	Ch No: P1000001; P9000001>		DAN1342	14	100	
2.0 i 16V	Petrol	100	X 20 XEV		02/94-07/97			DAN1342	14	100	
2.0 i 16V	Petrol	110	C 20 XE		06/90-02/94	Ch No: P1000001; P9000001>		DAN1342	14	100	
2.0 i 16V 4x4	Petrol	100	X 20 XEV		02/94-07/97			DAN1342	14	100	
2.0 i 16V 4x4	Petrol	110	C 20 XE		06/90-02/94	Ch No: P1000001; P9000001>		DAN1342	14	100	
2.0 i 4x4	Petrol	85	C 20 NE		06/90-07/97	Ch No: P1000001; P9000001>		DAN1342	14	100	
2.0 i Turbo 4x4	Petrol	150	C 20 LET		03/92-07/97	Ch No: P1000001; P9000001>		DAN1342	14	100	
CASCADA (13-)											
1.6	Petrol	125/147	A 16 SHT;A 16 XHT; B 16 SHL;B 16 SHT		02/13-	VA;-/+ SS		DAN1331	14	140	
CAVALIER III (88-95)											
1.6	Petrol	60	16 SV		09/92-05/93	+ PS		DAN1342	14	100	
1.6 i	Petrol	52/55	C 16 NZ;E 16 NZ; X 16 SZ		09/92-11/95	+ PS		DAN1342	14	100	
1.6 i	Petrol	52/55	C 16 NZ;E 16 NZ; X 16 SZ		09/94-11/95	- PS		DAN1343	14	70	
1.8 i Cat	Petrol	66	18 SV;C 18 NZ		03/90-11/95	+ PS		DAN1342	14	100	
2.0 i 16V	Petrol	100/110	C 20 XE;X 20 XEV		09/88-11/95	+ PS		DAN1342	14	100	
2.0 i Cat	Petrol	85	20 NE;C 20 NE		09/88-11/95	+ PS		DAN1342	14	100	
2.0 i Turbo 4x4	Petrol	150	C 20 LET		09/92-06/94	+ PS		DAN1342	14	100	
2.0 SRi 16V	Petrol	100	X 20 XEV		09/92-08/95	+ PS		DAN1342	14	100	
COMBO I (B) (94-01)											
1.4	Petrol	44	C 14 NZ;X 14 SZ		07/94-10/01	-/+ AC;+ PS		DAN1342	14	100	
1.4	Petrol	44	C 14 NZ;X 14 SZ		09/94-10/01	- PS		DAN1343	14	70	
COMBO II (C) (01-12)											
1.3 CDTI	Diesel	51/55	Y 13 DT;Z 13 DT; Z 13 DTJ		09/04-02/12			DAN1032	14	70	
1.3 CDTI	Diesel	51/55	Y 13 DT;Z 13 DT; Z 13 DTJ		09/04-02/12			DAN1033	14	105	
1.3 CDTI	Diesel	51/55	Y 13 DT;Z 13 DT; Z 13 DTJ		09/04-02/12			DAN1034	14	120	

									
VAUXHALL continued									
COMBO II (C) (01-12) continued									
1.4	Petrol	66	Z 14 XEP		10/04-09/10	2 pin plug	DAN1055	14	70
1.4	Petrol	66	Z 14 XEP		10/04-09/10	Ch No: 73-;74->; 2 pin plug	DAN1340	14	100
1.4 16V	Petrol	66	Z 14 XE		10/01-05/07		DAN1341	14	100
1.4 i 16V	Petrol	66	Z 14 XEP		01/04-11/11	2 pin plug	DAN1055	14	70
1.4 i 16V	Petrol	66	Z 14 XEP		01/04-11/11	Ch No: 73-;74->; 2 pin plug	DAN1340	14	100
1.6	Petrol	62/64	Z 16 SE		09/01-11/11		DAN1341	14	100
CORSA I (B) (93-00)									
1.2 i	Petrol	33	C 12 NZ;X 12 SZ		09/94-09/00	- PS	DAN1343	14	70
1.2 i	Petrol	33	C 12 NZ;X 12 SZ		09/94-09/00	-/+ AC;+ PS	DAN1342	14	100
1.4 i	Petrol	44	C 14 NZ;X 14 SZ		03/93-09/00	-/+ AC;+ PS	DAN1342	14	100
1.4 i	Petrol	44	C 14 NZ;X 14 SZ		09/94-09/00	- PS	DAN1343	14	70
1.4 i 16V	Petrol	66	X 14 XE		09/94-09/00		DAN1342	14	100
1.4 i S	Petrol	60	C 14 SE		03/93-09/00	-/+ AC;+ PS	DAN1342	14	100
1.4 i S	Petrol	60	C 14 SE		09/94-09/00	- PS	DAN1343	14	70
1.6 GSI 16V	Petrol	80	C 16 XE		03/93-09/00		DAN1342	14	100
1.6 i 16V	Petrol	78	X 16 XE		09/94-09/00		DAN1342	14	100
CORSA II (C) (00-06)									
1.0 12V	Petrol	44	Z 10 XE		09/00-10/03	Ch No: 23000001; 24000001;26000001>; 2 pin plug	DAN1055	14	70
1.0 12V	Petrol	44	Z 10 XEP		11/03-10/06	2 pin plug	DAN1055	14	70
1.2 16V	Petrol	55	Z 12 XE		09/00-10/06	Ch No: 23000001; 24000001;26000001>; 2 pin plug	DAN1055	14	70
1.2 16V DualFuel	Petrol/ Liquified Petroleum Gas (LPG)	55	Z 12 XE		08/01-10/06	Ch No: 23000001; 24000001;26000001>; 2 pin plug	DAN1055	14	70
1.2 Twinport	Petrol	59	Z 12 XEP		07/04-10/06	2 pin plug	DAN1055	14	70
1.3 CDTI	Diesel	52	Y 13 DT;Z 13 DT		10/03-04/07		DAN1032	14	70
1.3 CDTI	Diesel	52	Y 13 DT;Z 13 DT		10/03-04/07		DAN1033	14	105
1.3 CDTI	Diesel	52	Y 13 DT;Z 13 DT		10/03-04/07		DAN1034	14	120
1.4	Petrol	66	Z 14 XEP		11/03-06/06	2 pin plug	DAN1055	14	70
1.4	Petrol	66	Z 14 XEP		11/03-06/06	Ch No: 73-;74->; 2 pin plug	DAN1340	14	100
1.4 16V	Petrol	66	Z 14 XE		09/00-10/06		DAN1341	14	100
1.4 Twinport	Petrol	66	Z 14 XEP		06/03-10/06	2 pin plug	DAN1055	14	70
1.4 Twinport	Petrol	66	Z 14 XEP		06/03-10/06	Ch No: 73-;74->; 2 pin plug	DAN1340	14	100
1.8 16V	Petrol	92	Z 18 XE		08/00-09/06		DAN1341	14	100
CORSA III (D) (06-)									
1.0	Petrol	44	Z 10 XEP		08/06-08/14		DAN1340	14	100
1.0	Petrol	44	Z 10 XEP		08/06-08/14	Ch No: >A4999999; A6999999	DAN1055	14	70
1.0 i 12V	Petrol	48	A 10 XEP		01/10-08/14		DAN1340	14	100
1.0 i 12V	Petrol	48	A 10 XEP		01/10-08/14	Ch No: >A4999999; A6999999	DAN1055	14	70
1.2	Petrol	51/59	A 12 XEL;Z 12 XEP		08/06-		DAN1340	14	100
1.2	Petrol	51/59	A 12 XEL;Z 12 XEP		08/06-	Ch No: >A4999999; A6999999	DAN1055	14	70
1.2 i 16V	Petrol	63	A 12 XER		12/09-08/14		DAN1340	14	100
1.2 i 16V	Petrol	63	A 12 XER		12/09-08/14	Ch No: >A4999999; A6999999	DAN1055	14	70
1.2 LPG	Petrol/ Liquified Petroleum Gas (LPG)	59	Z 12 XEP		09/09-08/14	Ch No: >A4999999; A6999999	DAN1055	14	70
1.2 LPG	Petrol/ Liquified Petroleum Gas (LPG)	59/63	A 12 XER;Z 12 XEP		09/09-08/14		DAN1340	14	100
1.3 CDTI	Diesel	55/66/70	A 13 DTC;A 13 DTE; A 13 DTR;Z 13 DTE; Z 13 DTH;Z 13 DTJ		07/06-		DAN583	14	70
1.3 CDTI	Diesel	55/66/70	A 13 DTC;A 13 DTE; A 13 DTR;Z 13 DTE; Z 13 DTH;Z 13 DTJ		07/06-		DAN584	14	105

									
VAUXHALL continued									
CORSA III (D) (06-) continued									
1.3 CDTI	Diesel	55/66/70	A 13 DTC;A 13 DTE; A 13 DTR;Z 13 DTE; Z 13 DTH;Z 13 DTJ		07/06-		DAN585	14	120
1.4	Petrol	66	Z 14 XEP		08/06-08/14		DAN1340	14	100
1.4	Petrol	66	Z 14 XEP		08/06-08/14	Ch No: >A4999999; A6999999	DAN1055	14	70
1.4 LPG	Petrol/ Liquified Petrol eum Gas (LPG)	66	Z 14 XEP		07/06-08/14		DAN1340	14	100
1.4 LPG	Petrol/ Liquified Petrol eum Gas (LPG)	66	Z 14 XEP		07/06-08/14	Ch No: >A4999999; A6999999	DAN1055	14	70
CORSA IV (E) (14-)									
1.2	Petrol	51	B 12 XEL		08/14-	-/+ SS	DAN1322	14	100
1.2	Petrol	51	B 12 XEL		08/14-	-/+ SS	DAN1334	14	140
1.4	Petrol	55/66/ 74/110	B 14 NEH;B 14 NEJ; B 14 XEJ;B 14 XEL; D 14 NEJ;D 14 XEL		08/14-	-/+ SS	DAN1322	14	100
1.4	Petrol	55/66/ 74/110	B 14 NEH;B 14 NEJ; B 14 XEJ;B 14 XEL; D 14 NEJ;D 14 XEL		08/14-	-/+ SS	DAN1334	14	140
FRONTERA I (A) (91-98)									
2.0	Petrol	85	X 20 SE		04/95-08/98	- AC	DAN1342	14	100
2.0 i	Petrol	85	X 20 SE		04/95-10/98	- AC	DAN1342	14	100
2.2 i	Petrol	100	X 22 XE		03/95-10/98	- AC	DAN1342	14	100
FRONTERA II (B) (98-04)									
2.2 i	Petrol	100	X 22 SE;Y 22 SE		10/98-10/04		DAN1342	14	100
INSIGNIA I (A) (08-17)									
1.6 CDTI	Diesel	100	B 16 DTH		07/15-05/17	VA;-/+ SS	DAN1331	14	140
1.6 Turbo	Petrol	125	A 16 XHT;B 16 SHL		07/13-05/17	VA;-/+ SS	DAN1331	14	140
INSIGNIA II (B) (17-)									
1.6 D	Diesel	81/100	B 16 DTE;B 16 DTH; D 16 DTE;D 16 DTH; D 16 DTN		03/17-	-/+ SS;- HWS	DAN1331	14	140
MERIVA I (A) (03-10)									
1.3 CDTI	Diesel	55	Z 13 DTJ		01/03-10/09		DAN1032	14	70
1.3 CDTI	Diesel	55	Z 13 DTJ		01/03-10/09		DAN1033	14	105
1.3 CDTI	Diesel	55	Z 13 DTJ		01/03-10/09		DAN1034	14	120
1.4 16V Twinport	Petrol	66	Z 14 XEP		01/03-06/10	Ch No: 74000001>; 2 pin plug	DAN1055	14	70
1.4 16V Twinport	Petrol	66	Z 14 XEP		01/03-06/10	Ch No: 74000001>; 2 pin plug	DAN1340	14	100
1.6 i	Petrol	64	Z 16 SE		01/03-06/10		DAN1341	14	100
1.6 i 16V	Petrol	74	Z 16 XE		01/03-09/05		DAN1341	14	100
1.8 i 16V	Petrol	92	Z 18 XE		05/03-06/10		DAN1341	14	100
MERIVA II (B) (10-)									
1.3 CDTI	Diesel	55/70	A 13 DTC;A 13 DTE		06/10-		DAN583	14	70
1.3 CDTI	Diesel	55/70	A 13 DTC;A 13 DTE		06/10-		DAN584	14	105
1.3 CDTI	Diesel	55/70	A 13 DTC;A 13 DTE		06/10-		DAN585	14	120
1.6 CDTI	Diesel	70/81/ 100	B 16 DTC;B 16 DTE; B 16 DTH;B 16 DTL; B 16 DTN		08/13-	VA;-/+ SS	DAN1331	14	140
MONTEREY II (98-99)									
3.5 V6 24V	Petrol	158	6 VE1		07/98-08/99		DAN1488	14	90
OMEGA (B) (94-03)									
2.0	Petrol	85	20 SE;X 20 SE		03/94-09/99		DAN1342	14	100
2.0 16V	Petrol	100	X 20 XEV		03/94-07/01		DAN1342	14	100
2.2 16V	Petrol	106	Y 22 XE;Z 22 XE		01/94-06/03		DAN1342	14	100
SIGNUM (02-08)									
1.8	Petrol	90	Z 18 XE		06/03-07/05		DAN1341	14	100
1.9 CDTI	Diesel	88	Z 19 DT		04/04-03/08	Ch No: >71111927	DAN510	14	105
1.9 CDTI	Diesel	88	Z 19 DT		04/04-03/08	Ch No: >71111927	DAN506	14	120
1.9 CDTI	Diesel	88	Z 19 DT		04/04-03/08	Ch No: >71111927	DAN509	14	130
1.9 CDTI 16V	Diesel	110	Z 19 DTH		04/04-03/08	Ch No: >71111927	DAN510	14	105
1.9 CDTI 16V	Diesel	110	Z 19 DTH		04/04-03/08	Ch No: >71111927	DAN506	14	120
1.9 CDTI 16V	Diesel	110	Z 19 DTH		04/04-03/08	Ch No: >71111927	DAN509	14	130
SPEEDSTER (VX220) (00-06)									
2.0 i Turbo	Petrol	147	Z 20 LET		03/01-07/05		DAN1341	14	100

									
VAUXHALL continued									
TIGRA (94-00)									
1.4 16V	Petrol	66	X 14 XE		07/94-12/00		DAN1342	14	100
1.6 16V	Petrol	78	X 16 XE		07/94-12/00		DAN1342	14	100
TIGRA TwinTop (04-09)									
1.3 CDTI	Diesel	51	Z 13 DT		06/04-08/09		DAN1032	14	70
1.3 CDTI	Diesel	51	Z 13 DT		06/04-08/09		DAN1033	14	105
1.3 CDTI	Diesel	51	Z 13 DT		06/04-08/09		DAN1034	14	120
1.4	Petrol	66	Z 14 XEP		06/04-08/09	2 pin plug	DAN1055	14	70
1.4	Petrol	66	Z 14 XEP		06/04-08/09	2 pin plug	DAN1340	14	100
1.8	Petrol	92	Z 18 XE		06/04-08/09		DAN1341	14	100
VECTRA I (B) (95-03)									
1.6 i	Petrol	55	X 16 SZR		08/95-10/01		DAN1342	14	100
1.6 i 16V	Petrol	74	X 16 XEL; Y 16 XE; Z 16 XE		08/95-10/01		DAN1342	14	100
1.8 i 16V	Petrol	85/92	X 18 XE; X 18 XE1; Z 18 XE		10/95-07/03		DAN1342	14	100
2.0 i 16V	Petrol	100	X 20 XEV		10/95-01/01		DAN1342	14	100
VECTRA II (C) (00-08)									
1.8 16V	Petrol	90	Z 18 XE		04/02-07/08		DAN1341	14	100
1.8 16V Dualfuel	Petrol/ Liquified Petroleum Gas (LPG)	90	Z 18 XE		04/02-07/08		DAN1341	14	100
1.9 CDTI	Diesel	88	Z 19 DT		04/02-09/08	Ch No: >71111927; 48999999	DAN510	14	105
1.9 CDTI	Diesel	88	Z 19 DT		04/02-09/08	Ch No: >71111927; 48999999	DAN506	14	120
1.9 CDTI	Diesel	88	Z 19 DT		04/02-09/08	Ch No: >71111927; 48999999	DAN509	14	130
1.9 CDTI 16V	Diesel	110	Z 19 DTH		04/04-05/09	Ch No: >71111927; 48999999	DAN510	14	105
1.9 CDTI 16V	Diesel	110	Z 19 DTH		04/04-05/09	Ch No: >71111927; 48999999	DAN506	14	120
1.9 CDTI 16V	Diesel	110	Z 19 DTH		04/04-05/09	Ch No: >71111927; 48999999	DAN509	14	130
ZAFIRA I (A) (98-05)									
1.6 16V	Petrol	74	X 16 XEL; Z 16 XE		04/99-08/05		DAN1341	14	100
1.6 CNG	Petrol/ Compressed Natural Gas (CNG)	71	Z 16 YNG		09/01-06/05		DAN1341	14	100
1.6 Dualfuel	Petrol/ Liquified Petroleum Gas (LPG)	74	X 16 XEL		11/98-08/05		DAN1341	14	100
1.8 16V	Petrol	85/92	X 18 XE1; Z 18 XE		05/99-08/05		DAN1341	14	100
1.8 Dualfuel	Petrol/ Liquified Petroleum Gas (LPG)	92	Z 18 XE		09/00-08/05		DAN1341	14	100
2.0	Petrol	147	Z 20 LET		06/02-06/05		DAN1341	14	100
2.0 GSI Turbo	Petrol	141	Z 20 LET		09/01-06/05		DAN1341	14	100
ZAFIRA II (B) (05-14)									
1.9 CDTI	Diesel	88/110	Z 19 DT; Z 19 DTH		07/05-11/14	+ MY2007;- POC: WFJ	DAN510	14	105
1.9 CDTI	Diesel	88/110	Z 19 DT; Z 19 DTH		07/05-11/14	+ MY2007;- POC: WFJ	DAN506	14	120
1.9 CDTI	Diesel	88/110	Z 19 DT; Z 19 DTH		07/05-11/14	+ MY2007;- POC: WFJ	DAN509	14	130
1.9 CDTI	Diesel	88/110	Z 19 DT; Z 19 DTH		07/05-11/14	MY: >2007	DAN510	14	105
1.9 CDTI	Diesel	88/110	Z 19 DT; Z 19 DTH		07/05-11/14	MY: >2007	DAN506	14	120
1.9 CDTI	Diesel	88/110	Z 19 DT; Z 19 DTH		07/05-11/14	MY: >2007	DAN509	14	130
ZAFIRA III (C) (11-18)									
1.6 CDTI	Diesel	100	B 16 DTH		03/13-08/18	VA; -/+ SS	DAN1331	14	140
VOLVO									
C30 (06-12)									
1.6	Petrol	74	B 4164 S3		10/06-12/12		DAN1041	14	120
1.6 D	Diesel	80	D 4164 T		10/06-07/11	Ch No: >196529	DAN1119	14	120
1.6 D	Diesel	80	D 4164 T		10/06-07/11	Ch No: >196529	DAN930	14	150
1.6 D	Diesel	80	D 4164 T		10/06-07/11	Ch No: 196530>235568	DAN1118	14	150

										A
VOLVO continued										
C30 (06-12) continued										
1.8	Petrol	92	B 4184 S11			10/06-07/10		DAN1016	14	120
1.8	Petrol	92	B 4184 S11			10/06-07/10		DAN934	14	150
1.8 FlexFuel	Flexfuel	92	B 4184 S8			01/07-07/10		DAN1016	14	120
1.8 FlexFuel	Flexfuel	92	B 4184 S8			01/07-07/10		DAN934	14	150
2.0	Petrol	107	B 4204 S3			10/06-12/12		DAN1016	14	120
2.0	Petrol	107	B 4204 S3			10/06-12/12		DAN934	14	150
2.0 D	Diesel	100	D 4204 T			10/06-09/10		DAN1119	14	120
2.0 D	Diesel	100	D 4204 T			10/06-09/10		DAN930	14	150
2.0 FlexFuel	Flexfuel	107	B 4204 S4			01/10-12/12		DAN1016	14	120
2.0 FlexFuel	Flexfuel	107	B 4204 S4			01/10-12/12		DAN934	14	150
C70 II (06-13)										
2.0 D	Diesel	100	D 4204 T			01/08-10/09	Ch No: >112000	DAN1119	14	120
2.0 D	Diesel	100	D 4204 T			01/08-10/09	Ch No: >112000	DAN930	14	150
2.4	Petrol	103	B 5244 S5			03/06-07/06	Ch No: >9999	DAN1059	14	150
2.4 i	Petrol	125	B 5244 S4			03/06-07/06	Ch No: >9999	DAN1059	14	150
2.5 T5	Petrol	162	B 5254 T3			03/06-07/06	Ch No: >9999	DAN1059	14	150
2.5 T5	Petrol	169	B 5254 T7			03/07-06/13		DAN1059	14	150
S40 II (04-12)										
1.6	Petrol	74	B 4164 S3			01/05-12/12		DAN1041	14	120
1.6	Petrol	74	B 4164 S3			01/05-12/12	TRN: MTX75	DAN934	14	150
1.6 D	Diesel	81	D 4164 T			01/05-12/12	Ch No: >503828	DAN1119	14	120
1.6 D	Diesel	81	D 4164 T			01/05-12/12	Ch No: >503828	DAN930	14	150
1.6 D	Diesel	81	D 4164 T			01/05-12/12	Ch No: 503829>540624	DAN1118	14	150
1.8	Petrol	92	B 4184 S11			04/04-12/10		DAN1016	14	120
1.8	Petrol	92	B 4184 S11			04/04-12/10		DAN934	14	150
1.8 FlexFuel	Flexfuel	92	B 4184 S8			01/06-07/10		DAN1016	14	120
1.8 FlexFuel	Flexfuel	92	B 4184 S8			01/06-07/10		DAN934	14	150
2.0	Petrol	107	B 4204 S3			10/06-12/12		DAN1016	14	120
2.0	Petrol	107	B 4204 S3			10/06-12/12		DAN934	14	150
2.0 CDI	Diesel	98	D 4204 T2	MTM		07/05-12/06		DAN930	14	150
2.0 D	Diesel	100	D 4204 T			01/04-07/10		DAN1118	14	150
2.0 D4	Diesel	96	D 4204 T2			07/05-12/06		DAN930	14	150
2.0 F	Flexfuel	107	B 4204 S4			10/09-12/12		DAN1016	14	120
2.0 F	Flexfuel	107	B 4204 S4			10/09-12/12		DAN934	14	150
2.4	Petrol	103/125	B 5244 S4;B 5244 S5			01/04-07/06	Ch No: 45204>250052	DAN1059	14	150
2.4 D5	Diesel	132	D 5244 T13;D 5244 T8			03/06-07/06		DAN1059	14	150
2.5 T5	Petrol	162	B 5254 T3			01/04-07/06	Ch No: 45204>250052	DAN1059	14	150
2.5 T5 AWD	Petrol	162	B 5254 T3			04/04-07/06	Ch No: 45204>250052	DAN1059	14	150
V50 (04-12)										
1.6	Petrol	74	B 4164 S3			01/05-12/12		DAN1041	14	120
1.6 D	Diesel	80	D 4164 T			01/05-07/10	Ch No: >554734	DAN1119	14	120
1.6 D	Diesel	80	D 4164 T			01/05-07/10	Ch No: >554734	DAN930	14	150
1.6 D	Diesel	80	D 4164 T			01/05-07/10	Ch No: 554735>614294	DAN1118	14	150
1.6 D	Diesel	80	D 4164 T			03/05-07/10		DAN930	14	150
1.8	Petrol	92	B 4184 S11			04/04-07/10		DAN1016	14	120
1.8	Petrol	92	B 4184 S11			04/04-07/10		DAN934	14	150
1.8 BiFuel	Petrol/ Liquified Petroleum Gas (LPG)	93	B 4184 S8			01/09-07/10		DAN1016	14	120
1.8 FlexFuel	Flexfuel	92	B 4184 S8			05/06-07/10		DAN1016	14	120
1.8 FlexFuel	Flexfuel	92	B 4184 S8			05/06-07/10		DAN934	14	150
2.0	Petrol	107	B 4204 S3			06/09-12/12		DAN1016	14	120
2.0	Petrol	107	B 4204 S3			06/09-12/12		DAN934	14	150
2.0 CDI	Diesel	98	D 4204 T2			04/04-12/06		DAN930	14	150
2.0 D	Diesel	100	D 4204 T			04/04-07/10		DAN1119	14	120
2.0 D	Diesel	100	D 4204 T			04/04-07/10		DAN930	14	150
2.0 D4 I-4	Diesel	96	D 4204 T2			07/05-12/06		DAN930	14	150
2.0 FlexFuel	Flexfuel	107	B 4204 S4			01/10-12/12		DAN1016	14	120
2.0 FlexFuel	Flexfuel	107	B 4204 S4			01/10-12/12		DAN934	14	150
2.4	Petrol	103/125	B 5244 S4;B 5244 S5			04/04-07/06	Ch No: 40123>270049	DAN1059	14	150
2.4 D5	Diesel	132	D 5244 T13;D 5244 T8			03/06-07/06		DAN1059	14	150
2.5 T5	Petrol	162	B 5254 T3			04/04-07/06	Ch No: 40123>270049	DAN1059	14	150
2.5 T5 AWD	Petrol	162	B 5254 T3			04/04-07/06	Ch No: 40123>270049	DAN1059	14	150
VW										
BEETLE (5C) (11-19)										
1.6 TDI	Diesel	77	CAYC			10/11-06/16	BO;VA;+ SS	DAN1328	14	140

									
VW continued									
CADDY III (2K, 2C) (04-15)									
1.6 TDI	Diesel	55/75	CAYD;CAYE		08/10-05/15	BO;VA;+ SS	DAN1328	14	140
2.0 TDI	Diesel	62/81/ 103/125	CFHC;CFHE;CFJA; CLCA;CLCB		08/10-05/15	BO;VA;+ SS	DAN1328	14	140
2.0 TDI 4motion	Diesel	62/81/ 103	CFHC;CFHE;CFHF		08/10-05/15	BO;VA;+ SS	DAN1328	14	140
CADDY IV (SA) (15-)									
1.6 TDI	Diesel	55/75	CAYD;CAYE		05/15-	BO;VA;+ SS	DAN1328	14	140
2.0 TDI	Diesel	103	CFHC;CLCB		05/15-	BO;VA;+ SS	DAN1328	14	140
2.0 TDI 4motion	Diesel	81/103	CFHC;CFHF;CLCA		05/15-	BO;VA;+ SS	DAN1328	14	140
EOS (1F) (06-15)									
2.0 TDI	Diesel	100/103	CFFA;CFFB		11/10-08/15	BO;VA;+ SS	DAN1328	14	140
GOLF Plus (5M, 521) (05-14)									
1.6 TDI	Diesel	66/77	CAYB;CAYC		02/09-12/13	BO;VA;+ SS	DAN1328	14	140
GOLF VI (5K, AJ5) (08-14)									
1.6 TDI	Diesel	66/77	CAYB;CAYC		02/09-07/13	BO;VA;+ SS	DAN1328	14	140
1.6 TDI 4motion	Diesel	77	CAYC		07/09-07/13	BO;VA;+ SS	DAN1328	14	140
2.0 TDI	Diesel	100/103/ 125	CBAA;CBAB;CBBB; CFFA;CFFB;CFGB; CJAA		10/08-05/13	BO;VA;+ SS	DAN1328	14	140
2.0 TDI 4motion	Diesel	103	CBAB;CFFB		05/09-11/12	BO;VA;+ SS	DAN1328	14	140
GOLF VI Convertible (517) (11-16)									
1.6 TDI	Diesel	77	CAYC		03/11-05/16	BO;VA;+ SS	DAN1328	14	140
2.0 TDI	Diesel	103	CFHC		11/11-05/16	BO;VA;+ SS	DAN1328	14	140
JETTA IV (162) (10-)									
1.6 TDI	Diesel	77	CAYC		04/10-07/14	BO;VA;+ SS	DAN1328	14	140
POLO (6R, 6C) (09-)									
1.6 TDI	Diesel	55/66/77	CAYA;CAYB;CAYC; CLNA		06/09-05/14	BO;VA;+ SS	DAN1328	14	140
SCIROCCO (137, 138) (08-17)									
2.0 TDI	Diesel	100/103/ 125/130	CFGB;CFGC;CFHB; CFHC		11/10-05/14	BO;VA;+ SS	DAN1328	14	140
SHARAN (7N) (10-)									
2.0 TDI	Diesel	85/100/ 103/125/ 130	CFFA;CFFB;CFFE; CFGB;CFGC;DLUB		05/10-11/15	BO;VA;+ SS	DAN1328	14	140
2.0 TDI 4motion	Diesel	103	CFFB		05/11-11/15	BO;VA;+ SS	DAN1328	14	140
TIGUAN (5N) (07-18)									
2.0 TDI	Diesel	81/103	CBAB;CFFB;CFFD; CUVE		11/09-07/18	BO;VA;+ SS	DAN1328	14	140
2.0 TDI 4motion	Diesel	100/103/ 125/130	CBAA;CBAB;CBBB; CFFA;CFFB;CFGB; CFGC;CLJA		11/09-07/18	BO;VA;+ SS	DAN1328	14	140
TOURAN (1T3) (10-15)									
1.6 TDI	Diesel	66/77	CAYB;CAYC		05/10-05/15	BO;VA	DAN1328	14	140
2.0 TDI	Diesel	81/103/ 125/130	CFHC;CFHF;CFJA; CFJB;CLCA		05/10-05/15	BO;VA	DAN1328	14	140

DENSO Photo Guide



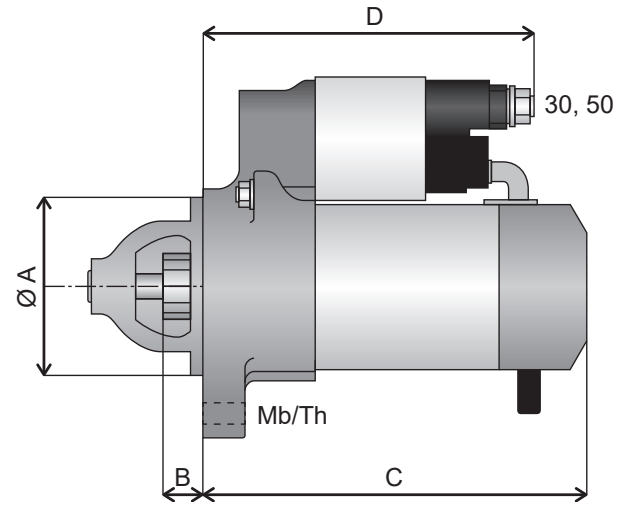
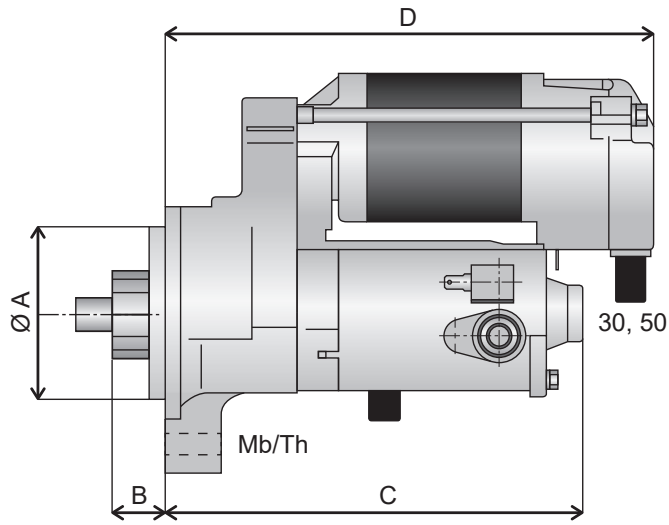
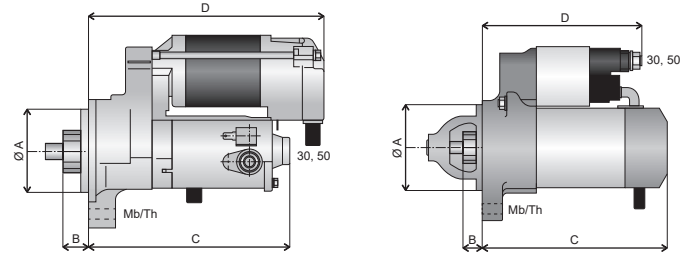

Photo guide Legend Starters

	GB	DE	FR	ES	IT	SE	PL	RU
	Clock Wise Rotation; Number of Teeth	Drehrichtung im Uhrzeigersinn; Anzahl der Zähne	Rotation horaire ; Nombre de dents	Giro a derechas; Número de dientes	Rotazione in senso orario; Numero denti ingranaggio	Rotation medurs; Antal kuggar	Zgodnie z ruchem wskazówek zegara; Liczba zębów	Вращение по часовой стрелке; Количество зубьев
	Anti-Clock Wise Rotation; Number of Teeth	Drehrichtung gegen den Uhrzeigersinn; Anzahl der Zähne	Rotation anti- horaire ; Nombre de dents	Giro a izquierdas; Número de dientes	Rotazione in senso antiorario; Numero denti ingranaggio	Rotation moturs; Antal kuggar	Przeciwnie do ruchu wskazówek zegara; Liczba zębów	Вращение против часовой стрелки; Количество зубьев
30	Terminal 30 (Battery +)	Terminal 30 (Batterie +)	Borne 30 (+ batterie)	Borne 30 (Bateria +)	Terminale 30 (Batteria +)	Anslutning 30 (batteri +)	Terminal 30 (+ z akumulatora)	Клемма 30 (Аккумулятор +)
50	Terminal 50 (Magnetic Switch)	Terminal 50 (Magnetschalter)	Borne 50 (Commutateur magnétique)	Borne 50 (interruptor magnético)	Terminale 50 (Teleruttore)	Anslutning 50 (startrelä)	Rozrusznik (elektromagnes)	Клемма 50 (магнитный выключатель)
Plug	Plug	Stecker	Fiche	Enchufe	Spina	Stift	Zaptonowe	штепсель
Mb	Mounting Bores	Befestigungsbohrung	Alésages de fixation	Taladros de fijación	Fori di montaggio	Fästhål	Liczba otworów do mocowania	Установочные отверстия
Th	Thread Bores	Gewindebohrungen	Alésages filetés	Taladros de fijación roscados	Fori filettati	Gängade hål	Liczba otworów gwintowanych	Диаметр резьбы



DSN577		12V	1.0kW
8	ØA = 64mm	B = 10.6mm	
C = 159mm	D = 140mm	30, 50 = M8, M6	
	Th = 3xM8		

DSN577		12V	1.0kW
8	ØA = 64mm	B = 10.6mm	
C = 159mm	D = 140mm	30, 50 = M8, M6	
	Th = 3xM8		

DSN579		12V	1.4kW
9	ØA = 66mm	B = 9.3mm	
C = 164mm	D = 145mm	30, 50 = M8, M6	
Mb = 2xØ9, 1xØ11			

DSN579		12V	1.4kW
9	ØA = 66mm	B = 9.3mm	
C = 164mm	D = 145mm	30, 50 = M8, M6	
Mb = 2xØ9, 1xØ11			

DSN600		12V	2.0kW
9	ØA = 66mm	B = 21mm	
C = 131mm	D = 187mm	30, 50 = M8, Plug	
Mb = 3xØ11			

DSN600		12V	2.0kW
9	ØA = 66mm	B = 21mm	
C = 131mm	D = 187mm	30, 50 = M8, Plug	
Mb = 3xØ11			

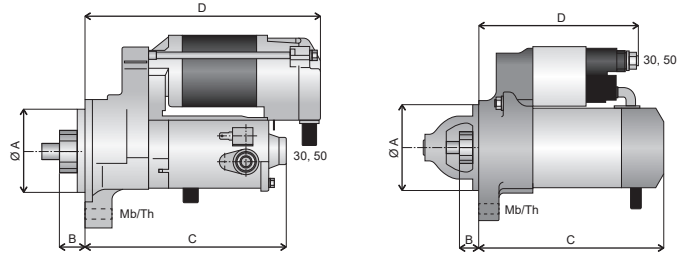

DSN601		12V	2.0kW
9	ØA = 76mm	B = 21mm	
C = 131mm	D = 187mm	30, 50 = M8, Plug	
Mb = 1xØ10, 1xØ11	Th = 1xM10		

DSN601		12V	2.0kW
9	ØA = 76mm	B = 21mm	
C = 131mm	D = 187mm	30, 50 = M8, Plug	
Mb = 1xØ10, 1xØ11	Th = 1xM10		

DSN602		12V	1kW
10	ØA = 75mm	B = 39.8mm	
C = 149mm	D = 117mm	30, 50 = M8, Plug	
Mb = 2xØ13			

DSN602		12V	1kW
10	ØA = 75mm	B = 39.8mm	
C = 149mm	D = 117mm	30, 50 = M8, Plug	
Mb = 2xØ13			

DSN603		12V	2.0kW
15	ØA = 55mm	B = 66mm	
C = 121mm	D = 167mm	30, 50 = M8, Plug	
Mb = 3xØ11			

DSN603		12V	2.0kW
15	ØA = 55mm	B = 66mm	
C = 121mm	D = 167mm	30, 50 = M8, Plug	
Mb = 3xØ11			

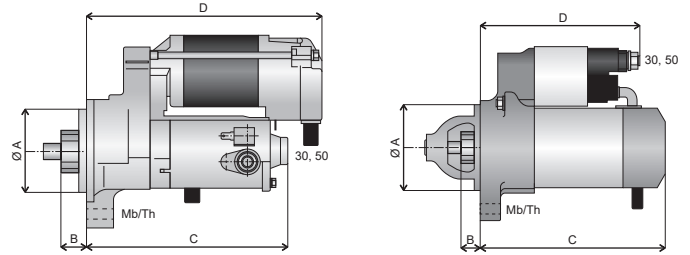

DSN604		12V	2.0kW
11	ØA = 75mm	B = 39mm	
C = 118mm	D = 174mm	30, 50 = M8, Plug	
Mb = 2xØ13.2			

DSN604		12V	2.0kW
11	ØA = 75mm	B = 39mm	
C = 118mm	D = 174mm	30, 50 = M8, Plug	
Mb = 2xØ13.2			

DSN605		12V	1.4kW
9	ØA = 62mm	B = 36mm	
C = 144mm	D = 168mm	30, 50 = M8, M5	
Mb = 2xØ11			

DSN605		12V	1.4kW
9	ØA = 62mm	B = 36mm	
C = 144mm	D = 168mm	30, 50 = M8, M5	
Mb = 2xØ11			

DSN920		12V	1.3kW
9	ØA = 74mm	B = 15mm	
C = 140mm	D = 129mm	30, 50 = M8, Plug	
Mb = 1xØ11	Th = 1xM10		

DSN920		12V	1.3kW
9	ØA = 74mm	B = 15mm	
C = 140mm	D = 129mm	30, 50 = M8, Plug	
Mb = 1xØ11	Th = 1xM10		

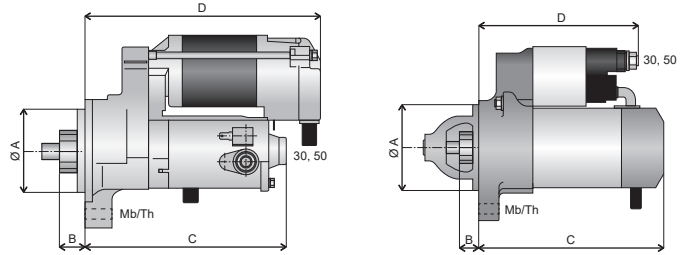

DSN921		12V	1.0kW
9 C = 163mm Mb = 1xØ11	ØA = 74mm D = 140mm Th = 1xM10	B = 15mm 30, 50 = M8, Plug	

DSN921		12V	1.0kW
9 C = 163mm Mb = 1xØ11	ØA = 74mm D = 140mm Th = 1xM10	B = 15mm 30, 50 = M8, Plug	



DSN922		12V	1.2kW
13 C = 121mm Mb = 2xØ11.3	ØA = 55mm D = 134mm	B = 66mm 30, 50 = M8, Plug	



DSN922		12V	1.2kW
13 C = 121mm Mb = 2xØ11.3	ØA = 55mm D = 134mm	B = 66mm 30, 50 = M8, Plug	

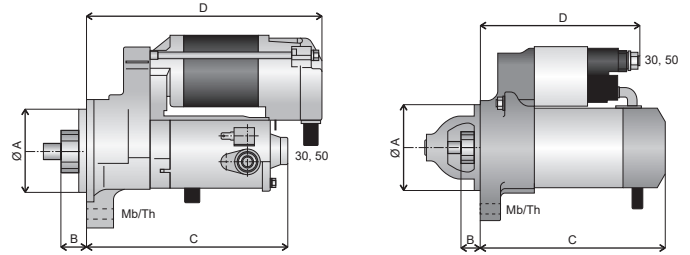

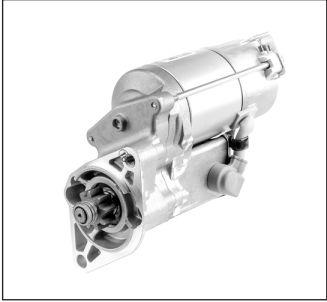
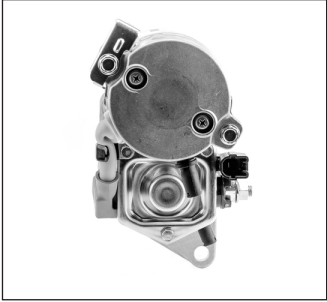
DSN923		12V	1.2kW
13 C = 121mm Mb = 2xØ11.3	ØA = 55mm D = 134mm	B = 66mm 30, 50 = M8, Plug	

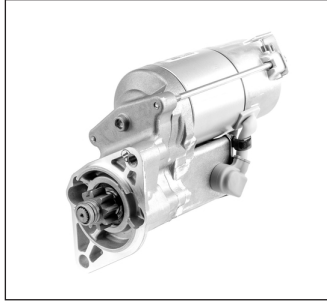
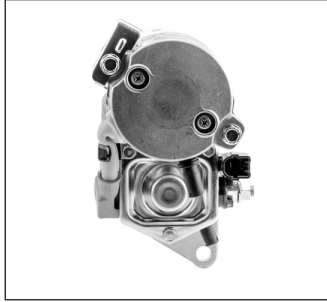

DSN923		12V	1.2kW
13 C = 121mm Mb = 2xØ11.3	ØA = 55mm D = 134mm	B = 66mm 30, 50 = M8, Plug	







DSN926		12V	2.0kW
 			
 9 C = 138mm Mb = 1xØ11	ØA = 74mm D = 194mm Th = 1xM10	B = 14mm 30, 50 = M8, Plug	

DSN926		12V	2.0kW
 			
 9 C = 138mm Mb = 1xØ11	ØA = 74mm D = 194mm Th = 1xM10	B = 14mm 30, 50 = M8, Plug	

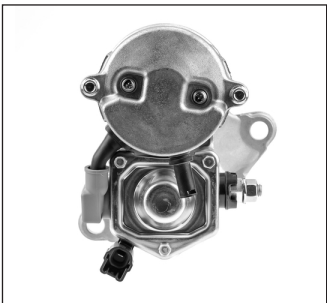

DSN928		12V	2.2kW
 			
 9 C = 179mm Mb = 2xØ11.3	ØA = 74mm D = 219mm Th = 2xM10	B = 3.2mm 30, 50 = M8, Plug	

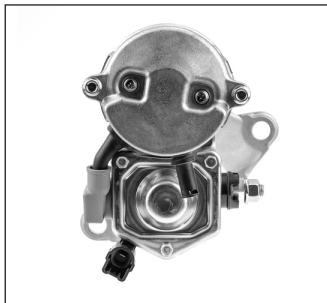

DSN928		12V	2.2kW
 			
 9 C = 179mm Mb = 2xØ11.3	ØA = 74mm D = 219mm Th = 2xM10	B = 3.2mm 30, 50 = M8, Plug	

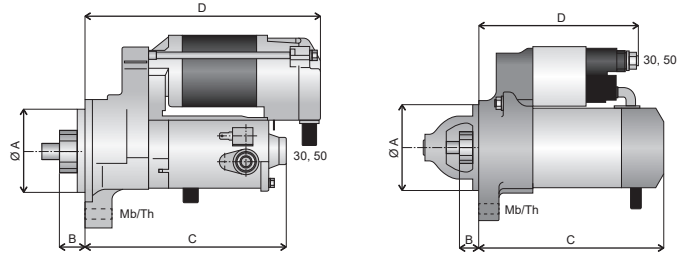

DSN929		12V	1.4kW
 			
 13 C = 121mm Mb = 2xØ11.3	ØA = 55mm D = 145mm	B = 66mm 30, 50 = M8, Plug	



DSN929		12V	1.4kW
 			
 13 C = 121mm Mb = 2xØ11.3	ØA = 55mm D = 145mm	B = 66mm 30, 50 = M8, Plug	







DSN931		12V	1.0kW
			
 9	ØA = 74mm	B = 11.5mm	
C = 166mm	D = 144mm	30, 50 = M8, Plug	
Mb = 1xØ11	Th = 1xM10		

DSN931		12V	1.0kW
			
 9	ØA = 74mm	B = 11.5mm	
C = 166mm	D = 144mm	30, 50 = M8, Plug	
Mb = 1xØ11	Th = 1xM10		

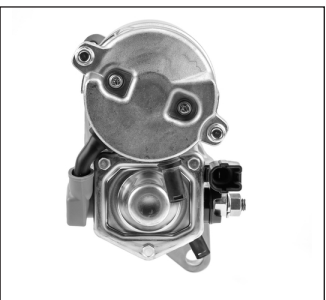

DSN934		12V	1.0kW
			
 9	ØA = 74mm	B = 14mm	
C = 164mm	D = 141mm	30, 50 = M8, Plug	
Mb = 1xØ11	Th = 1xM10		

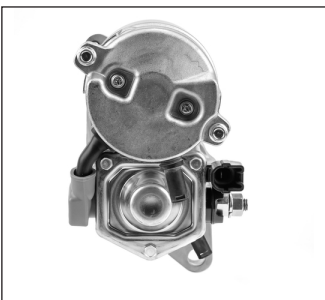

DSN934		12V	1.0kW
			
 9	ØA = 74mm	B = 14mm	
C = 164mm	D = 141mm	30, 50 = M8, Plug	
Mb = 1xØ11	Th = 1xM10		

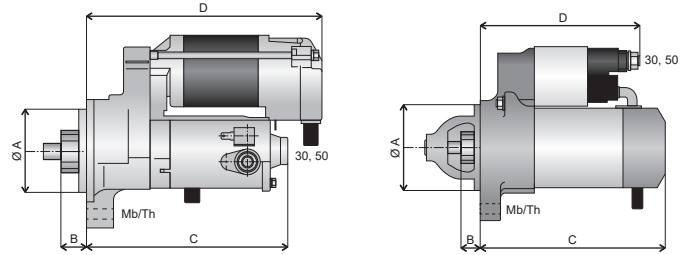

DSN935		12V	1.4kW
			
 9	ØA = 74mm	B = 14mm	
C = 138mm	D = 161mm	30, 50 = M8, Plug	
Mb = 1xØ11	Th = 1xM10		



DSN935		12V	1.4kW
			
 9	ØA = 74mm	B = 14mm	
C = 138mm	D = 161mm	30, 50 = M8, Plug	
Mb = 1xØ11	Th = 1xM10		







DSN936		12V	1.6kW
 			
 10 C = 135mm Mb = 1xØ11	ØA = 74mm D = 130mm Th = 1xM10	B = 14mm 30, 50 = M8, Plug	

DSN936		12V	1.6kW
 			
 10 C = 135mm Mb = 1xØ11	ØA = 74mm D = 130mm Th = 1xM10	B = 14mm 30, 50 = M8, Plug	

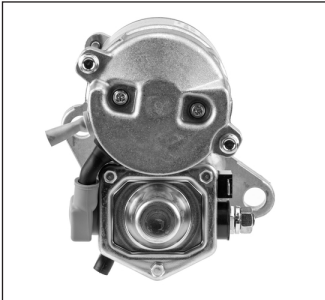
DSN937		12V	2.0kW
 			
 9 C = 138mm Mb = 1xØ11	ØA = 74mm D = 194mm Th = 1xM10	B = 14mm 30, 50 = M8, Plug	

DSN937		12V	2.0kW
 			
 9 C = 138mm Mb = 1xØ11	ØA = 74mm D = 194mm Th = 1xM10	B = 14mm 30, 50 = M8, Plug	

DSN941		12V	1.4kW
 			
 11 C = 121mm Mb = 2xØ13	ØA = 55mm D = 145mm	B = 66mm 30, 50 = M8, Plug	

DSN941		12V	1.4kW
 			
 11 C = 121mm Mb = 2xØ13	ØA = 55mm D = 145mm	B = 66mm 30, 50 = M8, Plug	

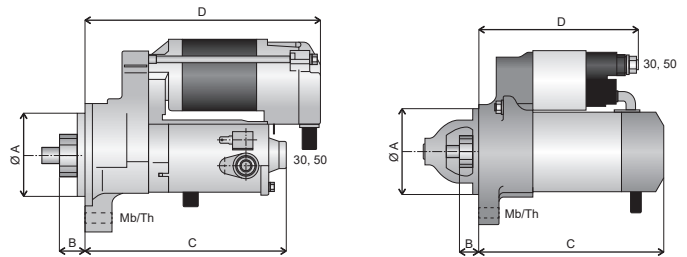

DSN942		12V	2.2kW
21		30, 50 = M8, M5	
Mb = 2xØ9, 2xØ11			

DSN942		12V	2.2kW
21		30, 50 = M8, M5	
Mb = 2xØ9, 2xØ11			



DSN944		12V	2kW
9	ØA = 70mm	B = 25mm	
C = 211mm	D = 166mm	30, 50 = M8, M6	
	Th = 2xM10, 2xM8		



DSN944		12V	2kW
9	ØA = 70mm	B = 25mm	
C = 211mm	D = 166mm	30, 50 = M8, M6	
	Th = 2xM10, 2xM8		

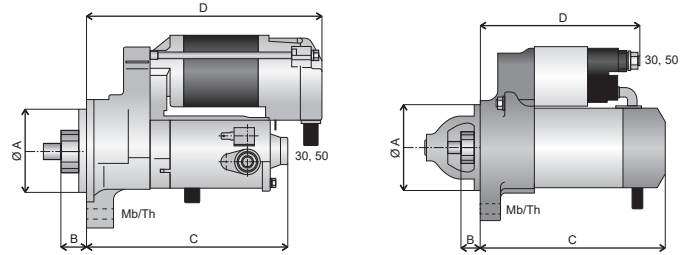

DSN946		12V	2kW
10	ØA = 74mm	B = 13mm	
C = 182mm	D = 135mm	30, 50 = M8, Plug	
Mb = 1xØ11	Th = 1xM10		



DSN946		12V	2kW
10	ØA = 74mm	B = 13mm	
C = 182mm	D = 135mm	30, 50 = M8, Plug	
Mb = 1xØ11	Th = 1xM10		









DSN948		12V	1.3kW
 			
 9 C = 129mm Mb = 1xØ11	ØA = 74mm D = 119mm Th = 1xM10	B = 25.7mm 30, 50 = M8, Plug	

DSN948		12V	1.3kW
 			
 9 C = 129mm Mb = 1xØ11	ØA = 74mm D = 119mm Th = 1xM10	B = 25.7mm 30, 50 = M8, Plug	



DSN949		12V	1.3kW
 			
 9 C = 131mm Mb = 1xØ11	ØA = 74mm D = 120mm Th = 1xM10	B = 24mm 30, 50 = M8, Plug	



DSN949		12V	1.3kW
 			
 9 C = 131mm Mb = 1xØ11	ØA = 74mm D = 120mm Th = 1xM10	B = 24mm 30, 50 = M8, Plug	

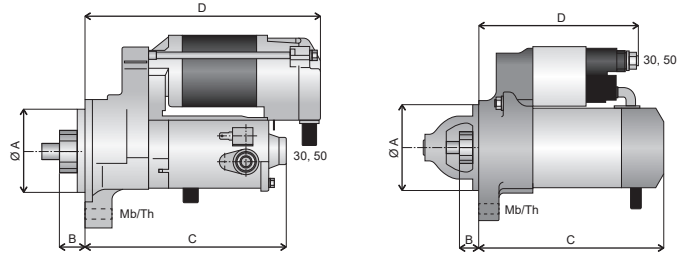

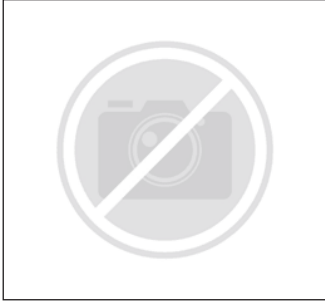
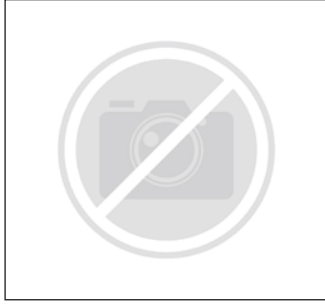
DSN950		12V	2kW
 			
 9 C = 191mm	ØA = 74mm D = 145mm Th = 2xM10	B = 3.2mm 30, 50 = M8, Plug	

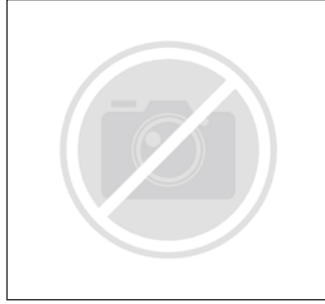
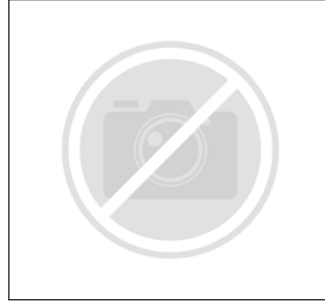

DSN950		12V	2kW
 			
 9 C = 191mm	ØA = 74mm D = 145mm Th = 2xM10	B = 3.2mm 30, 50 = M8, Plug	



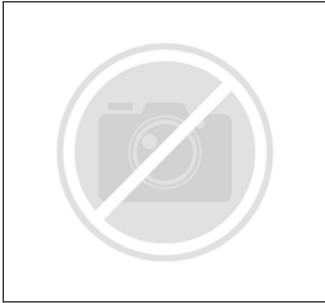
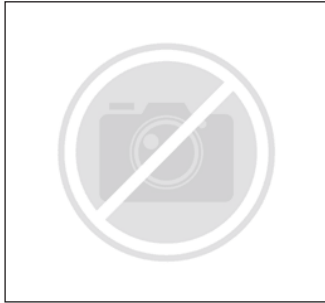

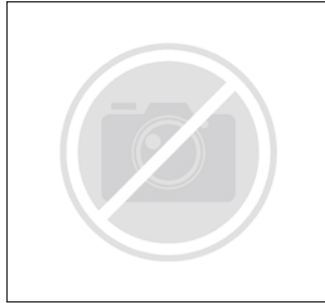
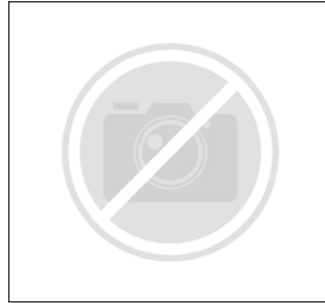

DSN951		12V	1.2kW
 			
 8 C = 146mm Mb = 1xØ10.5	ØA = 70mm D = 118mm Th = 1xM10	B = 11.7mm 30, 50 = M8, Plug	

DSN951		12V	1.2kW
 			
 8 C = 146mm Mb = 1xØ10.5	ØA = 70mm D = 118mm Th = 1xM10	B = 11.7mm 30, 50 = M8, Plug	

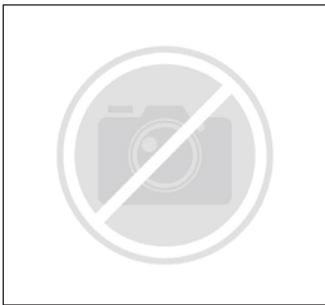
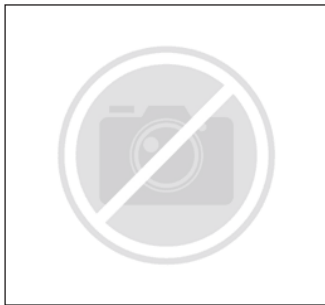
DSN952		12V	1.2kW
 			
 8 C = 137mm Mb = 1xØ10.5	ØA = 82.5mm D = 110mm Th = 1xM10	B = 42.5mm 30, 50 = M8, Plug	

DSN952		12V	1.2kW
 			
 8 C = 137mm Mb = 1xØ10.5	ØA = 82.5mm D = 110mm Th = 1xM10	B = 42.5mm 30, 50 = M8, Plug	

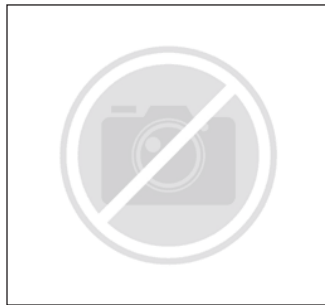
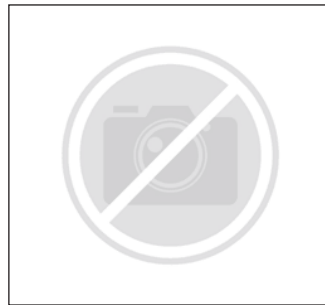
DSN953		12V	2.5kW
 			
 9 C = 213mm Mb = 2xØ11	ØA = 95mm D = 177mm	B = 11mm 30, 50 = M8, Plug	

DSN953		12V	2.5kW
 			
 9 C = 213mm Mb = 2xØ11	ØA = 95mm D = 177mm	B = 11mm 30, 50 = M8, Plug	

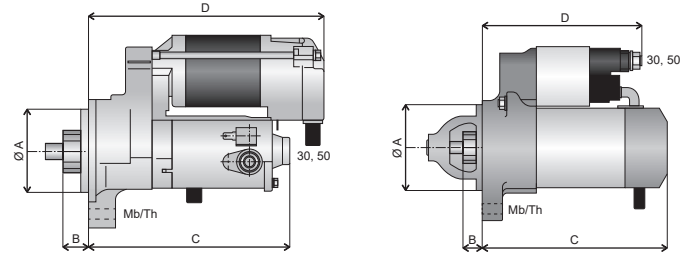

DSN954		12V	1.4kW
13	ØA = 75mm	B = 61mm	
C = 144mm	D = 111mm	30, 50 = M8, Plug	
Mb = 1xØ10.5, 1xØ13	Th = 2xM6		

DSN954		12V	1.4kW
13	ØA = 75mm	B = 61mm	
C = 144mm	D = 111mm	30, 50 = M8, Plug	
Mb = 1xØ10.5, 1xØ13	Th = 2xM6		



DSN955		12V	1kW
10	ØA = 70mm	B = 19.7mm	
C = 136mm	D = 119mm	30, 50 = M8, M5	
Mb = 2xØ13			



DSN955		12V	1kW
10	ØA = 70mm	B = 19.7mm	
C = 136mm	D = 119mm	30, 50 = M8, M5	
Mb = 2xØ13			

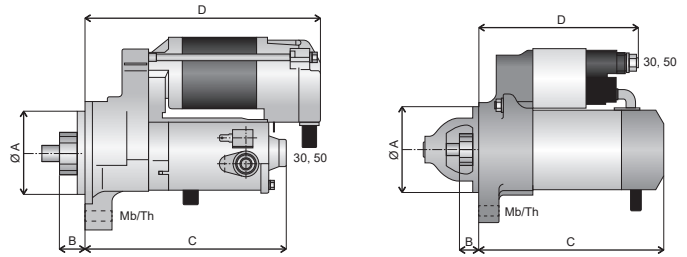

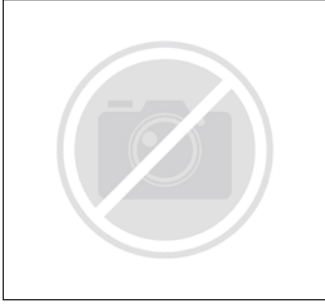
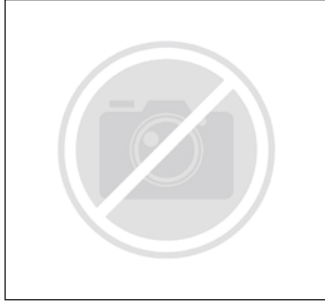
DSN956		12V	2.5kW
9	ØA = 82.5mm	B = 11mm	
C = 200mm	D = 175mm	30, 50 = M8, Plug	
Mb = 2xØ11			

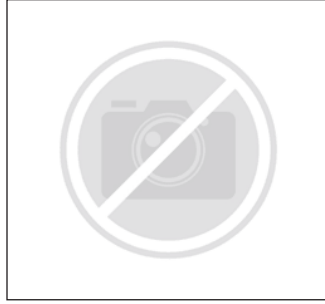
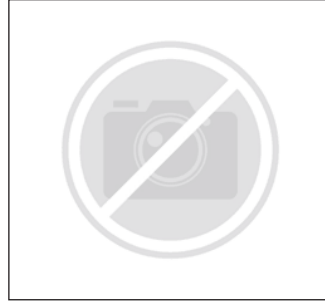

DSN956		12V	2.5kW
9	ØA = 82.5mm	B = 11mm	
C = 200mm	D = 175mm	30, 50 = M8, Plug	
Mb = 2xØ11			



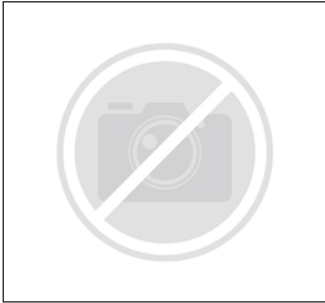
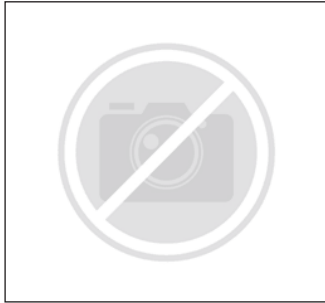

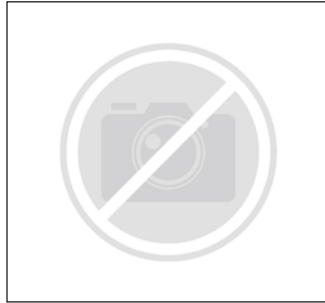
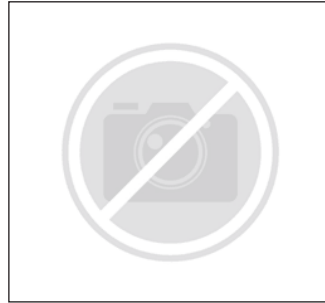

DSN957		12V	1.4kW
 			
 10 Mb = 3			30, 50 = M8, Plug

DSN957		12V	1.4kW
 			
 10 Mb = 3			30, 50 = M8, Plug

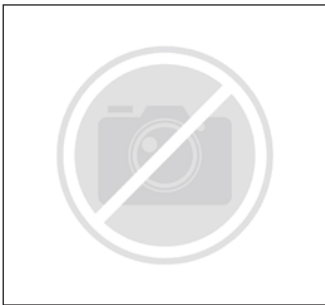
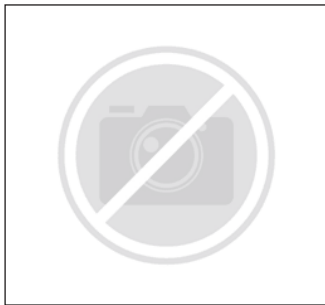

DSN958		12V	2.4kW
 			
 15 Mb = 3			30, 50 = M8, Plug

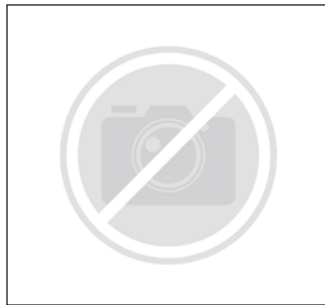
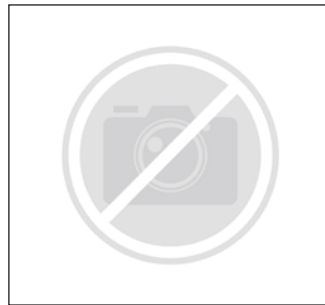

DSN958		12V	2.4kW
 			
 15 Mb = 3			30, 50 = M8, Plug

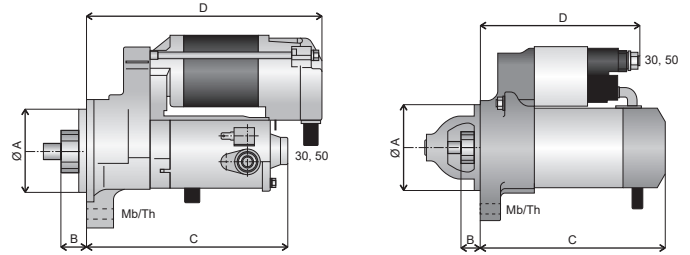

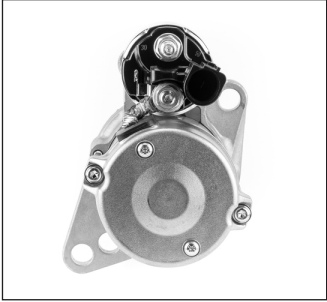
DSN962		12V	2.0kW
 			
 13 C = 153mm Mb = 2xØ12.5	ØA = 79mm D = 143mm	B = 62mm 30, 50 = M8, Plug	

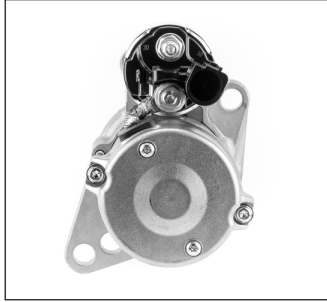

DSN962		12V	2.0kW
 			
 13 C = 153mm Mb = 2xØ12.5	ØA = 79mm D = 143mm	B = 62mm 30, 50 = M8, Plug	



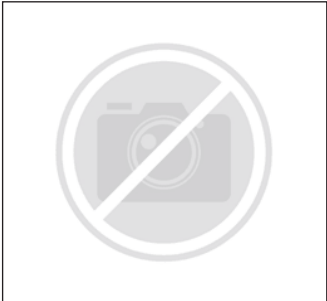
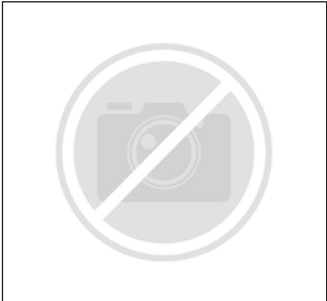

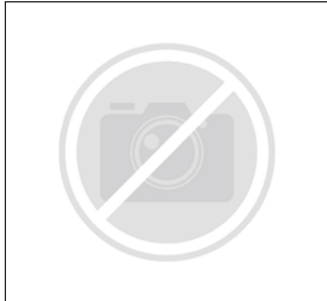
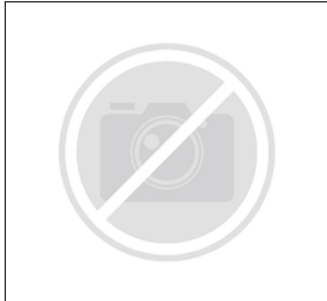

DSN963		12V	2.0kW
 			
 12 C = 162mm Mb = 3xØ12.5	ØA = 76.2mm D = 147mm	B = 53.7mm 30, 50 = M8, Plug	

DSN963		12V	2.0kW
 			
 12 C = 162mm Mb = 3xØ12.5	ØA = 76.2mm D = 147mm	B = 53.7mm 30, 50 = M8, Plug	

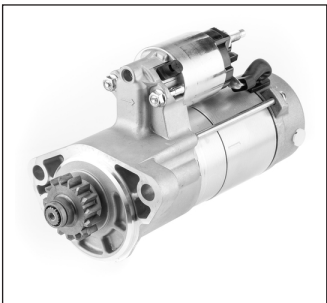
DSN964		12V	2.0kW
 			
 13 C = 158mm Mb = 2xØ12.5	ØA = 79mm D = 148mm	B = 56.8mm 30, 50 = M8, Plug	

DSN964		12V	2.0kW
 			
 13 C = 158mm Mb = 2xØ12.5	ØA = 79mm D = 148mm	B = 56.8mm 30, 50 = M8, Plug	

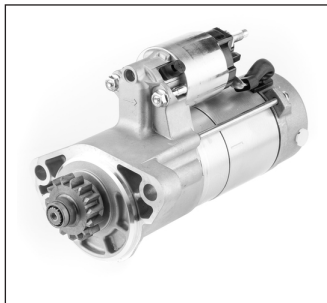
DSN965		12V	2.0kW
 			
 15 C = 209mm Mb = 1xØ10.5, 1xØ11	ØA = 76.2mm D = 164mm	B = 25mm 30, 50 = M8, Plug Th = 1xM10	

DSN965		12V	2.0kW
 			
 15 C = 209mm Mb = 1xØ10.5, 1xØ11	ØA = 76.2mm D = 164mm	B = 25mm 30, 50 = M8, Plug Th = 1xM10	

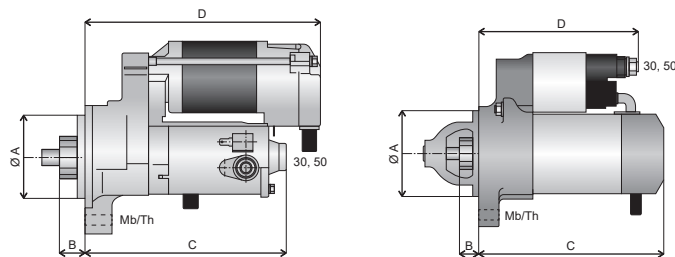

DSN967		12V	1.8kW
12 C = 152mm	ØA = 70mm D = 149mm Th = 2xM10	B = 15.3mm 30, 50 = M8, M6	

DSN967		12V	1.8kW
12 C = 152mm	ØA = 70mm D = 149mm Th = 2xM10	B = 15.3mm 30, 50 = M8, M6	

DSN968		12V	1.8kW
12 C = 141mm	ØA = 82.5mm D = 134mm Th = 2xM10	B = 26.2mm 30, 50 = M8, M6	

DSN968		12V	1.8kW
12 C = 141mm	ØA = 82.5mm D = 134mm Th = 2xM10	B = 26.2mm 30, 50 = M8, M6	

DSN970		12V	1.8kW
10 C = 163mm Mb = 2xØ11	ØA = 76.2mm D = 156mm	B = 52.5mm 30, 50 = M8, M6	

DSN970		12V	1.8kW
10 C = 163mm Mb = 2xØ11	ØA = 76.2mm D = 156mm	B = 52.5mm 30, 50 = M8, M6	

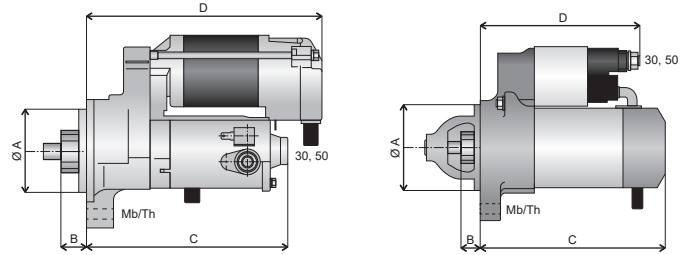

DSN971		12V	1.3kW
10			

DSN971		12V	1.3kW
10			



DSN975		12V	1.4kW
10	<p>ØA = 76.2mm</p> <p>D = 140mm</p>	<p>B = 20mm</p> <p>30, 50 = M8, Plug</p>	
<p>C = 135mm</p> <p>Mb = 3xØ8.5</p>			



DSN975		12V	1.4kW
10	<p>ØA = 76.2mm</p> <p>D = 140mm</p>	<p>B = 20mm</p> <p>30, 50 = M8, Plug</p>	
<p>C = 135mm</p> <p>Mb = 3xØ8.5</p>			

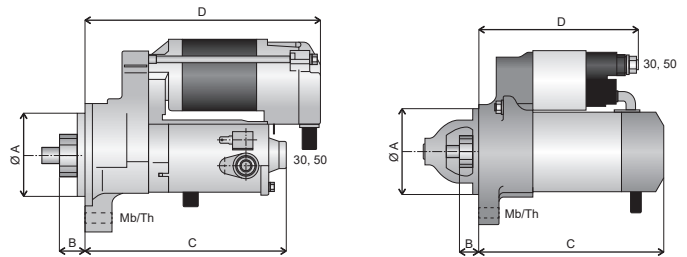

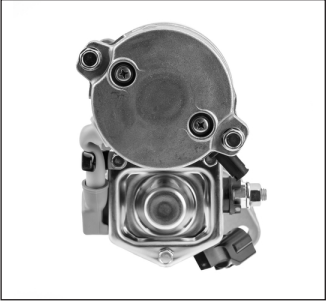
DSN976		12V	2kW
9	<p>ØA = 70mm</p> <p>D = 166mm</p> <p>Th = 2xM10, 2xM8</p>	<p>B = 25mm</p> <p>30, 50 = M8, M6</p>	
<p>C = 211mm</p>			

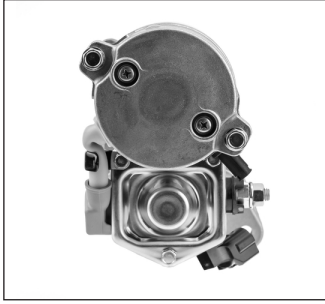

DSN976		12V	2kW
9	<p>ØA = 70mm</p> <p>D = 166mm</p> <p>Th = 2xM10, 2xM8</p>	<p>B = 25mm</p> <p>30, 50 = M8, M6</p>	
<p>C = 211mm</p>			





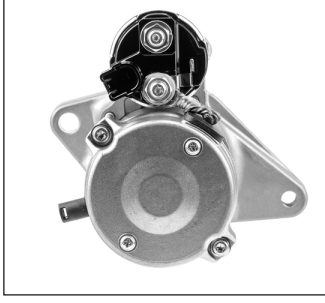

DSN978		12V	2kW
 			
 10 C = 130mm	ØA = 74mm D = 185mm Th = 2xM10	B = 22mm	30, 50 = M8, Plug

DSN978		12V	2kW
 			
 10 C = 130mm	ØA = 74mm D = 185mm Th = 2xM10	B = 22mm	30, 50 = M8, Plug

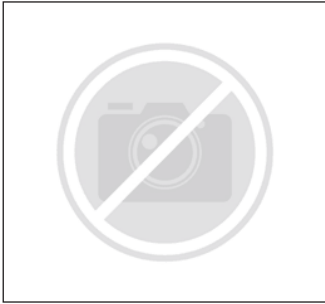
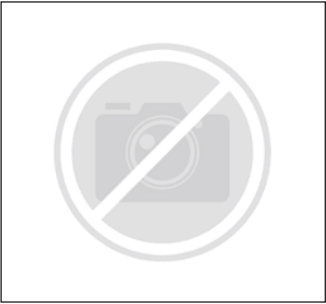
DSN980		12V	1.3kW
 			
 9 C = 144mm Mb = 1xØ11	ØA = 74mm D = 133mm Th = 1xM10	B = 11.5mm	30, 50 = M8, Plug

DSN980		12V	1.3kW
 			
 9 C = 144mm Mb = 1xØ11	ØA = 74mm D = 133mm Th = 1xM10	B = 11.5mm	30, 50 = M8, Plug

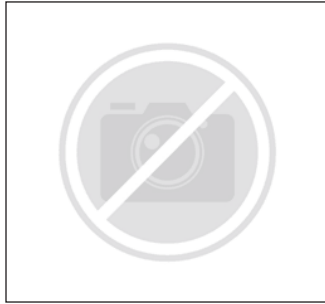
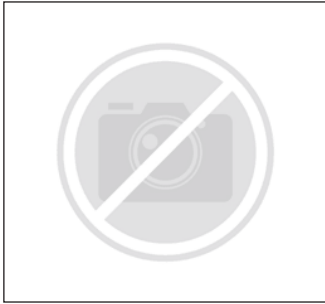
DSN984		12V	2kW
 			
 11 C = 170mm Mb = 1xØ13	ØA = 74mm D = 118mm Th = 1xM12	B = 24.8mm	30, 50 = M8, Plug

DSN984		12V	2kW
 			
 11 C = 170mm Mb = 1xØ13	ØA = 74mm D = 118mm Th = 1xM12	B = 24.8mm	30, 50 = M8, Plug

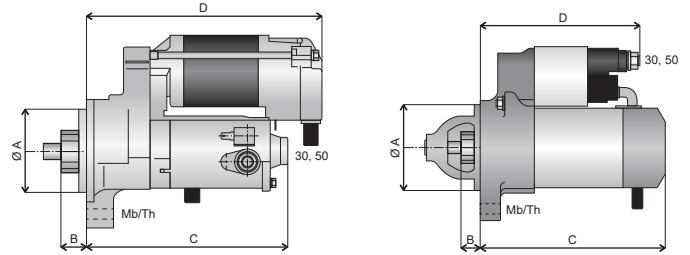

DSN986		12V	1.6kW
15 C = 167mm Mb = 1xØ11	ØA = 74mm D = 150mm Th = 1xM10	B = 27mm 30, 50 = M8, Plug	

DSN986		12V	1.6kW
15 C = 167mm Mb = 1xØ11	ØA = 74mm D = 150mm Th = 1xM10	B = 27mm 30, 50 = M8, Plug	

DSN987		12V	1.6kW
15 C = 167mm Mb = 1xØ11	ØA = 74mm D = 150mm Th = 1xM10	B = 27mm 30, 50 = M8, Plug	

DSN987		12V	1.6kW
15 C = 167mm Mb = 1xØ11	ØA = 74mm D = 150mm Th = 1xM10	B = 27mm 30, 50 = M8, Plug	

DSN988		12V	0.8kW
8 C = 144mm Mb = 1xØ11	ØA = 74mm D = 145mm Th = 1xM10	B = 25.7mm 30, 50 = M8, Plug	

DSN988		12V	0.8kW
8 C = 144mm Mb = 1xØ11	ØA = 74mm D = 145mm Th = 1xM10	B = 25.7mm 30, 50 = M8, Plug	

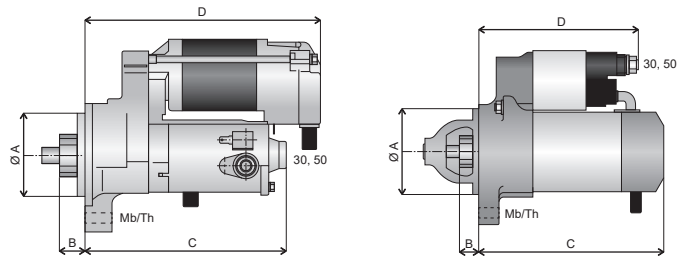

DSN989		12V	1.9kW
11	ØA = 74mm	B = 24.8mm	
C = 175mm	D = 124mm	30, 50 = M8, Plug	
Mb = 1xØ13	Th = 1xM12		

DSN989		12V	1.9kW
11	ØA = 74mm	B = 24.8mm	
C = 175mm	D = 124mm	30, 50 = M8, Plug	
Mb = 1xØ13	Th = 1xM12		

DSN994		12V	1.8kW
11	ØA = 66mm	B = 23mm	
C = 168mm	D = 158mm	30, 50 = M8, Plug	
Mb = 1xØ11	Th = 1xM12		

DSN994		12V	1.8kW
11	ØA = 66mm	B = 23mm	
C = 168mm	D = 158mm	30, 50 = M8, Plug	
Mb = 1xØ11	Th = 1xM12		

DSN999		12V	1kW
9	ØA = 74mm	B = 20mm	
C = 158mm	D = 136mm	30, 50 = M8, Plug	
	Th = 2xM10		

DSN999		12V	1kW
9	ØA = 74mm	B = 20mm	
C = 158mm	D = 136mm	30, 50 = M8, Plug	
	Th = 2xM10		

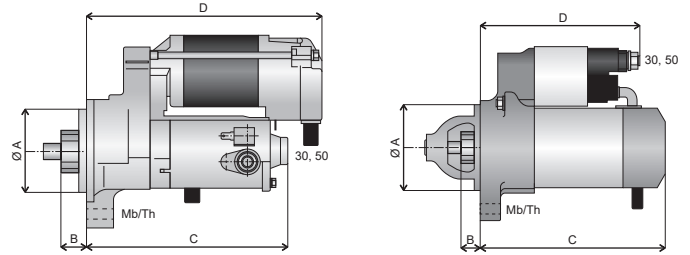

DSN1001		12V	2kW
10 C = 133mm Mb = 1xØ13	ØA = 82.5mm D = 189mm Th = 1xM12	B = 18mm 30, 50 = M8, Plug	

DSN1001		12V	2kW
10 C = 133mm Mb = 1xØ13	ØA = 82.5mm D = 189mm Th = 1xM12	B = 18mm 30, 50 = M8, Plug	



DSN1003		12V	1.7kW
13 C = 128mm Mb = 2xØ11.3	ØA = 55mm D = 125mm	B = 66mm 30, 50 = M8, Plug	



DSN1003		12V	1.7kW
13 C = 128mm Mb = 2xØ11.3	ØA = 55mm D = 125mm	B = 66mm 30, 50 = M8, Plug	

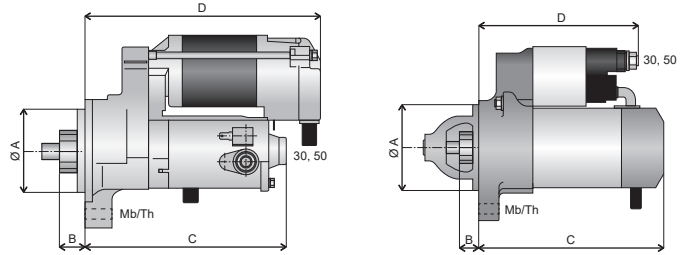

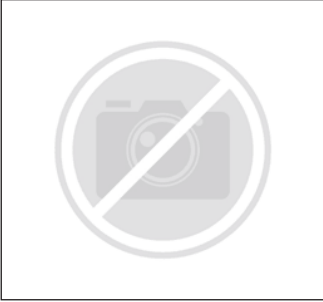
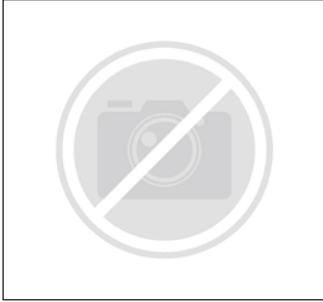
DSN1008		12V	1.7kW
15 C = 160mm Mb = 2xØ9	ØA = 68mm D = 157mm	B = 18.5mm 30, 50 = M8, M6	

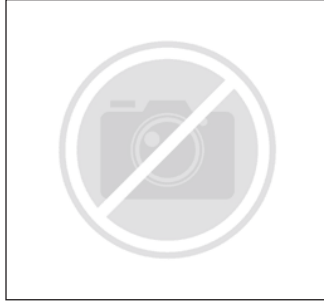
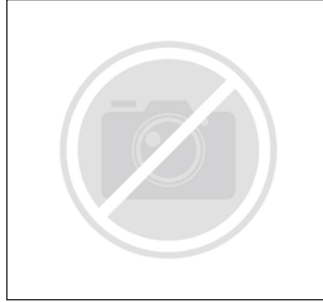

DSN1008		12V	1.7kW
15 C = 160mm Mb = 2xØ9	ØA = 68mm D = 157mm	B = 18.5mm 30, 50 = M8, M6	









DSN1009		12V	1.2kW
 			
 9 C = 121mm Mb = 1xØ11	ØA = 74mm D = 126mm Th = 1xM10	B = 24mm 30, 50 = M8, Plug	

DSN1009		12V	1.2kW
 			
 9 C = 121mm Mb = 1xØ11	ØA = 74mm D = 126mm Th = 1xM10	B = 24mm 30, 50 = M8, Plug	



DSN1201		12V	1.5kW
 			
 11 C = 153mm Mb = 1xØ11	ØA = 66mm D = 148mm Th = 1xM12	B = 23mm 30, 50 = M8, Plug	



DSN1201		12V	1.5kW
 			
 11 C = 153mm Mb = 1xØ11	ØA = 66mm D = 148mm Th = 1xM12	B = 23mm 30, 50 = M8, Plug	

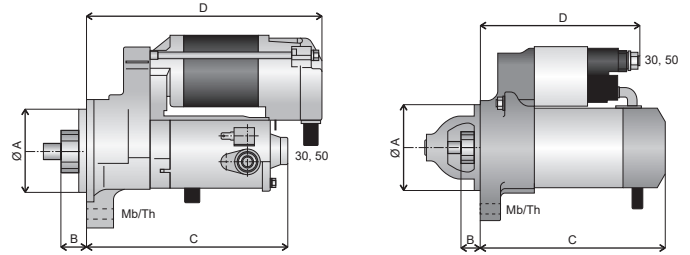

DSN1203		12V	1.9kW
 			
 11 C = 188mm Mb = 1xØ11	ØA = 66mm D = 148mm Th = 1xM12	B = 23mm 30, 50 = M8, Plug	



DSN1203		12V	1.9kW
 			
 11 C = 188mm Mb = 1xØ11	ØA = 66mm D = 148mm Th = 1xM12	B = 23mm 30, 50 = M8, Plug	









DSN1204		12V	1.7kW
 			
 11 C = 168mm Mb = 1xØ11	ØA = 66mm D = 158mm Th = 1xM12	B = 23mm 30, 50 = M8, Plug	

DSN1204		12V	1.7kW
 			
 11 C = 168mm Mb = 1xØ11	ØA = 66mm D = 158mm Th = 1xM12	B = 23mm 30, 50 = M8, Plug	



DSN1205		12V	1.7kW
 			
 13 C = 155mm	ØA = 66mm D = 149mm Th = 2xM10	B = 27.3mm 30, 50 = M8, M6	



DSN1205		12V	1.7kW
 			
 13 C = 155mm	ØA = 66mm D = 149mm Th = 2xM10	B = 27.3mm 30, 50 = M8, M6	

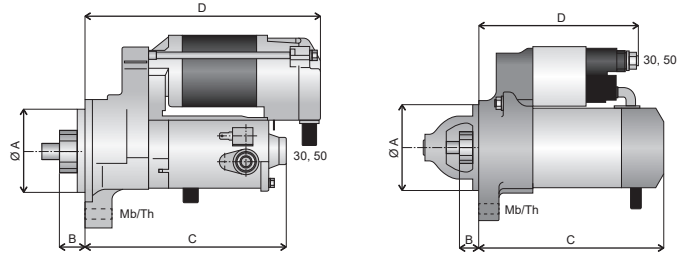

DSN1206		12V	1.7kW
 			
 15 C = 143mm Mb = 2xØ11	ØA = 74mm D = 137mm	B = 53.5mm 30, 50 = M8, M6	

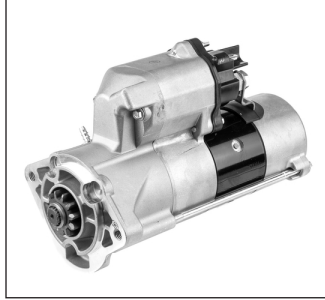

DSN1206		12V	1.7kW
 			
 15 C = 143mm Mb = 2xØ11	ØA = 74mm D = 137mm	B = 53.5mm 30, 50 = M8, M6	







DSN1207			12V	2.7kW
				
 11	ØA = 80mm	B = 17mm		
C = 255mm	D = 190mm	30, 50 = M10, M5		
	Th = 2xM10			

DSN1207			12V	2.7kW
				
 11	ØA = 80mm	B = 17mm		
C = 255mm	D = 190mm	30, 50 = M10, M5		
	Th = 2xM10			

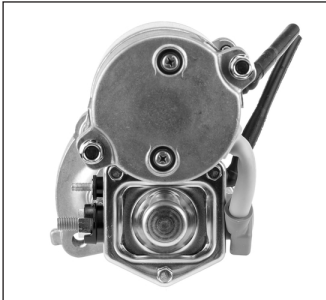

DSN1208			12V	2kW
				
 10	ØA = 48mm	B = 5mm		
C = 157mm	D = 213mm	30, 50 = M8, M5		
	Th = 3xM10			

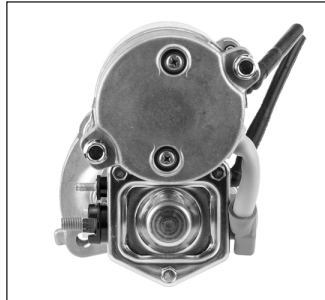
DSN1208			12V	2kW
				
 10	ØA = 48mm	B = 5mm		
C = 157mm	D = 213mm	30, 50 = M8, M5		
	Th = 3xM10			

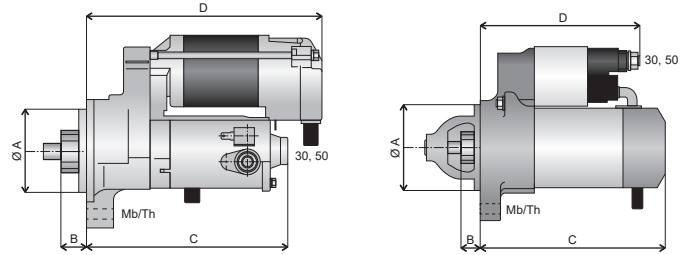

DSN1209			12V	2kW
				
 9	ØA = 48mm	B = -5mm		
C = 157mm	D = 213mm	30, 50 = M8, M5		
	Th = 3xM10			



DSN1209			12V	2kW
				
 9	ØA = 48mm	B = -5mm		
C = 157mm	D = 213mm	30, 50 = M8, M5		
	Th = 3xM10			









DSN1210		12V	2.7kW
 			
 12 C = 237mm	ØA = 91mm D = 186mm Th = 2xM12	B = 33.5mm 30, 50 = M10, Plug	

DSN1210		12V	2.7kW
 			
 12 C = 237mm	ØA = 91mm D = 186mm Th = 2xM12	B = 33.5mm 30, 50 = M10, Plug	

DSN1211		12V	2.2kW
 			
 10 C = 164mm Mb = 1xØ13	ØA = 82.5mm D = 204mm Th = 1xM12	B = 18mm 30, 50 = M8, Plug	

DSN1211		12V	2.2kW
 			
 10 C = 164mm Mb = 1xØ13	ØA = 82.5mm D = 204mm Th = 1xM12	B = 18mm 30, 50 = M8, Plug	

DSN1213		12V	1.0kW
 			
 9 C = 164mm Mb = 1xØ11	ØA = 74mm D = 142mm Th = 1xM10	B = 14mm 30, 50 = M8, Plug	

DSN1213		12V	1.0kW
 			
 9 C = 164mm Mb = 1xØ11	ØA = 74mm D = 142mm Th = 1xM10	B = 14mm 30, 50 = M8, Plug	

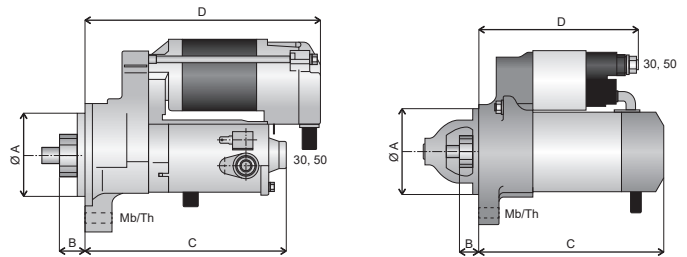

DSN1215		12V	1kW
9	ØA = 74mm	B = 25.7mm	
C = 152mm	D = 120mm	30, 50 = M8, Plug	
Mb = 1xØ11	Th = 1xM10		

DSN1215		12V	1kW
9	ØA = 74mm	B = 25.7mm	
C = 152mm	D = 120mm	30, 50 = M8, Plug	
Mb = 1xØ11	Th = 1xM10		



DSN1220		12V	1.6kW
10	ØA = 74mm	B = 22mm	
C = 127mm	D = 122mm	30, 50 = M8, Plug	
	Th = 2xM10		



DSN1220		12V	1.6kW
10	ØA = 74mm	B = 22mm	
C = 127mm	D = 122mm	30, 50 = M8, Plug	
	Th = 2xM10		

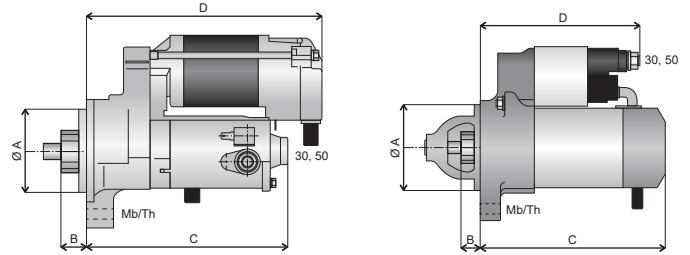

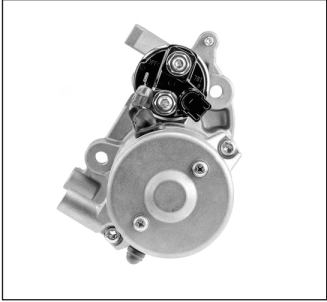
DSN1221		12V	0.8kW
8	ØA = 74mm	B = 25.7mm	
C = 144mm	D = 136mm	30, 50 = M8, Plug	
Mb = 1xØ11	Th = 1xM10		

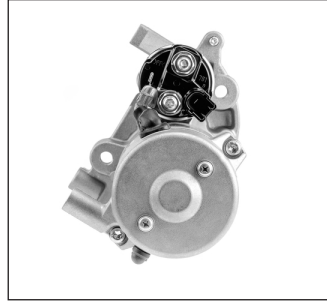

DSN1221		12V	0.8kW
8	ØA = 74mm	B = 25.7mm	
C = 144mm	D = 136mm	30, 50 = M8, Plug	
Mb = 1xØ11	Th = 1xM10		









DSN1222		12V	2kW
 			
 9 C = 169mm	ØA = 74mm D = 118mm Th = 2xM10	B = 26mm 30, 50 = M8, Plug	

DSN1222		12V	2kW
 			
 9 C = 169mm	ØA = 74mm D = 118mm Th = 2xM10	B = 26mm 30, 50 = M8, Plug	

DSN1223		12V	2kW
 			
 9 C = 120mm	ØA = 55mm D = 175mm Th = 2xM10, 1xM8	B = 33mm 30, 50 = M8, Plug	

DSN1223		12V	2kW
 			
 9 C = 120mm	ØA = 55mm D = 175mm Th = 2xM10, 1xM8	B = 33mm 30, 50 = M8, Plug	

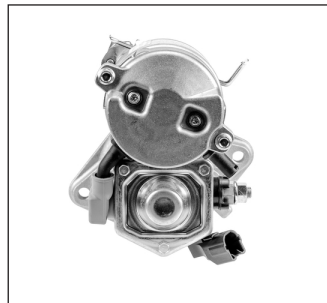
DSN1224		12V	1.4kW
 			
 10 C = 148mm	ØA = 74mm D = 172mm Th = 2xM10	B = 3.2mm 30, 50 = M8, Plug	

DSN1224		12V	1.4kW
 			
 10 C = 148mm	ØA = 74mm D = 172mm Th = 2xM10	B = 3.2mm 30, 50 = M8, Plug	

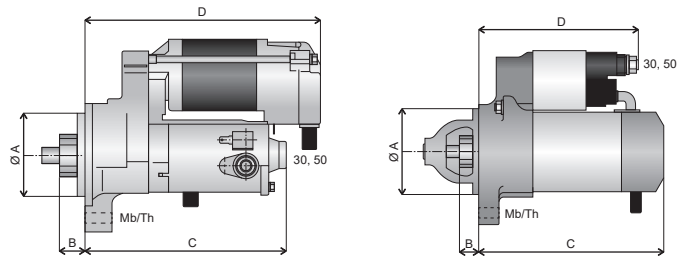

DSN1225			12V	1.4kW
9	ØA = 74mm	B = 20mm		
C = 132mm	D = 155mm	30, 50 = M8, Plug		
	Th = 2xM10			

DSN1225			12V	1.4kW
9	ØA = 74mm	B = 20mm		
C = 132mm	D = 155mm	30, 50 = M8, Plug		
	Th = 2xM10			

DSN1228			24V	4.5kW
12	ØA = 91mm	B = 16mm		
C = 220mm	D = 258mm	30, 50 = M10, Plug		
Mb = 2xØ13				

DSN1228			24V	4.5kW
12	ØA = 91mm	B = 16mm		
C = 220mm	D = 258mm	30, 50 = M10, Plug		
Mb = 2xØ13				

DSN1229			12V	2.7kW
11	ØA = 82.5mm	B = 18mm		
C = 213mm	D = 208mm	30, 50 = M10, Plug		
Mb = 1xØ13	Th = 1xM12			

DSN1229			12V	2.7kW
11	ØA = 82.5mm	B = 18mm		
C = 213mm	D = 208mm	30, 50 = M10, Plug		
Mb = 1xØ13	Th = 1xM12			

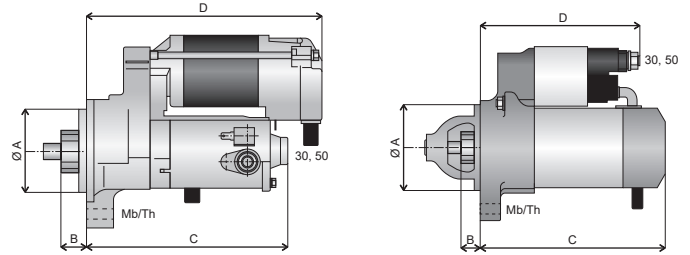

DSN1234		12V	2.0kW
9 C = 155mm Mb = 1xØ11	ØA = 74mm D = 136mm Th = 1xM10	B = 13mm 30, 50 = M8, Plug	

DSN1234		12V	2.0kW
9 C = 155mm Mb = 1xØ11	ØA = 74mm D = 136mm Th = 1xM10	B = 13mm 30, 50 = M8, Plug	



DSN1235		12V	2kW
9 C = 142mm Mb = 1xØ13	ØA = 74mm D = 120mm Th = 1xM12	B = 24.8mm 30, 50 = M8, Plug	



DSN1235		12V	2kW
9 C = 142mm Mb = 1xØ13	ØA = 74mm D = 120mm Th = 1xM12	B = 24.8mm 30, 50 = M8, Plug	

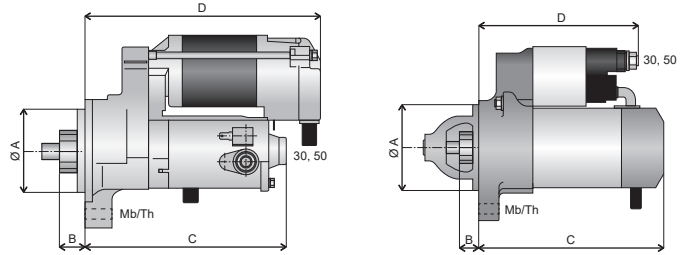

DSN1236		12V	2kW
9 C = 141mm	ØA = 74mm D = 118mm Th = 2xM10	B = 26mm 30, 50 = M8, Plug	

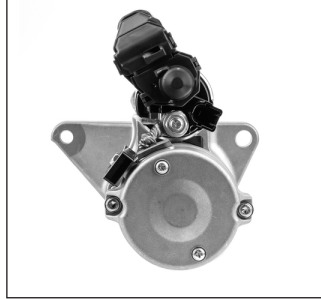

DSN1236		12V	2kW
9 C = 141mm	ØA = 74mm D = 118mm Th = 2xM10	B = 26mm 30, 50 = M8, Plug	







DSN1238		12V	1.7kW
			
 11	ØA = 74mm	B = 13mm	
C = 158mm	D = 136mm	30, 50 = M8, Plug	
Mb = 1xØ11	Th = 1xM10		

DSN1238		12V	1.7kW
			
 11	ØA = 74mm	B = 13mm	
C = 158mm	D = 136mm	30, 50 = M8, Plug	
Mb = 1xØ11	Th = 1xM10		

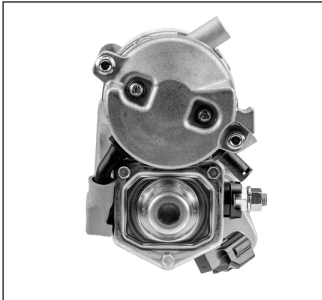
DSN1239		12V	1.3kW
			
 10	ØA = 74mm	B = 14mm	
C = 135mm	D = 130mm	30, 50 = M8, Plug	
Mb = 1xØ11	Th = 1xM10		

DSN1239		12V	1.3kW
			
 10	ØA = 74mm	B = 14mm	
C = 135mm	D = 130mm	30, 50 = M8, Plug	
Mb = 1xØ11	Th = 1xM10		

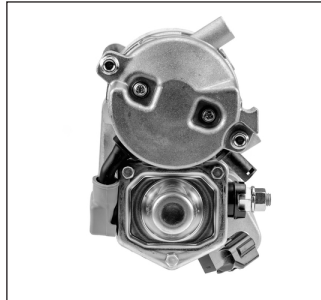
DSN1241		12V	1.4kW
			
 10	ØA = 74mm	B = 22mm	
C = 130mm	D = 153mm	30, 50 = M8, Plug	
	Th = 2xM10		

DSN1241		12V	1.4kW
			
 10	ØA = 74mm	B = 22mm	
C = 130mm	D = 153mm	30, 50 = M8, Plug	
	Th = 2xM10		

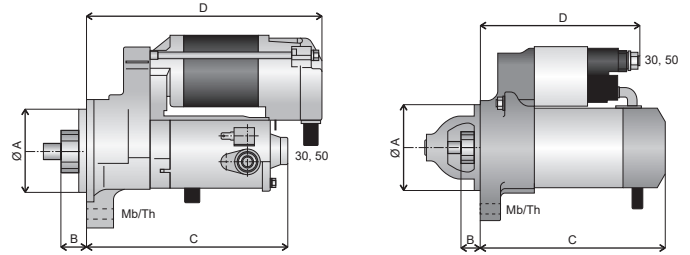

DSN1256		12V	1.7kW
10 C = 125mm	ØA = 74mm D = 122mm Th = 2xM10	B = 22.2mm 30, 50 = M8, Plug	

DSN1256		12V	1.7kW
10 C = 125mm	ØA = 74mm D = 122mm Th = 2xM10	B = 22.2mm 30, 50 = M8, Plug	

DSN1300		12V	2kW
9 C = 211mm Mb = 1xØ10.4	ØA = 70mm D = 173mm Th = 1xM10, 2xM8	B = 25mm 30, 50 = M8, M6	

DSN1300		12V	2kW
9 C = 211mm Mb = 1xØ10.4	ØA = 70mm D = 173mm Th = 1xM10, 2xM8	B = 25mm 30, 50 = M8, M6	

DSN1301		12V	2kW
11 C = 206mm	ØA = 76.2mm D = 170mm Th = 3xM8	B = 1mm 30, 50 = M8, M6	

DSN1301		12V	2kW
11 C = 206mm	ØA = 76.2mm D = 170mm Th = 3xM8	B = 1mm 30, 50 = M8, M6	

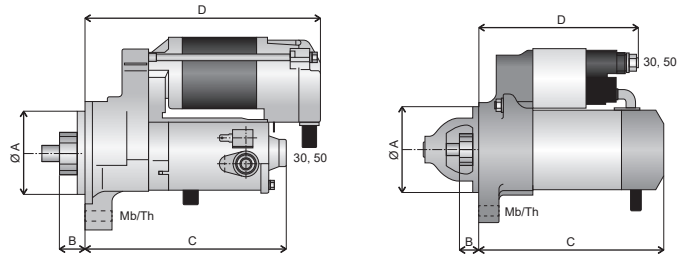

DSN1364		12V	1.4kW
10	ØA = 62mm	B = 26.5mm	
C = 130mm	D = 154mm	30, 50 = M8, M5	
	Th = 2xM10		

DSN1364		12V	1.4kW
10	ØA = 62mm	B = 26.5mm	
C = 130mm	D = 154mm	30, 50 = M8, M5	
	Th = 2xM10		

DSN1365		12V	1.9kW
13	ØA = 54mm	B = 1mm	
C = 208mm	D = 168mm	30, 50 = M8, Plug	
	Th = 3xM10		

DSN1365		12V	1.9kW
13	ØA = 54mm	B = 1mm	
C = 208mm	D = 168mm	30, 50 = M8, Plug	
	Th = 3xM10		

DSN1368		12V	1kW
10	ØA = 72mm	B = 14mm	
C = 130mm	D = 142mm	30, 50 = M8, Plug	
Mb = 2xØ9	Th = 1xM8		

DSN1368		12V	1kW
10	ØA = 72mm	B = 14mm	
C = 130mm	D = 142mm	30, 50 = M8, Plug	
Mb = 2xØ9	Th = 1xM8		

Starters & Alternators

Photo Guide – Starters

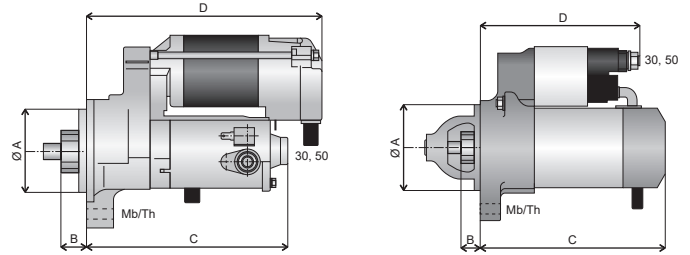

DSN1370		12V	1.6kW
<p>☀️ 13</p> <p>C = 143mm</p> <p>Mb = 2xØ11.3</p>	<p>ØA = 55mm</p> <p>D = 125mm</p>	<p>B = 66mm</p> <p>30, 50 = M8, Plug</p>	

DSN1370		12V	1.6kW
<p>☀️ 13</p> <p>C = 143mm</p> <p>Mb = 2xØ11.3</p>	<p>ØA = 55mm</p> <p>D = 125mm</p>	<p>B = 66mm</p> <p>30, 50 = M8, Plug</p>	

DSN1371		12V	2.7kW
<p>☀️ 11</p>			

DSN1371		12V	2.7kW
<p>☀️ 11</p>			

DSN1373		12V	2.2kW
<p>☀️ 10</p>			

DSN1373		12V	2.2kW
<p>☀️ 10</p>			

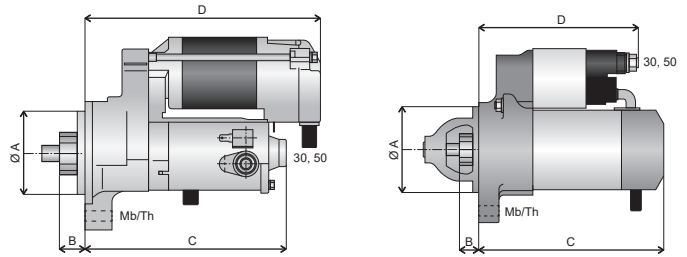

DSN1374		12V	2.0kW
10			

DSN1374		12V	2.0kW
10			

DSN1375		12V	1.3kW
9	$\text{ØA} = 76.2\text{mm}$	$B = 26\text{mm}$	
$C = 130\text{mm}$	$D = 126\text{mm}$	$30, 50 = \text{M8, Plug}$	
$\text{Mb} = 1 \times \text{Ø}11.5$	$\text{Th} = 1 \times \text{M}10$		

DSN1375		12V	1.3kW
9	$\text{ØA} = 76.2\text{mm}$	$B = 26\text{mm}$	
$C = 130\text{mm}$	$D = 126\text{mm}$	$30, 50 = \text{M8, Plug}$	
$\text{Mb} = 1 \times \text{Ø}11.5$	$\text{Th} = 1 \times \text{M}10$		

DSN1376		12V	1.6kW
13	$\text{ØA} = 76.2\text{mm}$	$B = 26\text{mm}$	
$C = 150\text{mm}$	$D = 147\text{mm}$	$30, 50 = \text{M8, Plug}$	
$\text{Mb} = 1 \times \text{Ø}11.5$	$\text{Th} = 1 \times \text{M}10$		

DSN1376		12V	1.6kW
13	$\text{ØA} = 76.2\text{mm}$	$B = 26\text{mm}$	
$C = 150\text{mm}$	$D = 147\text{mm}$	$30, 50 = \text{M8, Plug}$	
$\text{Mb} = 1 \times \text{Ø}11.5$	$\text{Th} = 1 \times \text{M}10$		

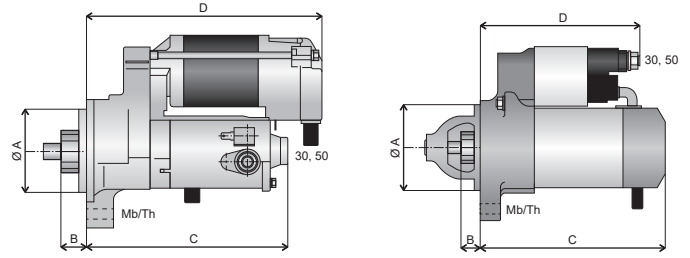

DSN1377		12V	1.6kW
9	ØA = 61mm	B = 26.8mm	
C = 165mm	D = 153mm	30, 50 = M8, Plug	
Mb = 1xØ6	Th = 2xM10		

DSN1377		12V	1.6kW
9	ØA = 61mm	B = 26.8mm	
C = 165mm	D = 153mm	30, 50 = M8, Plug	
Mb = 1xØ6	Th = 2xM10		

DSN1378		12V	1.6kW
13	ØA = 57mm	B = 26.8mm	
C = 165mm	D = 147mm	30, 50 = M8, Plug	
Mb = 1xØ6	Th = 2xM10		

DSN1378		12V	1.6kW
13	ØA = 57mm	B = 26.8mm	
C = 165mm	D = 147mm	30, 50 = M8, Plug	
Mb = 1xØ6	Th = 2xM10		

DSN1383		12V	1.8kW
9			

DSN1383		12V	1.8kW
9			

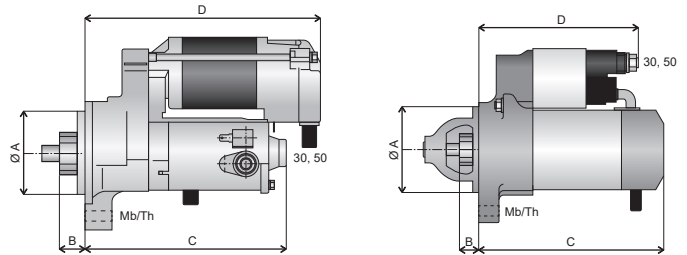

DSN1384		12V	1.3kW
11	ØA = 97.5mm	B = 18mm	
C = 140mm	D = 138mm	30, 50 = M8, M6	
Mb = 2xØ10.5	Th = 1xM8		

DSN1384		12V	1.3kW
11	ØA = 97.5mm	B = 18mm	
C = 140mm	D = 138mm	30, 50 = M8, M6	
Mb = 2xØ10.5	Th = 1xM8		



DSN1385		12V	1kW
9	ØA = 70mm	B = 33mm	
C = 145mm	D = 134mm	30, 50 = M8, Plug	
Mb = 1xØ11	Th = 1xM12		



DSN1385		12V	1kW
9	ØA = 70mm	B = 33mm	
C = 145mm	D = 134mm	30, 50 = M8, Plug	
Mb = 1xØ11	Th = 1xM12		

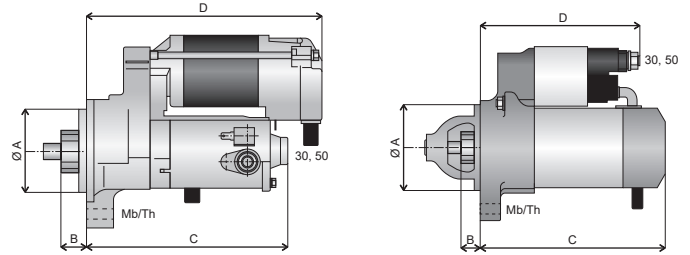

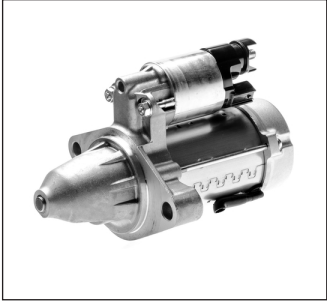
DSN1386		12V	2.0kW
HONDA			
9	ØA = 75mm	B = 38.5mm	
C = 174mm	D = 132mm	30, 50 = M8, Plug	
Mb = 1xØ13, 1xØ11			

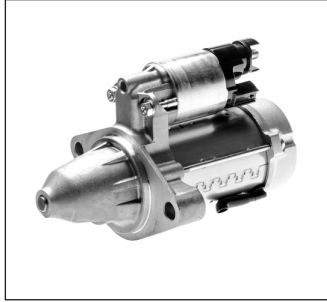
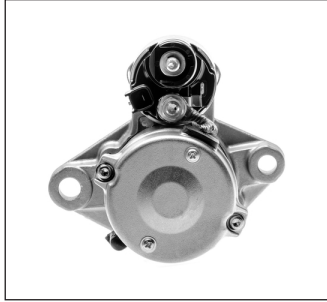

DSN1386		12V	2.0kW
HONDA			
9	ØA = 75mm	B = 38.5mm	
C = 174mm	D = 132mm	30, 50 = M8, Plug	
Mb = 1xØ13, 1xØ11			









DSN1387		12V	1.8kW
 			
 10 C = 144mm Mb = 1xØ13, 1xØ11	ØA = 75mm D = 130mm	B = 38.5mm 30, 50 = M8, Plug	

DSN1387		12V	1.8kW
 			
 10 C = 144mm Mb = 1xØ13, 1xØ11	ØA = 75mm D = 130mm	B = 38.5mm 30, 50 = M8, Plug	

DSN1389		12V	1kW
 			
 9 C = 150mm Mb = 1xØ13, 1xØ10.5	ØA = 75mm D = 150mm	B = 33mm 30, 50 = M8, Plug	

DSN1389		12V	1kW
 			
 9 C = 150mm Mb = 1xØ13, 1xØ10.5	ØA = 75mm D = 150mm	B = 33mm 30, 50 = M8, Plug	

DSN1390		12V	1.2kW
 			
 9 C = 155mm Mb = 1xØ13, 1xØ10.5	ØA = 75mm D = 155mm	B = 33mm 30, 50 = M8, Plug	

DSN1390		12V	1.2kW
 			
 9 C = 155mm Mb = 1xØ13, 1xØ10.5	ØA = 75mm D = 155mm	B = 33mm 30, 50 = M8, Plug	

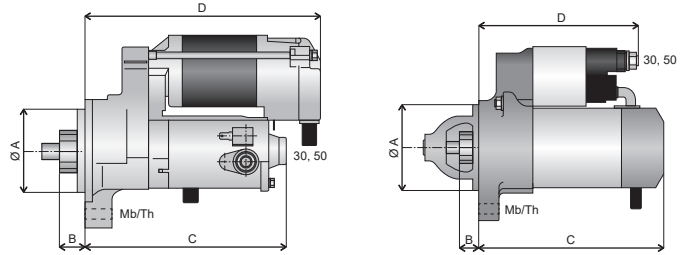

DSN1391		12V	1.2kW
9	ØA = 75mm	B = 33mm	
C = 155mm	D = 155mm	30, 50 = M8, Plug	
Mb = 1xØ13, 1xØ10.5			

DSN1391		12V	1.2kW
9	ØA = 75mm	B = 33mm	
C = 155mm	D = 155mm	30, 50 = M8, Plug	
Mb = 1xØ13, 1xØ10.5			

DSN1398		12V	0.7kW
9	ØA = 70mm	B = 33mm	
C = 134mm	D = 134mm	30, 50 = M8, Plug	
Mb = 1xØ11	Th = 1xM12		

DSN1398		12V	0.7kW
9	ØA = 70mm	B = 33mm	
C = 134mm	D = 134mm	30, 50 = M8, Plug	
Mb = 1xØ11	Th = 1xM12		

DSN1406		12V	1kW
9	ØA = 75mm	B = 33mm	
C = 150mm	D = 150mm	30, 50 = M8, Plug	
Mb = 1xØ13, 1xØ10.5			

DSN1406		12V	1kW
9	ØA = 75mm	B = 33mm	
C = 150mm	D = 150mm	30, 50 = M8, Plug	
Mb = 1xØ13, 1xØ10.5			

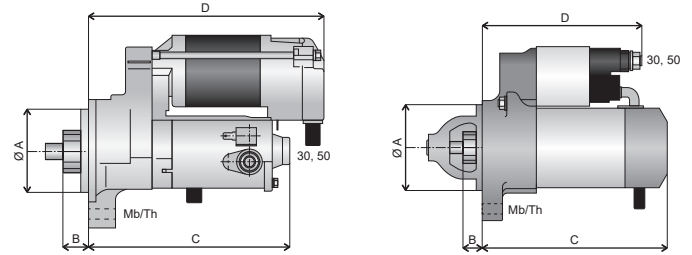

DSN1408		12V	1kW
9	ØA = 75mm	B = 33mm	
C = 150mm	D = 135mm	30, 50 = M8, Plug	
Mb = 1xØ13, 1xØ10.5			

DSN1408		12V	1kW
9	ØA = 75mm	B = 33mm	
C = 150mm	D = 135mm	30, 50 = M8, Plug	
Mb = 1xØ13, 1xØ10.5			

DSN1410		12V	1.7kW
11	ØA = 62mm	B = 34mm	
C = 143mm	D = 128mm	30, 50 = M8, M6	
Mb = 1xØ11	Th = 1xM10		

DSN1410		12V	1.7kW
11	ØA = 62mm	B = 34mm	
C = 143mm	D = 128mm	30, 50 = M8, M6	
Mb = 1xØ11	Th = 1xM10		

DSN1411		12V	1.7kW
13	ØA = 97.5mm	B = 18mm	
C = 152mm	D = 138mm	30, 50 = M8, M6	
Mb = 2xØ10.5	Th = 1xM8		

DSN1411		12V	1.7kW
13	ØA = 97.5mm	B = 18mm	
C = 152mm	D = 138mm	30, 50 = M8, M6	
Mb = 2xØ10.5	Th = 1xM8		

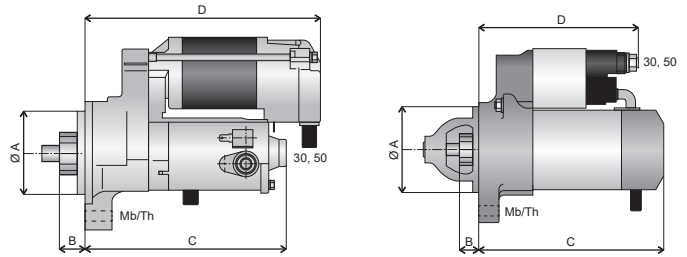

DSN1412		12V	1.7kW
11			

DSN1412		12V	1.7kW
11			

DSN1415		12V	1.9kW
12			

DSN1415		12V	1.9kW
12			

DSN1416		12V	1.9kW
12			

DSN1416		12V	1.9kW
12			

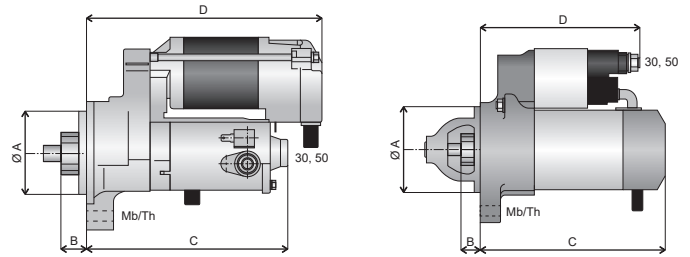

DSN1417		12V	1.9kW
11			

DSN1417		12V	1.9kW
11			



DSN1418		12V	1.9kW
11			



DSN1418		12V	1.9kW
11			

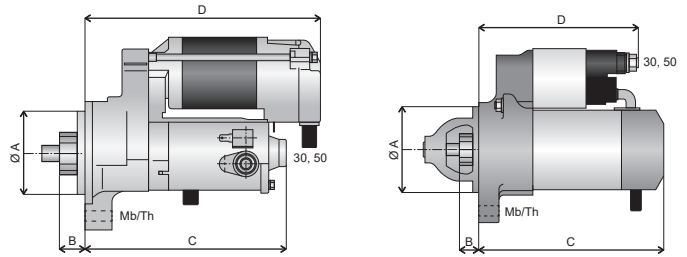

DSN1419		12V	1.4kW
10			



DSN1419		12V	1.4kW
10			









DSN1420	12V	2.7kW
		
 11		

DSN1420	12V	2.7kW
		
 11		

DSN1421	12V	2.7kW
		
 11		

DSN1421	12V	2.7kW
		
 11		

DSN1422	12V	1.9kW
		
 13		

DSN1422	12V	1.9kW
		
 13		

Starters & Alternators

Photo Guide – Starters

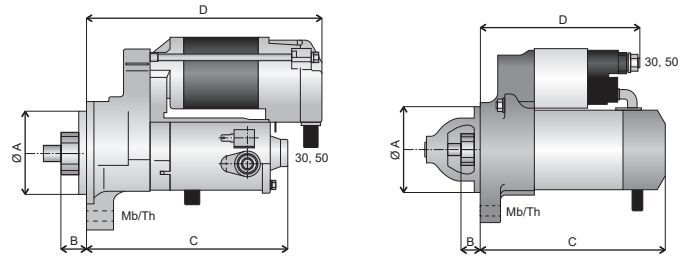

DSN1423		12V	1.9kW
13			

DSN1423		12V	1.9kW
13			

DSN1424		12V	1.9kW
13			

DSN1424		12V	1.9kW
13			

DSN1425		12V	1.9kW
13			

DSN1425		12V	1.9kW
13			

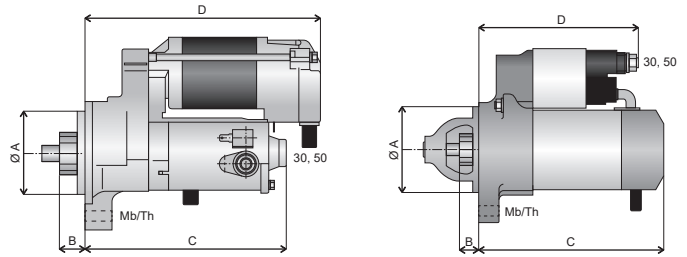

DSN1445 12V 1.8kW

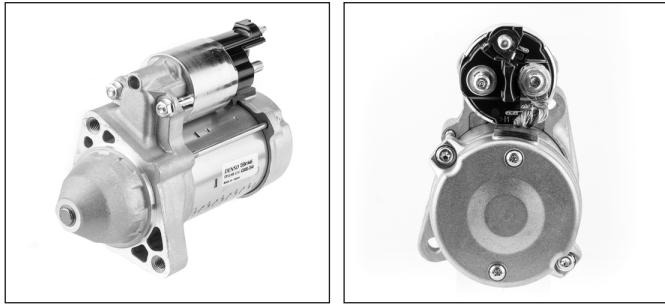

DSN1445 12V 1.8kW

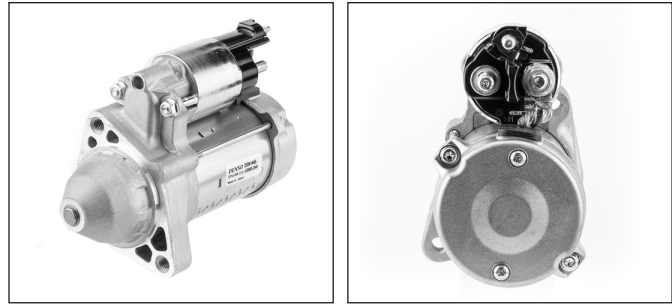

DSN1453 12V 1.9kW



DSN1453 12V 1.9kW



DSN1457 12V 1.4kW

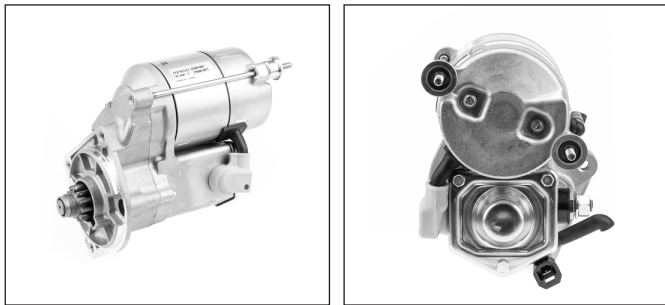

DSN1457 12V 1.4kW

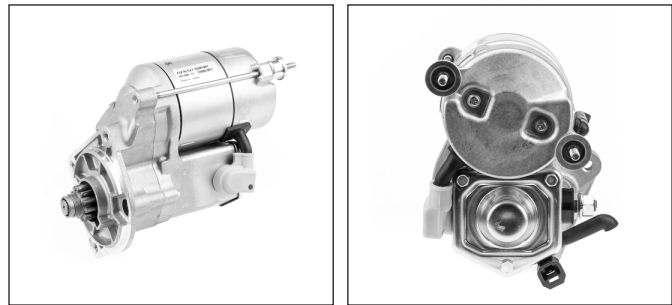

Starters & Alternators

Photo Guide – Starters

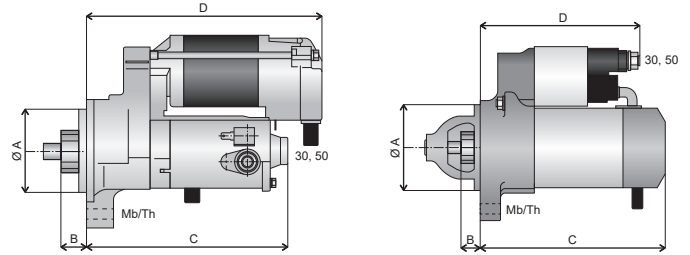

DSN1460		12V	2.0kW
13			

DSN1460		12V	2.0kW
13			

DSN1461		12V	2.0kW
13			

DSN1461		12V	2.0kW
13			

DSN1462		12V	2.0kW
13			

DSN1462		12V	2.0kW
13			

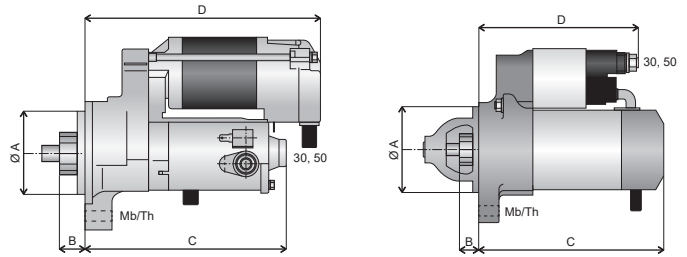

DSN1463		12V	2.0kW
13			

DSN1463		12V	2.0kW
13			

DSN1464		12V	1.5kW
13			

DSN1464		12V	1.5kW
13			



DSN1465		12V	1.5kW
13			



DSN1465		12V	1.5kW
13			

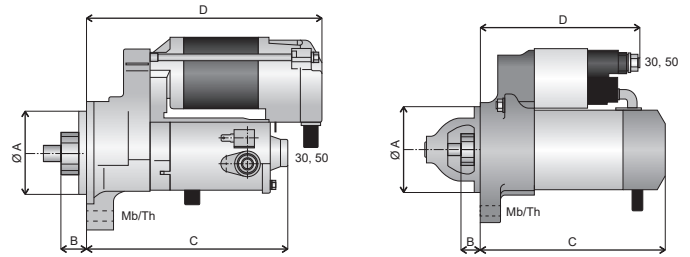

Starters & Alternators



Photo Guide – Starters









DSN1466		12V	1.5kW
			
 13			

DSN1466		12V	1.5kW
			
 13			

DSN1467		12V	2.0kW
			
 13			

DSN1467		12V	2.0kW
			
 13			

DSN1468		12V	1.5kW
			
 13			

DSN1468		12V	1.5kW
			
 13			

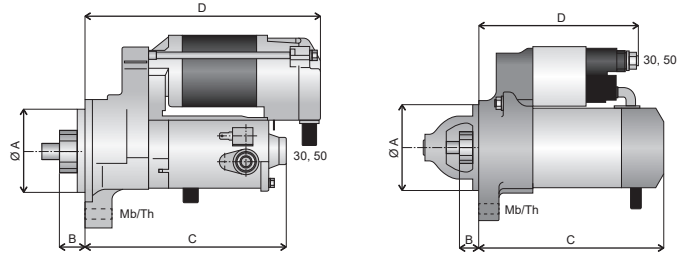

DSN1472			12V	1.6kW
TOYOTA				
13	ØA = 74mm	B = 24mm		
C = 153mm	D = 130mm	30, 50 = M8, Plug		
Mb = 1xØ11	Th = 1xM10			

DSN1472			12V	1.6kW
TOYOTA				
13	ØA = 74mm	B = 24mm		
C = 153mm	D = 130mm	30, 50 = M8, Plug		
Mb = 1xØ11	Th = 1xM10			

DSN1473			12V	1.6kW
TOYOTA				
13	ØA = 74mm	B = 24mm		
C = 153mm	D = 143mm	30, 50 = M8, Plug		
Mb = 1xØ11	Th = 1xM10			

DSN1473			12V	1.6kW
TOYOTA				
13	ØA = 74mm	B = 24mm		
C = 153mm	D = 143mm	30, 50 = M8, Plug		
Mb = 1xØ11	Th = 1xM10			

DSN1475			12V	1.7kW
TOYOTA				
13	ØA = 74mm	B = 14mm		
C = 163mm	D = 140mm	30, 50 = M8, Plug		
Mb = 1xØ11	Th = 1xM10			

DSN1475			12V	1.7kW
TOYOTA				
13	ØA = 74mm	B = 14mm		
C = 163mm	D = 140mm	30, 50 = M8, Plug		
Mb = 1xØ11	Th = 1xM10			

Starters & Alternators

Photo Guide – Starters

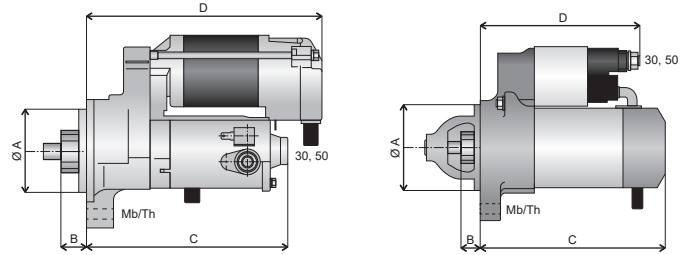

DSN1476		12V	1.6kW
9			

DSN1476		12V	1.6kW
9			



DSN1487		12V	1.7kW
SUBARU			
14	$\text{ØA} = 82.5\text{mm}$	$B = 33.5\text{mm}$	
$C = 141\text{mm}$	$D = 134\text{mm}$	$30, 50 = \text{M8, Plug}$	
$\text{Mb} = 2 \times \text{Ø}11$			



DSN1487		12V	1.7kW
SUBARU			
14	$\text{ØA} = 82.5\text{mm}$	$B = 33.5\text{mm}$	
$C = 141\text{mm}$	$D = 134\text{mm}$	$30, 50 = \text{M8, Plug}$	
$\text{Mb} = 2 \times \text{Ø}11$			

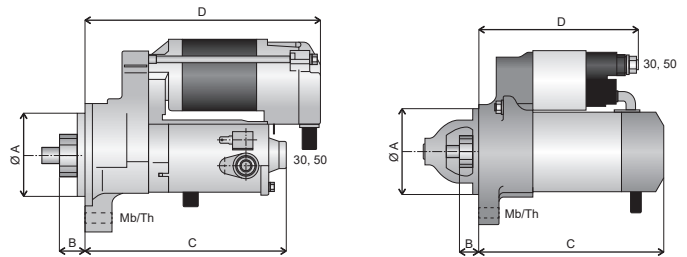

DSN1488		12V	1.4kW
ISUZU, OPEL			
9	$\text{ØA} = 81.5\text{mm}$	$B = 15\text{mm}$	
$C = 142\text{mm}$	$D = 166\text{mm}$	$30, 50 = \text{M8, Plug}$	
$\text{Mb} = 2 \times \text{Ø}10.5$			



DSN1488		12V	1.4kW
ISUZU, OPEL			
9	$\text{ØA} = 81.5\text{mm}$	$B = 15\text{mm}$	
$C = 142\text{mm}$	$D = 166\text{mm}$	$30, 50 = \text{M8, Plug}$	
$\text{Mb} = 2 \times \text{Ø}10.5$			









DSN3001			12V	1.1kW
FORD				
				
 10	ØA = 76.2mm	B = 27mm		
C = 140mm	D = 133mm	30, 50 = M8, M6		
	Th = 3xM10			

DSN3001			12V	1.1kW
FORD				
				
 10	ØA = 76.2mm	B = 27mm		
C = 140mm	D = 133mm	30, 50 = M8, M6		
	Th = 3xM10			

DSN3002			12V	1.1kW
FORD				
				
 10	ØA = 76.2mm	B = 14mm		
C = 153mm	D = 136mm	30, 50 = M8, M6		
	Th = 3xM10			

DSN3002			12V	1.1kW
FORD				
				
 10	ØA = 76.2mm	B = 14mm		
C = 153mm	D = 136mm	30, 50 = M8, M6		
	Th = 3xM10			

DSN3003			12V	1.1kW
FORD				
				
 21	ØA = 72mm	B = 15mm		
C = 161mm	D = 140mm	30, 50 = M8, M6		
Mb = 1xØ11	Th = 2xM10			

DSN3003			12V	1.1kW
FORD				
				
 21	ØA = 72mm	B = 15mm		
C = 161mm	D = 140mm	30, 50 = M8, M6		
Mb = 1xØ11	Th = 2xM10			

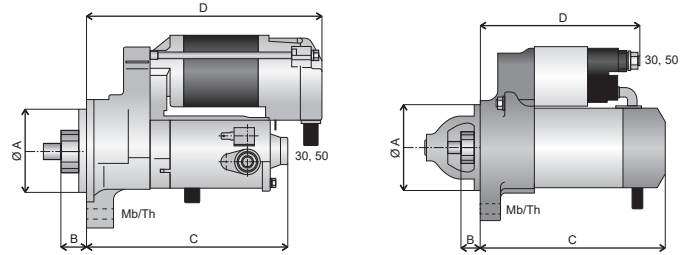

DSN3004		12V	1.4kW
PSA			
10	ØA = 66mm	B = -5mm	
C = 196mm	D = 153mm	30, 50 = M8, M5	
	Th = 3xM10		

DSN3004		12V	1.4kW
PSA			
10	ØA = 66mm	B = -5mm	
C = 196mm	D = 153mm	30, 50 = M8, M5	
	Th = 3xM10		

DSN3005		12V	1.1kW
VW Grp.			
10	ØA = 76.2mm	B = 62mm	
C = 146mm	D = 140mm	30, 50 = M8, Plug	
Mb = 2xØ12.5			

DSN3005		12V	1.1kW
VW Grp.			
10	ØA = 76.2mm	B = 62mm	
C = 146mm	D = 140mm	30, 50 = M8, Plug	
Mb = 2xØ12.5			

DSN3006		12V	1kW
VW Grp.			
10	ØA = 76.2mm	B = 53mm	
C = 146mm	D = 140mm	30, 50 = M8, Plug	
Mb = 2xØ12.5			

DSN3006		12V	1kW
VW Grp.			
10	ØA = 76.2mm	B = 53mm	
C = 146mm	D = 140mm	30, 50 = M8, Plug	
Mb = 2xØ12.5			

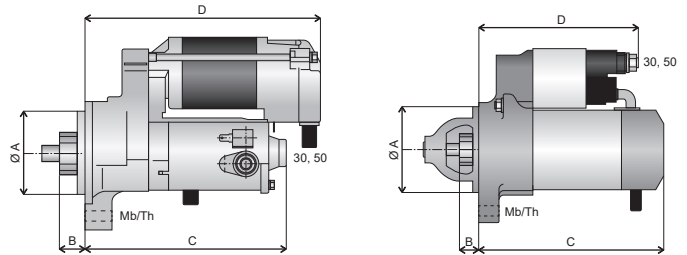

DSN3007			12V	1.7kW
VW Grp.				
10	ØA = 76.2mm	B = 53mm		
C = 175mm	D = 140mm	30, 50 = M8, Plug		
Mb = 3xØ12.5				

DSN3007			12V	1.7kW
VW Grp.				
10	ØA = 76.2mm	B = 53mm		
C = 175mm	D = 140mm	30, 50 = M8, Plug		
Mb = 3xØ12.5				

DSN3008			12V	1.7kW
VW Grp.				
10	ØA = 76.2mm	B = 43mm		
C = 196mm	D = 150mm	30, 50 = M8, Plug		
Mb = 2xØ11				

DSN3008			12V	1.7kW
VW Grp.				
10	ØA = 76.2mm	B = 43mm		
C = 196mm	D = 150mm	30, 50 = M8, Plug		
Mb = 2xØ11				

DSN3009			12V	1.1kW
OPEL				
9	ØA = 68mm	B = 19mm		
C = 149mm	D = 139mm	30, 50 = M8, M6		
Mb = 2xØ8.5				

DSN3009			12V	1.1kW
OPEL				
9	ØA = 68mm	B = 19mm		
C = 149mm	D = 139mm	30, 50 = M8, M6		
Mb = 2xØ8.5				

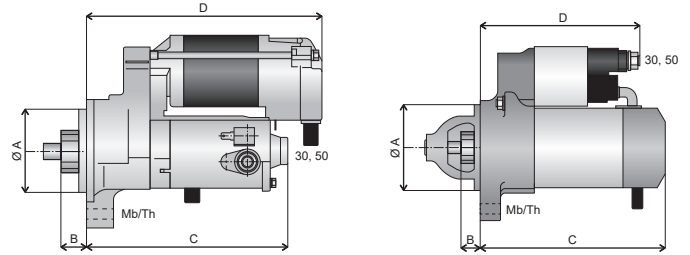

DSN3010			12V	1.1kW
MERCEDES				
9	ØA = 70mm	B = 27mm		
C = 140mm	D = 130mm	30, 50 = M8, M6		
	Th = 2xM10			

DSN3010			12V	1.1kW
MERCEDES				
9	ØA = 70mm	B = 27mm		
C = 140mm	D = 130mm	30, 50 = M8, M6		
	Th = 2xM10			

DSN3011			12V	2.2kW
MERCEDES				
10	ØA = 82.5mm	B = 26mm		
C = 175mm	D = 130mm	30, 50 = M8, M6		
	Th = 2xM10			

DSN3011			12V	2.2kW
MERCEDES				
10	ØA = 82.5mm	B = 26mm		
C = 175mm	D = 130mm	30, 50 = M8, M6		
	Th = 2xM10			

DSN3012			12V	2kW
FORD, PSA				
12	ØA = 89mm	B = 35mm		
C = 175mm	D = 133mm	30, 50 = M8, M6		
Mb = 2xØ10.5				

DSN3012			12V	2kW
FORD, PSA				
12	ØA = 89mm	B = 35mm		
C = 175mm	D = 133mm	30, 50 = M8, M6		
Mb = 2xØ10.5				

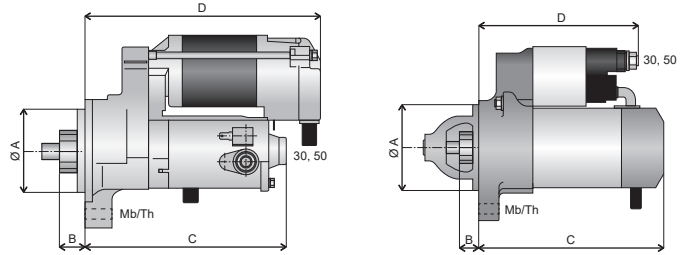

DSN3013			12V	2.5kW
FIAT, PSA				
	ØA = 82mm	B = 23mm		
C = 183mm	D = 147mm	30, 50 = M8, M6		
	Th = 3xM8			

DSN3013			12V	2.5kW
FIAT, PSA				
	ØA = 82mm	B = 23mm		
C = 183mm	D = 147mm	30, 50 = M8, M6		
	Th = 3xM8			

DSN3014			12V	2.5kW
FIAT, PSA				
	ØA = 82mm	B = 1mm		
C = 206mm	D = 163mm	30, 50 = M8, M6		
	Th = 3xM8			

DSN3014			12V	2.5kW
FIAT, PSA				
	ØA = 82mm	B = 1mm		
C = 206mm	D = 163mm	30, 50 = M8, M6		
	Th = 3xM8			

DSN3015			12V	1.8kW
VW Grp.				
	ØA = 82.5mm	B = 15mm		
C = 214mm	D = 164mm	30, 50 = M8, Plug		
	Th = 2xM12			

DSN3015			12V	1.8kW
VW Grp.				
	ØA = 82.5mm	B = 15mm		
C = 214mm	D = 164mm	30, 50 = M8, Plug		
	Th = 2xM12			

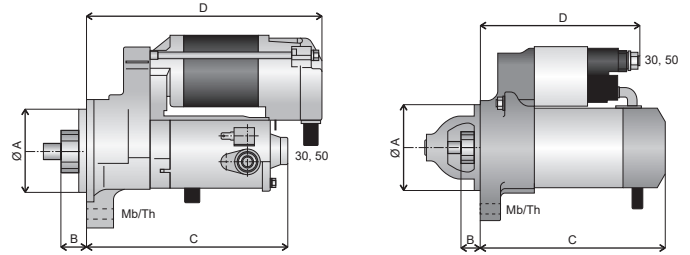

DSN3016		12V	2kW
VW Grp.			
10	ØA = 76.2mm	B = 52mm	
C = 178mm	D = 135mm	30, 50 = M8, Plug	
Mb = 3xØ9			

DSN3016		12V	2kW
VW Grp.			
10	ØA = 76.2mm	B = 52mm	
C = 178mm	D = 135mm	30, 50 = M8, Plug	
Mb = 3xØ9			

DSN3017		12V	2kW
OPEL			
10	ØA = 82.5mm	B = 18mm	
C = 193mm	D = 152mm	30, 50 = M8, M6	
Mb = 1xØ10.5	Th = 1xM12		

DSN3017		12V	2kW
OPEL			
10	ØA = 82.5mm	B = 18mm	
C = 193mm	D = 152mm	30, 50 = M8, M6	
Mb = 1xØ10.5	Th = 1xM12		

DSN3018		12V	2kW
FIAT			
9	ØA = 82mm	B = 9mm	
C = 193mm	D = 152mm	30, 50 = M8, M6	
Mb = 3xØ9			

DSN3018		12V	2kW
FIAT			
9	ØA = 82mm	B = 9mm	
C = 193mm	D = 152mm	30, 50 = M8, M6	
Mb = 3xØ9			

Starters & Alternators | Memo

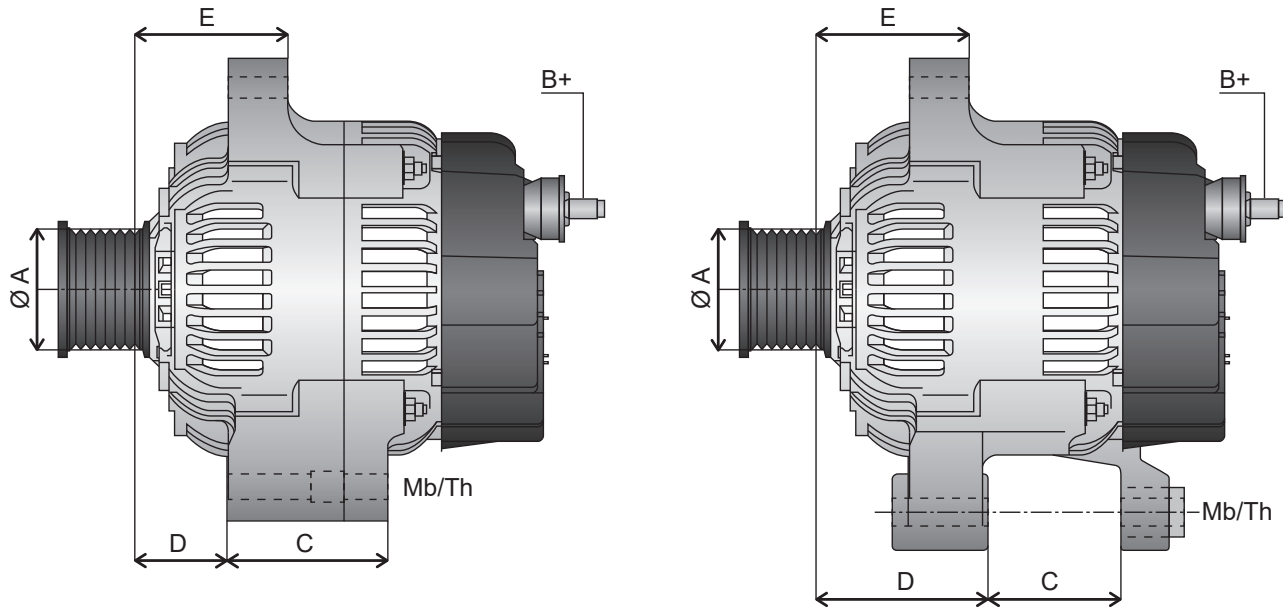
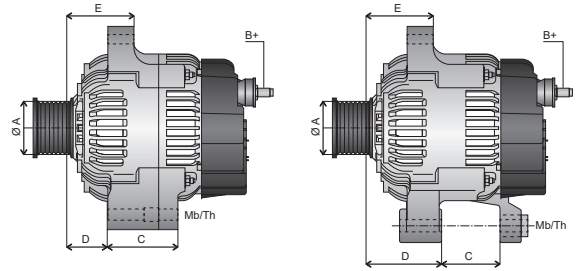

Photo guide Legend Alternators

	GB	DE	FR	ES	IT	SE	PL	RU
	Solid Alternator Pulley	Feste Generatorriemenscheibe	Poulie d'alternateur pleine	Polea de alternador maciza	Puleggia alternatore solida	Solid generatorremskiva	Stale koło pasowe alternatora	Шкив генератора цельный
	Overrunning Alternator Pulley (One-Way Clutch)	Generator-Freilaufriemenscheibe (Einwegkupplung)	Poulie à roue libre d'alternateur (Embrayage unidirectionnel)	Polea libre de alternador (embrague unidireccional)	Puleggia a ruota libera dell'alternatore (Frizione unidirezionale)	Frihjulremskiva (envägskoppling)	Wolne koło pasowe alternatora (ze sprzęgłem jednokierunkowym)	Шкив генератора с обгонной муфтой (Шкив генератора одностороннего вращения)
	Overrunning Alternator Decoupler	Generator-Freilaufentkoppler	Découpleur à roue libre d'alternateur	Desacoplador libre de alternador	Disaccoppiatore dell'alternatore	Frihjulskoppling	Sprzęgielko alternatora	Шкив генератора с обгонной разобщающей муфтой
	Alternator Coupling Shaft	Keilriemenscheibe	Arbre d'accouplement d'alternateur	Eje de acoplamiento del alternador	Albero accoppiamento alternatore	Axel till generatorkoppling	Alternator z końcówką łączeniową	Фланец вала генератора
	V-Belt Pulley	Keilriemenscheibe	Poulie à courroie trapézoïdale	Polea trapezoidal	Puleggia per cinghia a V	Kilremsskiva	Koło pasowe klinowe	Шкив для клинового ремня
	Poly V-Belt Pulley	Poly-V-Riemscheiben	Poulie à courroie striée	Polea Poly-V	Puleggia per cinghia Poly-V	Poly-V-remskiva	Polietylenowe koło pasowe klinowe	Шкив для поликлинового ремня
	Freewheel Poly V-Belt Pulley	Freilauf Poly-V-Riemscheiben	Poulie roue libre à courroie striée	Polea Poly-V de rueda libre	Puleggia a ruota libera per cinghia Poly-V	Poly-V-frihjulremskiva	Polietylenowe wolne koło pasowe klinowe	Шкив для поликлинового ремня свободного хода
	Mounting Bores	Befestigungsbohrung	Alésages de fixation	Taladros de fijación	Fori di montaggio	Fästhål	Liczba otworów do mocowania	Установочные отверстия
	Thread Bores	Gewindebohrungen	Alésages filetés	Taladros de fijación roscados	Fori filettati	Gångade hål	Liczba otworów gwintowanych	Диаметр резьбы
	May require new bracket: 4141A136	Evtl. neue Halterungen erforderlich: 4141A136	Peut nécessiter le nouveau support 4141A136	Puede necesitar un nuevo soporte: 4141A136	Potrebbe necessitare di una nuova staffa: 4141A136	Kan kräva nytt fäste: 4141A136	Może wymagać nowej tarczy: 4141A136	Может потребоваться новый кронштейн: 4141A136



DAN005		14V	65A
C = 81mm Mb = 3xØ8.2	D = 52mm	B+ M6, D+ M5, W M5 E = D	

DAN005		14V	65A
C = 81mm Mb = 3xØ8.2	D = 52mm	B+ M6, D+ M5, W M5 E = D	

DAN047		14V	70A
Poly-V 5 C = 62mm Mb = 2xØ8, 1xØ8.2	ØA = 60mm D = 35mm Th = 1xM8	B+ M6, D+ M5, W M5 E = D	

DAN047		14V	70A
Poly-V 5 C = 62mm Mb = 2xØ8, 1xØ8.2	ØA = 60mm D = 35mm Th = 1xM8	B+ M6, D+ M5, W M5 E = D	

DAN501		14V	105A
Poly-VF 6 C = 55mm Mb = 2xØ12.2, 1xØ10.8	ØA = 62mm D = 45mm	B+ M8, D+ M5 E = D	

DAN501		14V	105A
Poly-VF 6 C = 55mm Mb = 2xØ12.2, 1xØ10.8	ØA = 62mm D = 45mm	B+ M8, D+ M5 E = D	

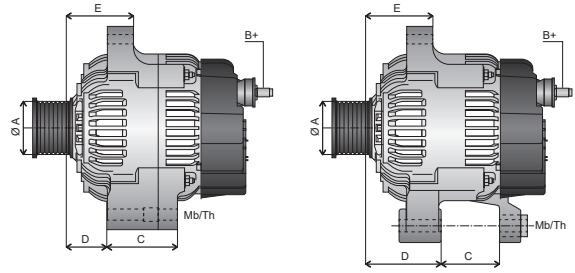

DAN502		14V	120A
FIAT			
Poly-VF 6	ØA = 62mm	B+ M8, D+ M5	
C = 55mm	D = 45mm	E = D	
Mb = 2xØ12.2, 1xØ10.8			

DAN502		14V	120A
FIAT			
Poly-VF 6	ØA = 62mm	B+ M8, D+ M5	
C = 55mm	D = 45mm	E = D	
Mb = 2xØ12.2, 1xØ10.8			

DAN504		14V	70A
Poly-V 5	ØA = 60mm	B+ M6, D+ M5, W M5	
C = 76mm	D = 33mm	E = D	
Mb = 1xØ8.2, 1xØ8	Th = 1xM8		

DAN504		14V	70A
Poly-V 5	ØA = 60mm	B+ M6, D+ M5, W M5	
C = 76mm	D = 33mm	E = D	
Mb = 1xØ8.2, 1xØ8	Th = 1xM8		

DAN506		14V	120A
Poly-VF 6	ØA = 62mm	B+ M8, D+ M5	
C = 61mm	D = 52mm	E = 58mm	
Mb = 2xØ12.2			

DAN506		14V	120A
Poly-VF 6	ØA = 62mm	B+ M8, D+ M5	
C = 61mm	D = 52mm	E = 58mm	
Mb = 2xØ12.2			

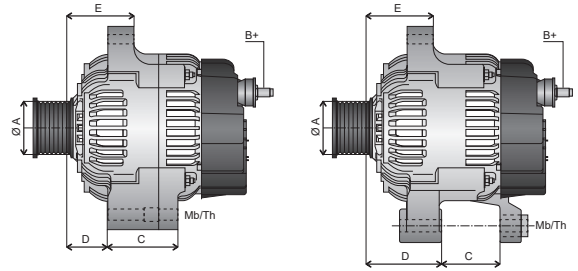

DAN509		14V	130A
Poly-VF 6 C = 61mm Mb = 2xØ12.2	ØA = 62mm D = 52mm	B+ M8, D+ M5, DFM M6 E = 58mm	

DAN509		14V	130A
Poly-VF 6 C = 61mm Mb = 2xØ12.2	ØA = 62mm D = 52mm	B+ M8, D+ M5, DFM M6 E = 58mm	

DAN510		14V	105A
Poly-VF 6 C = 61mm Mb = 2xØ12.2	ØA = 62mm D = 52mm	B+ M8, D+ M5 E = 58mm	

DAN510		14V	105A
Poly-VF 6 C = 61mm Mb = 2xØ12.2	ØA = 62mm D = 52mm	B+ M8, D+ M5 E = 58mm	

DAN513		14V	120A
Poly-VF 6 C = 61mm Mb = 2xØ12.2	ØA = 62mm D = 52mm	B+ M8, D+ M5 E = 58mm	

DAN513		14V	120A
Poly-VF 6 C = 61mm Mb = 2xØ12.2	ØA = 62mm D = 52mm	B+ M8, D+ M5 E = 58mm	

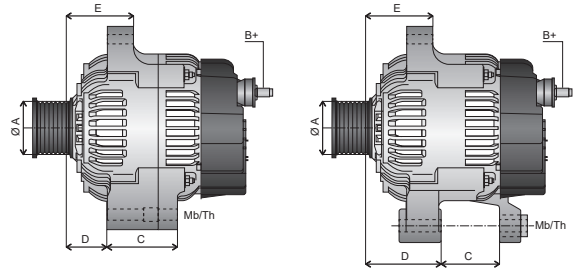

DAN515		14V	90A
Poly-V 6 C = 46mm Mb = 1xØ10.1, 1xØ10.6	ØA = 49mm D = 43mm Th = 2xM10	B+ M8, PL01 E = D	L DF

DAN515		14V	90A
Poly-V 6 C = 46mm Mb = 1xØ10.1, 1xØ10.6	ØA = 49mm D = 43mm Th = 2xM10	B+ M8, PL01 E = D	L DF

DAN517		14V	70A
Poly-V 5 C = 50mm Mb = 3xØ8.5	ØA = 54mm D = 17mm	B+ M8, D+ M5 E = 67mm	

DAN517		14V	70A
Poly-V 5 C = 50mm Mb = 3xØ8.5	ØA = 54mm D = 17mm	B+ M8, D+ M5 E = 67mm	

DAN519		14V	90A
Poly-V 5 C = 50mm Mb = 3xØ8.5	ØA = 54mm D = 17mm	B+ M8, D+ M5 E = 67mm	

DAN519		14V	90A
Poly-V 5 C = 50mm Mb = 3xØ8.5	ØA = 54mm D = 17mm	B+ M8, D+ M5 E = 67mm	

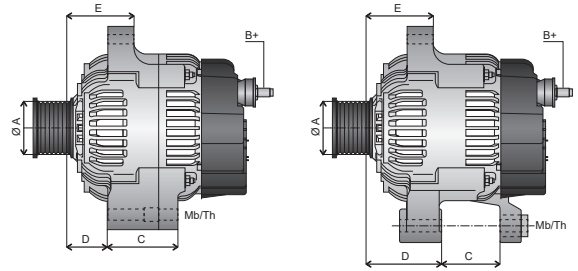

DAN520		14V	90A
Poly-VF 6 C = 55mm Mb = 2xØ12.2, 1xØ10.8	ØA = 62mm D = 45mm	B+ M8, D+ M5 E = D	

DAN520		14V	90A
Poly-VF 6 C = 55mm Mb = 2xØ12.2, 1xØ10.8	ØA = 62mm D = 45mm	B+ M8, D+ M5 E = D	

DAN562		14V	90A
Poly-V 6 C = 62mm Mb = 2xØ8.2	ØA = 48.3mm D = 33mm Th = 2xM8	B+ M6, PL10 E = D	

DAN562		14V	90A
Poly-V 6 C = 62mm Mb = 2xØ8.2	ØA = 48.3mm D = 33mm Th = 2xM8	B+ M6, PL10 E = D	

DAN582		14V	105A
 C = 52mm Mb = 1xØ9, 1xØ8.5	ØA = 78mm D = 78mm Th = 2xM8	B+ M8, PL10 E = D	

DAN582		14V	105A
 C = 52mm Mb = 1xØ9, 1xØ8.5	ØA = 78mm D = 78mm Th = 2xM8	B+ M8, PL10 E = D	

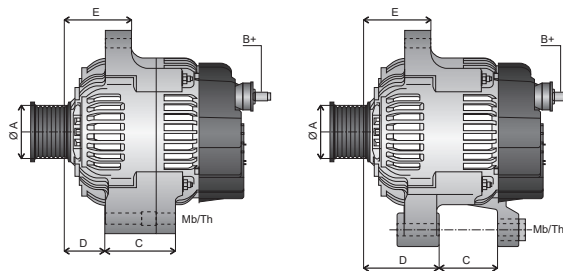

DAN583		14V	70A
Poly-VF 6	ØA = 54mm	B+ M8, PL04	
C = 55mm	D = 42mm	E = 67mm	
Mb = 3xØ8.5			

DAN583		14V	70A
Poly-VF 6	ØA = 54mm	B+ M8, PL04	
C = 55mm	D = 42mm	E = 67mm	
Mb = 3xØ8.5			

DAN584		14V	105A
Poly-VF 6	ØA = 54mm	B+ M8, PL04	
C = 55mm	D = 42mm	E = 67mm	
Mb = 3xØ8.5			

DAN584		14V	105A
Poly-VF 6	ØA = 54mm	B+ M8, PL04	
C = 55mm	D = 42mm	E = 67mm	
Mb = 3xØ8.5			

DAN585		14V	120A
Poly-VF 6	ØA = 54mm	B+ M8, PL04	
C = 55mm	D = 42mm	E = 67mm	
Mb = 3xØ8.5			

DAN585		14V	120A
Poly-VF 6	ØA = 54mm	B+ M8, PL04	
C = 55mm	D = 42mm	E = 67mm	
Mb = 3xØ8.5			

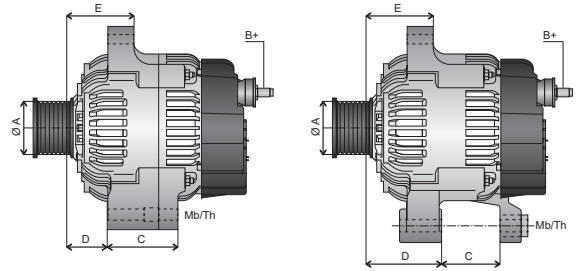

DAN588		14V	105A
Poly-V 6 C = 50mm Mb = 2xØ12.5, 1xØ10.3	ØA = 48.3mm D = 11mm	B+ M6, PL10 E = 65mm	

DAN588		14V	105A
Poly-V 6 C = 50mm Mb = 2xØ12.5, 1xØ10.3	ØA = 48.3mm D = 11mm	B+ M6, PL10 E = 65mm	

DAN599		14V	105A
Poly-V 5 C = 50mm Mb = 3xØ8.5	ØA = 54mm D = 17mm	B+ M8, D+ M5 E = 67mm	

DAN599		14V	105A
Poly-V 5 C = 50mm Mb = 3xØ8.5	ØA = 54mm D = 17mm	B+ M8, D+ M5 E = 67mm	

DAN615		14V	65A
Poly-V 5 C = 63mm Mb = 2xØ12.2, 1xØ11	ØA = 65mm D = 56mm	B+ M6, D+ 6.3x0.8 E = 67mm	

DAN615		14V	65A
Poly-V 5 C = 63mm Mb = 2xØ12.2, 1xØ11	ØA = 65mm D = 56mm	B+ M6, D+ 6.3x0.8 E = 67mm	

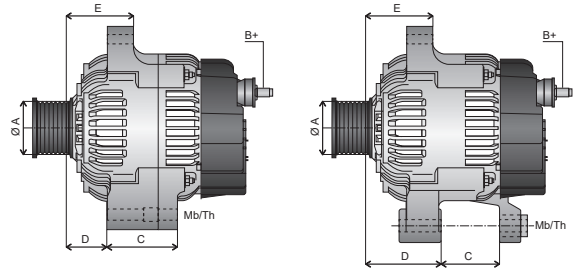

DAN628		14V	85A
Poly-V 6 C = 82mm Mb = 2xØ12.2, 1xØ11	ØA = 62mm D = 41mm	B+ M8, D+ M5 E = D	

DAN628		14V	85A
Poly-V 6 C = 82mm Mb = 2xØ12.2, 1xØ11	ØA = 62mm D = 41mm	B+ M8, D+ M5 E = D	

DAN629		14V	90A
Poly-V 4 C = 84mm Mb = 2xØ12.2, 1x(11x44)	ØA = 60mm D = 44mm	B+ M8, D+ M5	

DAN629		14V	90A
Poly-V 4 C = 84mm Mb = 2xØ12.2, 1x(11x44)	ØA = 60mm D = 44mm	B+ M8, D+ M5	

DAN630		14V	65A
Poly-V 4 C = 32mm Mb = 2xØ10.2, 1x(11x44)	ØA = 60mm D = 30mm	B+ M8, D+ M5 E = 164mm	

DAN630		14V	65A
Poly-V 4 C = 32mm Mb = 2xØ10.2, 1x(11x44)	ØA = 60mm D = 30mm	B+ M8, D+ M5 E = 164mm	

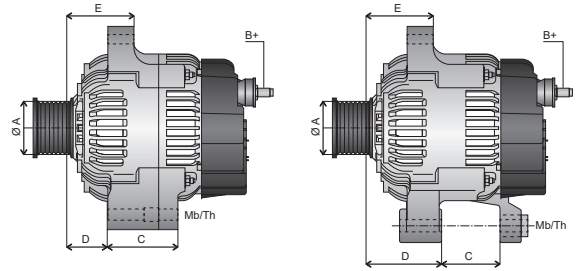

DAN631		14V	90A
Poly-V 4 C = 33mm Mb = 1xØ10.3, 1xØ8.6, 1x(11x39)	ØA = 60mm D = 22mm	B+ M8, D+ M5 E = 104mm	

DAN631		14V	90A
Poly-V 4 C = 33mm Mb = 1xØ10.3, 1xØ8.6, 1x(11x39)	ØA = 60mm D = 22mm	B+ M8, D+ M5 E = 104mm	



DAN632		14V	100A
Poly-V 7 C = 55mm Mb = 2xØ12.2, 1xØ10.8	ØA = 62mm D = 41mm	B+ M8, D+ M5 E = D	



DAN632		14V	100A
Poly-V 7 C = 55mm Mb = 2xØ12.2, 1xØ10.8	ØA = 62mm D = 41mm	B+ M8, D+ M5 E = D	

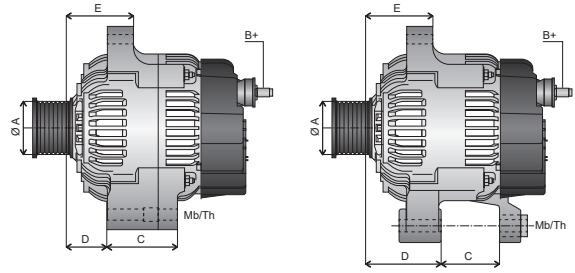

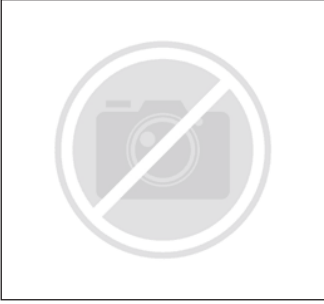
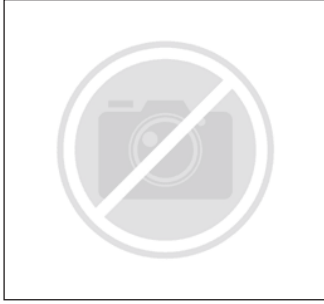
DAN640		14V	65A
Poly-VF 6 C = 55mm Mb = 2xØ12.2, 1xØ10.8	ØA = 62mm D = 45mm	B+ M8, D+ M5 E = D	

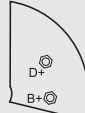

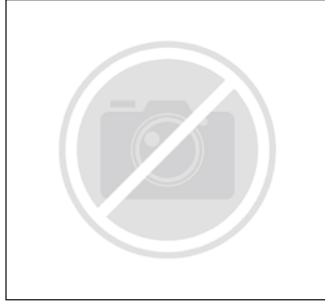
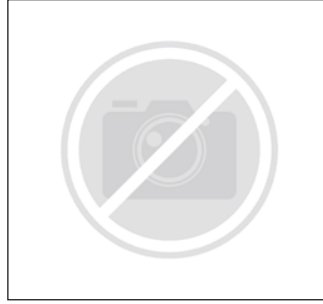
DAN640		14V	65A
Poly-VF 6 C = 55mm Mb = 2xØ12.2, 1xØ10.8	ØA = 62mm D = 45mm	B+ M8, D+ M5 E = D	

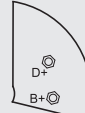

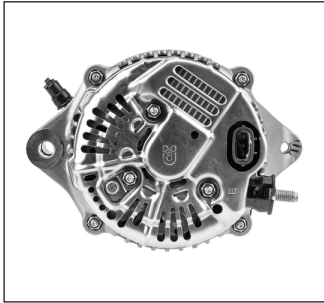

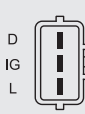

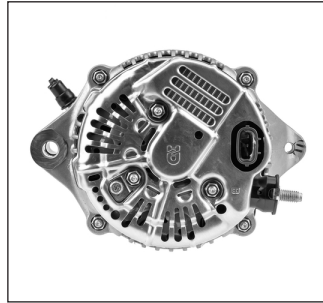



DAN641		14V	120A
 			
 Poly-V 6 C = 55mm Mb = 2xØ12.2, 1xØ10.8	ØA = 62mm D = 45mm	B+ M8, D+ M5 E = D	

DAN641		14V	120A
 			
 Poly-V 6 C = 55mm Mb = 2xØ12.2, 1xØ10.8	ØA = 62mm D = 45mm	B+ M8, D+ M5 E = D	

DAN670		14V	120A
 			
 Poly-V 7 C = 70mm Mb = 1xØ10.2	ØA = 55mm D = 74mm Th = 1xM8	B+ M8, PL07 E = 66mm	

DAN670		14V	120A
 			
 Poly-V 7 C = 70mm Mb = 1xØ10.2	ØA = 55mm D = 74mm Th = 1xM8	B+ M8, PL07 E = 66mm	

DAN671		14V	120A
 			
 Poly-V 5 C = 58mm Mb = 1xØ10.2	ØA = 50.5mm D = 32mm Th = 1xM8	B+ M8, PL13 E = 54mm	

DAN671		14V	120A
 			
 Poly-V 5 C = 58mm Mb = 1xØ10.2	ØA = 50.5mm D = 32mm Th = 1xM8	B+ M8, PL13 E = 54mm	

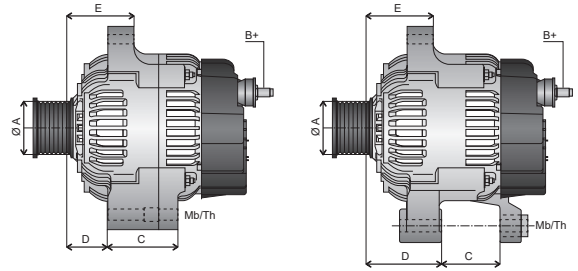

DAN672		14V	120A
Poly-V 7 C = 58mm Mb = 1xØ10.2, 1xØ8.5	ØA = 47.7mm D = 32mm	B+ M8, PL07 E = 54mm	

DAN672		14V	120A
Poly-V 7 C = 58mm Mb = 1xØ10.2, 1xØ8.5	ØA = 47.7mm D = 32mm	B+ M8, PL07 E = 54mm	

DAN673		14V	90A
Poly-V 5 C = 58mm Mb = 1xØ10.2	ØA = 48mm D = 32mm Th = 1xM8	B+ M6, PL07 E = 54mm	

DAN673		14V	90A
Poly-V 5 C = 58mm Mb = 1xØ10.2	ØA = 48mm D = 32mm Th = 1xM8	B+ M6, PL07 E = 54mm	

DAN674		14V	105A
Poly-V 5 C = 58mm Mb = 2xØ10.2	ØA = 48mm D = 32mm	B+ M6, PL07 E = 63mm	

DAN674		14V	105A
Poly-V 5 C = 58mm Mb = 2xØ10.2	ØA = 48mm D = 32mm	B+ M6, PL07 E = 63mm	

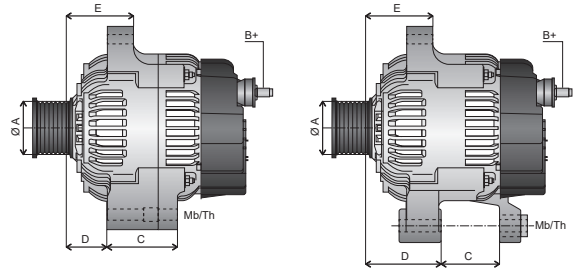

DAN930		14V	150A
Poly-VF 6 C = 46mm Mb = 1xØ10.1, 1xØ10.6	ØA = 54.3mm D = 43mm Th = 2xM10	B+ M8, PL10 E = D	

DAN930		14V	150A
Poly-VF 6 C = 46mm Mb = 1xØ10.1, 1xØ10.6	ØA = 54.3mm D = 43mm Th = 2xM10	B+ M8, PL10 E = D	

DAN931		14V	150A
Poly-V 6 C = 69mm Mb = 1xØ8.2, 1xØ9.2, 1x(8.2x9.2)	ØA = 49mm D = 75mm	B+ M8, PL10 E = 40mm	

DAN931		14V	150A
Poly-V 6 C = 69mm Mb = 1xØ8.2, 1xØ9.2, 1x(8.2x9.2)	ØA = 49mm D = 75mm	B+ M8, PL10 E = 40mm	

DAN932		14V	150A
Poly-V 6 C = 52mm Mb = 2xØ8.2	ØA = 78mm D = 78mm Th = 2xM8	B+ M8, PL10 E = D	

DAN932		14V	150A
Poly-V 6 C = 52mm Mb = 2xØ8.2	ØA = 78mm D = 78mm Th = 2xM8	B+ M8, PL10 E = D	

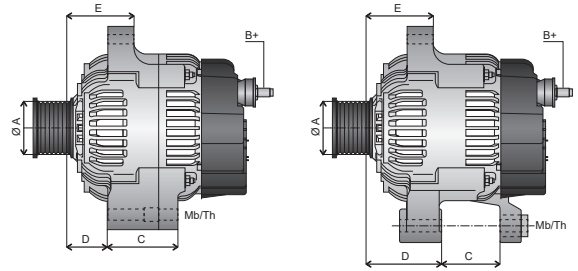

DAN933		14V	150A
Poly-VF 6 C = 52mm Mb = 2xØ8.2	ØA = 54.3mm D = 42mm Th = 2xM8	B+ M8, PL10 E = D	

DAN933		14V	150A
Poly-VF 6 C = 52mm Mb = 2xØ8.2	ØA = 54.3mm D = 42mm Th = 2xM8	B+ M8, PL10 E = D	

DAN934		14V	150A
Poly-VF 6 C = 69mm Mb = 1xØ8.2, 1xØ9.2, 1x(8.2x9.2)	ØA = 49mm D = 75mm	B+ M8, PL10 E = 40mm	

DAN934		14V	150A
Poly-VF 6 C = 69mm Mb = 1xØ8.2, 1xØ9.2, 1x(8.2x9.2)	ØA = 49mm D = 75mm	B+ M8, PL10 E = 40mm	

DAN935		14V	150A
Poly-VF 6 C = 65mm Mb = 1xØ11.1, 1xØ12.2, 1xØ12.5	ØA = 55mm D = 26mm	B+ M8, PL01 E = D	

DAN935		14V	150A
Poly-VF 6 C = 65mm Mb = 1xØ11.1, 1xØ12.2, 1xØ12.5	ØA = 55mm D = 26mm	B+ M8, PL01 E = D	

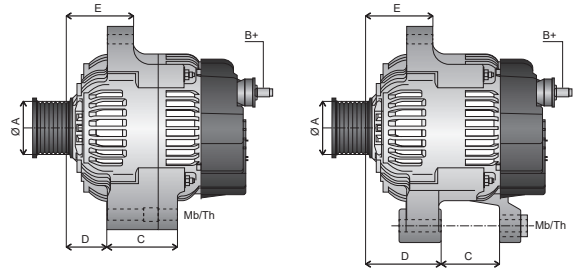

DAN936		14V	150A
Poly-VF 5 C = 65mm Mb = 1xØ11.1, 1xØ12.2, 1xØ12.5	ØA = 61.5mm D = 28mm	B+ M8, PL01 E = D	

DAN936		14V	150A
Poly-VF 5 C = 65mm Mb = 1xØ11.1, 1xØ12.2, 1xØ12.5	ØA = 61.5mm D = 28mm	B+ M8, PL01 E = D	

DAN938		14V	100A
Poly-VF 7 C = 71mm Mb = 1xØ10.4, 1xØ8.4, 1x(11.2x8.8)	ØA = 58mm D = 24mm	B+ M6, PL17 E = 55mm	

DAN938		14V	100A
Poly-VF 7 C = 71mm Mb = 1xØ10.4, 1xØ8.4, 1x(11.2x8.8)	ØA = 58mm D = 24mm	B+ M6, PL17 E = 55mm	

DAN939		14V	120A
V 1 C = 53mm Mb = 1xØ10.2	ØA = 99mm D = 43mm Th = 1xM8	B+ M6, PL16 E = 72mm	

DAN939		14V	120A
V 1 C = 53mm Mb = 1xØ10.2	ØA = 99mm D = 43mm Th = 1xM8	B+ M6, PL16 E = 72mm	

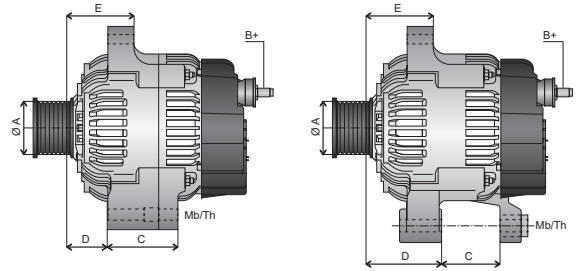

DAN943		14V	70A
Poly-V 6 C = 40mm Mb = 1xØ11	ØA = 55mm D = 34mm Th = 1xM10, 1xM8	B+ M6, PL05 E = 56mm	

DAN943		14V	70A
Poly-V 6 C = 40mm Mb = 1xØ11	ØA = 55mm D = 34mm Th = 1xM10, 1xM8	B+ M6, PL05 E = 56mm	

DAN944		14V	80A
Poly-V 6 C = 40mm Mb = 1xØ11	ØA = 55mm D = 34mm Th = 1xM10, 1xM8	B+ M6, PL05 E = 56mm	

DAN944		14V	80A
Poly-V 6 C = 40mm Mb = 1xØ11	ØA = 55mm D = 34mm Th = 1xM10, 1xM8	B+ M6, PL05 E = 56mm	

DAN945		14V	130A
TOYOTA			
Poly-VF 5 C = 53mm Mb = 1xØ10.2, 1xØ9.7	ØA = 58mm D = 41mm	B+ M6, PL16 E = 49mm	

DAN945		14V	130A
TOYOTA			
Poly-VF 5 C = 53mm Mb = 1xØ10.2, 1xØ9.7	ØA = 58mm D = 41mm	B+ M6, PL16 E = 49mm	

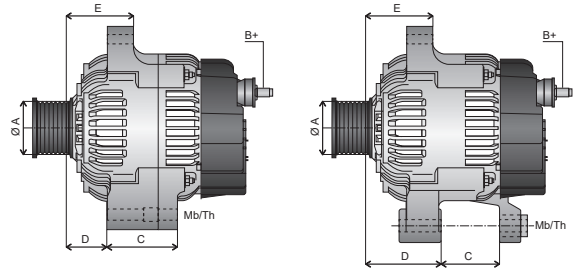

DAN948		14V	80A
Poly-V 6	ØA = 55mm	B+ M6, PL05	
C = 40mm	D = 34mm	E = 56mm	
Mb = 1xØ11	Th = 1xM10, 1xM8		

DAN948		14V	80A
Poly-V 6	ØA = 55mm	B+ M6, PL05	
C = 40mm	D = 34mm	E = 56mm	
Mb = 1xØ11	Th = 1xM10, 1xM8		

DAN950		14V	90A
Poly-VF 5	ØA = 60mm	B+ M6, PL08	
C = 41mm	D = 32mm	E = 46mm	
Mb = 1xØ11	Th = 1xM10, 1xM8		

DAN950		14V	90A
Poly-VF 5	ØA = 60mm	B+ M6, PL08	
C = 41mm	D = 32mm	E = 46mm	
Mb = 1xØ11	Th = 1xM10, 1xM8		

DAN951		14V	90A
Poly-V 7	ØA = 55mm	B+ M6, PL05	
C = 45mm	D = 36mm	E = 72mm	
Mb = 1xØ11	Th = 1xM10, 1xM8		

DAN951		14V	90A
Poly-V 7	ØA = 55mm	B+ M6, PL05	
C = 45mm	D = 36mm	E = 72mm	
Mb = 1xØ11	Th = 1xM10, 1xM8		

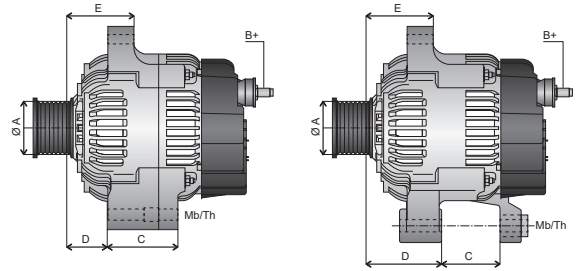

DAN952		14V	100A
Poly-V 7	ØA = 60mm	B+ M6, PL16	
C = 45mm	D = 36mm	E = 74mm	
Mb = 1xØ11	Th = 1xM10, 1xM8		

DAN952		14V	100A
Poly-V 7	ØA = 60mm	B+ M6, PL16	
C = 45mm	D = 36mm	E = 74mm	
Mb = 1xØ11	Th = 1xM10, 1xM8		

DAN955		14V	80A
Poly-V 5	ØA = 55mm	B+ M6, PL05	
C = 58mm	D = 32mm	E = 54mm	
Mb = 1xØ10.2	Th = 1xM8		

DAN955		14V	80A
Poly-V 5	ØA = 55mm	B+ M6, PL05	
C = 58mm	D = 32mm	E = 54mm	
Mb = 1xØ10.2	Th = 1xM8		

DAN959		14V	80A
Poly-V 4	ØA = 57.5mm	B+ M6, PL08	
C = 41mm	D = 34mm	E = 52mm	
Mb = 1xØ11	Th = 1xM10, 1xM8		

DAN959		14V	80A
Poly-V 4	ØA = 57.5mm	B+ M6, PL08	
C = 41mm	D = 34mm	E = 52mm	
Mb = 1xØ11	Th = 1xM10, 1xM8		

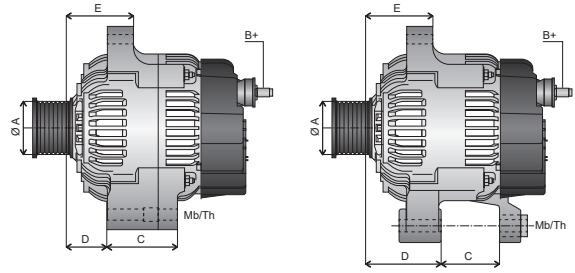

DAN960		14V	70A
Poly-V 4	$\text{ØA} = 55\text{mm}$	B+ M6, PL08	
C = 39mm	D = 48mm	E = 62mm	
Mb = 2xØ10.2	Th = 1xM8		

DAN960		14V	70A
Poly-V 4	$\text{ØA} = 55\text{mm}$	B+ M6, PL08	
C = 39mm	D = 48mm	E = 62mm	
Mb = 2xØ10.2	Th = 1xM8		

DAN961		14V	90A
Poly-V 4	$\text{ØA} = 55\text{mm}$	B+ M6, PL08	
C = 39mm	D = 48mm	E = 62mm	
Mb = 2xØ10.2	Th = 1xM8		

DAN961		14V	90A
Poly-V 4	$\text{ØA} = 55\text{mm}$	B+ M6, PL08	
C = 39mm	D = 48mm	E = 62mm	
Mb = 2xØ10.2	Th = 1xM8		

DAN962		14V	70A
Poly-V 6	$\text{ØA} = 55\text{mm}$	B+ M6, PL08	
C = 39mm	D = 48mm	E = 62mm	
Mb = 2xØ10.2	Th = 1xM8		

DAN962		14V	70A
Poly-V 6	$\text{ØA} = 55\text{mm}$	B+ M6, PL08	
C = 39mm	D = 48mm	E = 62mm	
Mb = 2xØ10.2	Th = 1xM8		

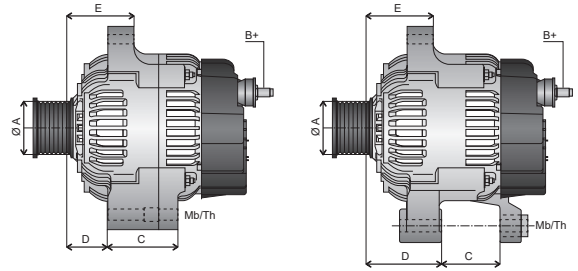

DAN964		14V	70A
Poly-VF 5 C = 41mm Mb = 1xØ11	ØA = 60mm D = 32mm Th = 1xM10, 1xM8	B+ M6, PL08 E = 52mm	

DAN964		14V	70A
Poly-VF 5 C = 41mm Mb = 1xØ11	ØA = 60mm D = 32mm Th = 1xM10, 1xM8	B+ M6, PL08 E = 52mm	

DAN966		14V	70A
Poly-V 4 C = 41mm Mb = 1xØ11	ØA = 57.5mm D = 34mm Th = 1xM10, 1xM8	B+ M6, PL08 E = 52mm	

DAN966		14V	70A
Poly-V 4 C = 41mm Mb = 1xØ11	ØA = 57.5mm D = 34mm Th = 1xM10, 1xM8	B+ M6, PL08 E = 52mm	

DAN968		14V	40A
V 1 C = 24mm Mb = 1xØ10.2	ØA = 63mm D = 20mm Th = 1xM8	B+ M6, PL02 E = 62mm	

DAN968		14V	40A
V 1 C = 24mm Mb = 1xØ10.2	ØA = 63mm D = 20mm Th = 1xM8	B+ M6, PL02 E = 62mm	

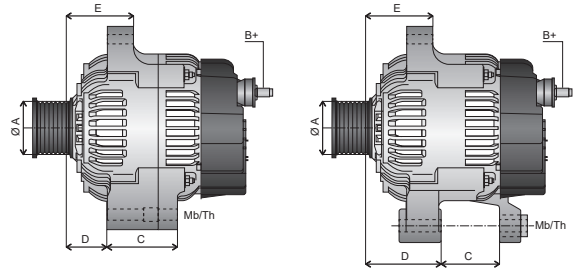

DAN969		14V	60A
Poly-V 4	ØA = 52.5mm	B+ M6, PL13	
C = 58mm	D = 32mm	E = 48mm	
Mb = 1xØ10.2	Th = 1xM8		

DAN969		14V	60A
Poly-V 4	ØA = 52.5mm	B+ M6, PL13	
C = 58mm	D = 32mm	E = 48mm	
Mb = 1xØ10.2	Th = 1xM8		

DAN970		14V	70A
Poly-V 4	ØA = 60mm	B+ M6, PL06	
C = 58mm	D = 32mm	E = 48mm	
Mb = 1xØ10.2	Th = 1xM8		

DAN970		14V	70A
Poly-V 4	ØA = 60mm	B+ M6, PL06	
C = 58mm	D = 32mm	E = 48mm	
Mb = 1xØ10.2	Th = 1xM8		

DAN971		14V	60A
Poly-V 4	ØA = 52.5mm	B+ M6, PL07	
C = 58mm	D = 32mm	E = 48mm	
Mb = 1xØ10.2	Th = 1xM8		

DAN971		14V	60A
Poly-V 4	ØA = 52.5mm	B+ M6, PL07	
C = 58mm	D = 32mm	E = 48mm	
Mb = 1xØ10.2	Th = 1xM8		

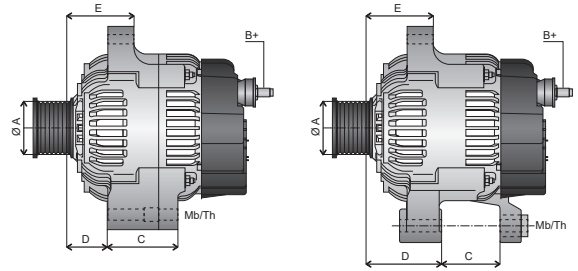

DAN972		14V	70A
Poly-V 4	ØA = 57.5mm	B+ M6, PL06	
C = 58mm	D = 32mm	E = 48mm	
Mb = 1xØ10.2	Th = 1xM8		

DAN972		14V	70A
Poly-V 4	ØA = 57.5mm	B+ M6, PL06	
C = 58mm	D = 32mm	E = 48mm	
Mb = 1xØ10.2	Th = 1xM8		

DAN973		14V	60A
Poly-V 4	ØA = 52.5mm	B+ M6, PL02	
C = 29mm	D = 19mm	E = 39mm	
Mb = 1xØ10.2	Th = 1xM8		

DAN973		14V	60A
Poly-V 4	ØA = 52.5mm	B+ M6, PL02	
C = 29mm	D = 19mm	E = 39mm	
Mb = 1xØ10.2	Th = 1xM8		

DAN974		14V	60A
Poly-V 4	ØA = 57.5mm	B+ M6, PL02	
C = 29mm	D = 19mm	E = 39mm	
Mb = 1xØ10.2	Th = 1xM8		

DAN974		14V	60A
Poly-V 4	ØA = 57.5mm	B+ M6, PL02	
C = 29mm	D = 19mm	E = 39mm	
Mb = 1xØ10.2	Th = 1xM8		

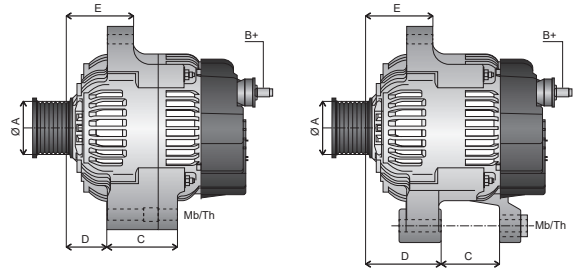

DAN975		14V	65A
Poly-V 4	ØA = 57.5mm	B+ M6, PL06	
C = 29mm	D = 19mm	E = 39mm	
Mb = 1xØ10.2	Th = 1xM8		

DAN975		14V	65A
Poly-V 4	ØA = 57.5mm	B+ M6, PL06	
C = 29mm	D = 19mm	E = 39mm	
Mb = 1xØ10.2	Th = 1xM8		

DAN976		14V	70A
Poly-V 4	ØA = 55mm	B+ M6, PL07	
C = 39mm	D = 48mm	E = 56mm	
Mb = 2xØ10.2	Th = 1xM8		

DAN976		14V	70A
Poly-V 4	ØA = 55mm	B+ M6, PL07	
C = 39mm	D = 48mm	E = 56mm	
Mb = 2xØ10.2	Th = 1xM8		

DAN978		14V	70A
Poly-V 4	ØA = 55mm	B+ M6, PL07	
C = 39mm	D = 48mm	E = 56mm	
Mb = 2xØ10.2	Th = 1xM8		

DAN978		14V	70A
Poly-V 4	ØA = 55mm	B+ M6, PL07	
C = 39mm	D = 48mm	E = 56mm	
Mb = 2xØ10.2	Th = 1xM8		

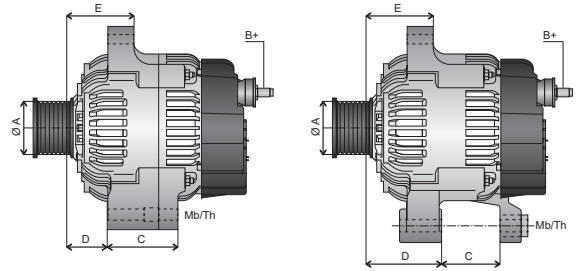

DAN979		14V	80A
Poly-V 6 C = 39mm Mb = 1xØ11, 1xØ10	ØA = 55mm D = 48mm Th = 1xM8	B+ M6, PL06 E = 56mm	

DAN979		14V	80A
Poly-V 6 C = 39mm Mb = 1xØ11, 1xØ10	ØA = 55mm D = 48mm Th = 1xM8	B+ M6, PL06 E = 56mm	

DAN980		14V	80A
Poly-V 4 C = 39mm Mb = 1xØ11, 1xØ10	ØA = 55mm D = 48mm Th = 1xM8	B+ M6, PL06 E = 56mm	

DAN980		14V	80A
Poly-V 4 C = 39mm Mb = 1xØ11, 1xØ10	ØA = 55mm D = 48mm Th = 1xM8	B+ M6, PL06 E = 56mm	

DAN981		14V	130A
Poly-VF 7 C = 41mm Mb = 1xØ11	ØA = 60mm D = 32mm Th = 3xM8, 1xM10	B+ M8, PL15 E = 54mm	

DAN981		14V	130A
Poly-VF 7 C = 41mm Mb = 1xØ11	ØA = 60mm D = 32mm Th = 3xM8, 1xM10	B+ M8, PL15 E = 54mm	

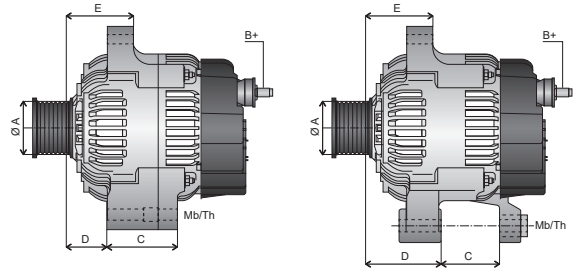

DAN985		14V	105A
Poly-VF 7 C = 44/54mm Mb = 1xØ9, 2xØ8.7	ØA = 70mm D = 37mm Th = 1xM8	B+ M8, PL14 E = D	

DAN985		14V	105A
Poly-VF 7 C = 44/54mm Mb = 1xØ9, 2xØ8.7	ØA = 70mm D = 37mm Th = 1xM8	B+ M8, PL14 E = D	

DAN986		14V	150A
Poly-V 6 C = 47mm Mb = 1xØ10.2, 1xØ12.8, 1x(11.5x14.2)	ØA = 53.8mm D = 29mm	B+ M8, PL10 E = 73mm	

DAN986		14V	150A
Poly-V 6 C = 47mm Mb = 1xØ10.2, 1xØ12.8, 1x(11.5x14.2)	ØA = 53.8mm D = 29mm	B+ M8, PL10 E = 73mm	

DAN987		14V	150A
Poly-VF 8 C = 47mm Mb = 1xØ10.2, 1xØ12.8, 1x(11.5x14.2)	ØA = 57.5mm D = 22mm	B+ M8, PL09 E = 66mm	

DAN987		14V	150A
Poly-VF 8 C = 47mm Mb = 1xØ10.2, 1xØ12.8, 1x(11.5x14.2)	ØA = 57.5mm D = 22mm	B+ M8, PL09 E = 66mm	

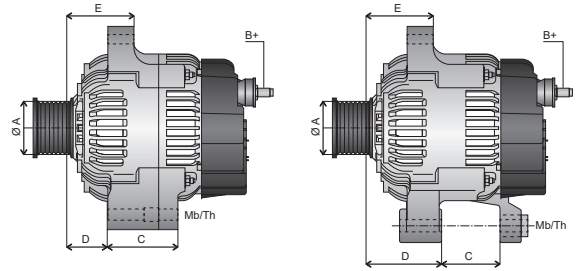

DAN988		14V	150A
Poly-VF 8 C = 47mm Mb = 1xØ10.2, 1xØ12.8, 1x(11.5x14.2)	ØA = 57.5mm D = 22mm	B+ M8, PL10 E = 66mm	

DAN988		14V	150A
Poly-VF 8 C = 47mm Mb = 1xØ10.2, 1xØ12.8, 1x(11.5x14.2)	ØA = 57.5mm D = 22mm	B+ M8, PL10 E = 66mm	

DAN989		14V	150A
Poly-V 8 C = 47mm Mb = 1xØ10.2, 1xØ12.8, 1x(11.5x14.2)	ØA = 57.5mm D = 22mm	B+ M8, PL09 E = 66mm	

DAN989		14V	150A
Poly-V 8 C = 47mm Mb = 1xØ10.2, 1xØ12.8, 1x(11.5x14.2)	ØA = 57.5mm D = 22mm	B+ M8, PL09 E = 66mm	

DAN990		14V	150A
Poly-V 6 C = 47mm Mb = 1xØ10.2, 1xØ12.8, 1x(11.5x14.2)	ØA = 57.5mm D = 22mm	B+ M8, PL10 E = 66mm	

DAN990		14V	150A
Poly-V 6 C = 47mm Mb = 1xØ10.2, 1xØ12.8, 1x(11.5x14.2)	ØA = 57.5mm D = 22mm	B+ M8, PL10 E = 66mm	

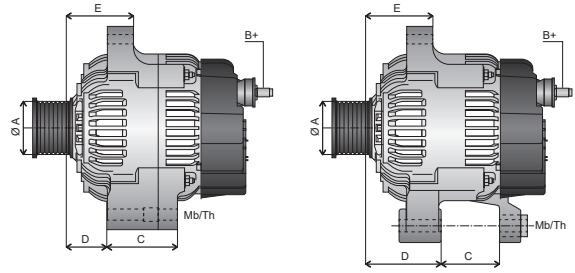

DAN991		14V	150A
Poly-V 6 C = 47mm Mb = 1xØ10.2, 1xØ12.8, 1x(11.5x14.2)	ØA = 53.8mm D = 29mm	B+ M8, PL09 E = 73mm	

DAN991		14V	150A
Poly-V 6 C = 47mm Mb = 1xØ10.2, 1xØ12.8, 1x(11.5x14.2)	ØA = 53.8mm D = 29mm	B+ M8, PL09 E = 73mm	

DAN993		14V	120A
Poly-VF 5 C = 50mm Mb = 3xØ8.5	ØA = 54mm D = 17mm	B+ M8, D+ M5 E = 67mm	

DAN993		14V	120A
Poly-VF 5 C = 50mm Mb = 3xØ8.5	ØA = 54mm D = 17mm	B+ M8, D+ M5 E = 67mm	

DAN994		14V	100A
Poly-VF 6 C = 61mm Mb = 2xØ12.2	ØA = 54mm D = 52mm	B+ M8, D+ M5 E = 58mm	

DAN994		14V	100A
Poly-VF 6 C = 61mm Mb = 2xØ12.2	ØA = 54mm D = 52mm	B+ M8, D+ M5 E = 58mm	

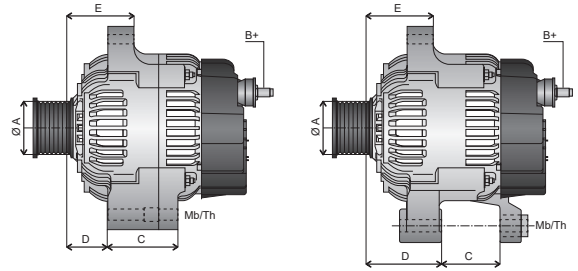

DAN995		14V	120A
Poly-VF 6 C = 61mm Mb = 2xØ12.2	ØA = 54mm D = 52mm	B+ M8, D+ M5 E = 58mm	

DAN995		14V	120A
Poly-VF 6 C = 61mm Mb = 2xØ12.2	ØA = 54mm D = 52mm	B+ M8, D+ M5 E = 58mm	

DAN996		14V	90A
Poly-VF 6 C = 55mm Mb = 3xØ8.5	ØA = 54mm D = 42mm	B+ M8, D+ M5 E = 67mm	

DAN996		14V	90A
Poly-VF 6 C = 55mm Mb = 3xØ8.5	ØA = 54mm D = 42mm	B+ M8, D+ M5 E = 67mm	

DAN997		14V	120A
Poly-VF 6 C = 55mm Mb = 3xØ8.5	ØA = 54mm D = 42mm	B+ M8, D+ M5 E = 67mm	

DAN997		14V	120A
Poly-VF 6 C = 55mm Mb = 3xØ8.5	ØA = 54mm D = 42mm	B+ M8, D+ M5 E = 67mm	

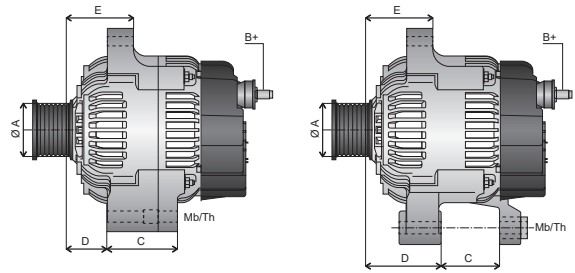

DAN998		14V	70A
Poly-V 4 C = 32mm Mb = 2xØ10.2, 1x(11x44)	ØA = 54mm D = 36mm	B+ M8, D+ M5 E = 171mm	

DAN998		14V	70A
Poly-V 4 C = 32mm Mb = 2xØ10.2, 1x(11x44)	ØA = 54mm D = 36mm	B+ M8, D+ M5 E = 171mm	

DAN999		14V	120A
Poly-V 5 C = 50mm Mb = 3xØ8.5	ØA = 54mm D = 17mm	B+ M8, D+ M5 E = 67mm	

DAN999		14V	120A
Poly-V 5 C = 50mm Mb = 3xØ8.5	ØA = 54mm D = 17mm	B+ M8, D+ M5 E = 67mm	

DAN1000		14V	120A
Poly-VF 6 C = 61mm Mb = 2xØ12.2	ØA = 56mm D = 52mm	B+ M8, D+ M5 E = 58mm	

DAN1000		14V	120A
Poly-VF 6 C = 61mm Mb = 2xØ12.2	ØA = 56mm D = 52mm	B+ M8, D+ M5 E = 58mm	

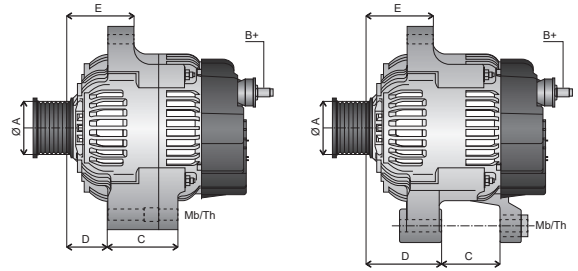

DAN1001		14V	105A
Poly-V 6 C = 55mm Mb = 3xØ8.5	ØA = 54mm D = 42mm	B+ M8, D+ M5 E = 67mm	

DAN1001		14V	105A
Poly-V 6 C = 55mm Mb = 3xØ8.5	ØA = 54mm D = 42mm	B+ M8, D+ M5 E = 67mm	

DAN1002		14V	90A
Poly-VF 6 C = 55mm Mb = 3xØ8.5	ØA = 54mm D = 42mm	B+ M8, D+ M5 E = 67mm	

DAN1002		14V	90A
Poly-VF 6 C = 55mm Mb = 3xØ8.5	ØA = 54mm D = 42mm	B+ M8, D+ M5 E = 67mm	

DAN1003		14V	70A
Poly-V 6 C = 55mm Mb = 3xØ8.5	ØA = 54mm D = 42mm	B+ M8, D+ M5 E = 67mm	

DAN1003		14V	70A
Poly-V 6 C = 55mm Mb = 3xØ8.5	ØA = 54mm D = 42mm	B+ M8, D+ M5 E = 67mm	

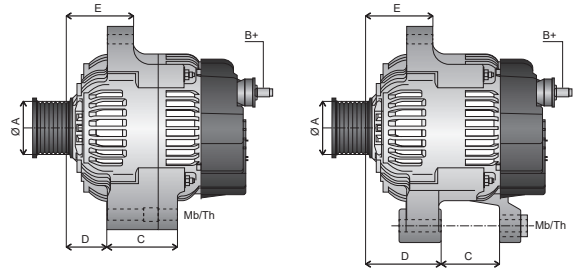

DAN1004		14V	90A
Poly-V 4	$\text{ØA} = 54\text{mm}$	B+ M8, D+ M5	
C = 32mm	D = 36mm	E = 171mm	
Mb = 2xØ10.2, 1x(11x44)			

DAN1004		14V	90A
Poly-V 4	$\text{ØA} = 54\text{mm}$	B+ M8, D+ M5	
C = 32mm	D = 36mm	E = 171mm	
Mb = 2xØ10.2, 1x(11x44)			

DAN1005		14V	105A
Poly-V 4	$\text{ØA} = 54\text{mm}$	B+ M8, D+ M5	
C = 32mm	D = 36mm	E = 171mm	
Mb = 2xØ10.2, 1x(11x44)			

DAN1005		14V	105A
Poly-V 4	$\text{ØA} = 54\text{mm}$	B+ M8, D+ M5	
C = 32mm	D = 36mm	E = 171mm	
Mb = 2xØ10.2, 1x(11x44)			

DAN1006		14V	85A
Poly-V 4	$\text{ØA} = 60\text{mm}$	B+ M6, PL07	
C = 58mm	D = 32mm	E = 48mm	
Mb = 1xØ10.2	Th = 1xM8		

DAN1006		14V	85A
Poly-V 4	$\text{ØA} = 60\text{mm}$	B+ M6, PL07	
C = 58mm	D = 32mm	E = 48mm	
Mb = 1xØ10.2	Th = 1xM8		

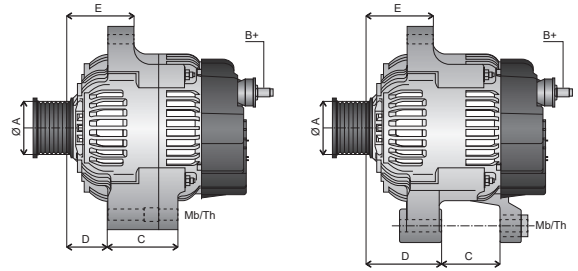

DAN1007		14V	75A
Poly-V 4 C = 58mm Mb = 1xØ10.2	ØA = 55mm D = 32mm Th = 1xM8	B+ M6, PL06 E = 48mm	

DAN1007		14V	75A
Poly-V 4 C = 58mm Mb = 1xØ10.2	ØA = 55mm D = 32mm Th = 1xM8	B+ M6, PL06 E = 48mm	



DAN1008		14V	60A
Poly-V 4 C = 58mm Mb = 1xØ10.2	ØA = 55mm D = 32mm Th = 1xM8	B+ M6, PL07 E = 48mm	



DAN1008		14V	60A
Poly-V 4 C = 58mm Mb = 1xØ10.2	ØA = 55mm D = 32mm Th = 1xM8	B+ M6, PL07 E = 48mm	

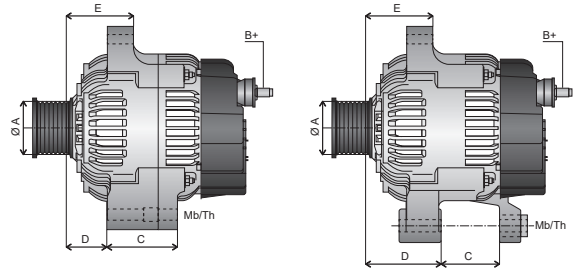

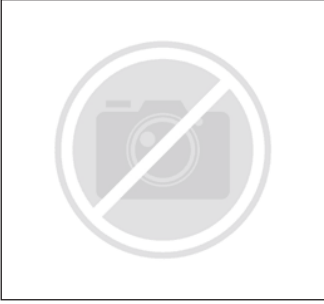
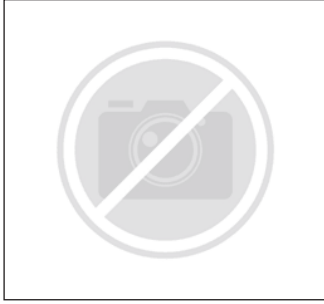

DAN1009		14V	130A
Poly-VF 6 C = 61mm Mb = 2xØ12.2	ØA = 54mm D = 52mm	B+ M8, D+ M5, DFM M6 E = 58mm	

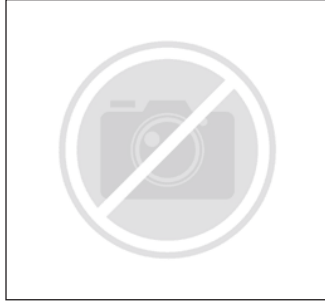
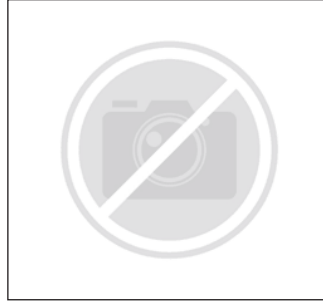



DAN1009		14V	130A
Poly-VF 6 C = 61mm Mb = 2xØ12.2	ØA = 54mm D = 52mm	B+ M8, D+ M5, DFM M6 E = 58mm	











DAN1011		14V	100A
 			
 Poly-VF 6 C = 51mm Mb = 1xØ11	ØA = 55mm D = 33mm Th = 1xM10, 1xM8	B+ M6, PL17 E = 56mm	

DAN1011		14V	100A
 			
 Poly-VF 6 C = 51mm Mb = 1xØ11	ØA = 55mm D = 33mm Th = 1xM10, 1xM8	B+ M6, PL17 E = 56mm	

DAN1012		14V	100A
 			
 Poly-VF 6 C = 37mm Mb = 1xØ11	ØA = 57.5mm D = 29mm Th = 1xM10, 1xM8	B+ M6, PL17 E = 65mm	

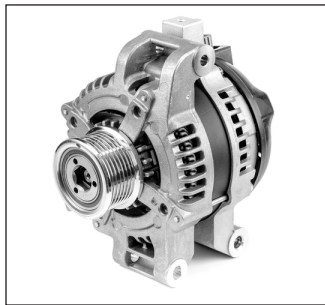
DAN1012		14V	100A
 			
 Poly-VF 6 C = 37mm Mb = 1xØ11	ØA = 57.5mm D = 29mm Th = 1xM10, 1xM8	B+ M6, PL17 E = 65mm	

DAN1013		14V	130A
 			
 Poly-VF 7 C = 71mm Mb = 1xØ10.4, 1xØ8.4, 1x(11.2x8.8)	ØA = 58mm D = 24mm	B+ M6, PL17 E = 55mm	

DAN1013		14V	130A
 			
 Poly-VF 7 C = 71mm Mb = 1xØ10.4, 1xØ8.4, 1x(11.2x8.8)	ØA = 58mm D = 24mm	B+ M6, PL17 E = 55mm	

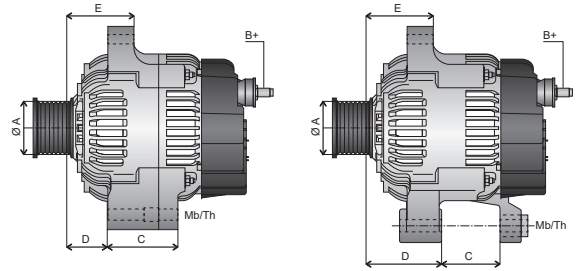

DAN1015		14V	100A
Poly-VF 6 C = 37mm Mb = 1xØ11	ØA = 57.5mm D = 29mm Th = 1xM10, 1xM8	B+ M6, PL16 E = 65mm	

DAN1015		14V	100A
Poly-VF 6 C = 37mm Mb = 1xØ11	ØA = 57.5mm D = 29mm Th = 1xM10, 1xM8	B+ M6, PL16 E = 65mm	

DAN1016		14V	120A
Poly-VF 6 C = 69mm Mb = 1xØ8.2, 1xØ9.2, 1x(8.2x9.2)	ØA = 49mm D = 75mm	B+ M8, PL10 E = 40mm	

DAN1016		14V	120A
Poly-VF 6 C = 69mm Mb = 1xØ8.2, 1xØ9.2, 1x(8.2x9.2)	ØA = 49mm D = 75mm	B+ M8, PL10 E = 40mm	

DAN1017		14V	100A
Poly-VF 6 C = 37mm Mb = 1xØ11	ØA = 67.5mm D = 29mm Th = 1xM10, 1xM8	B+ M6, PL17 E = 42mm	

DAN1017		14V	100A
Poly-VF 6 C = 37mm Mb = 1xØ11	ØA = 67.5mm D = 29mm Th = 1xM10, 1xM8	B+ M6, PL17 E = 42mm	

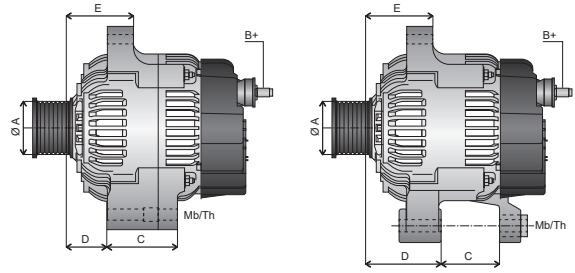

DAN1018		14V	100A
Poly-VF 6	$\text{ØA} = 58\text{mm}$	B+ M6, PL17	
C = 43mm	D = 48mm	E = 63mm	
Mb = 1xØ11	Th = 1xM10, 1xM8		

DAN1018		14V	100A
Poly-VF 6	$\text{ØA} = 58\text{mm}$	B+ M6, PL17	
C = 43mm	D = 48mm	E = 63mm	
Mb = 1xØ11	Th = 1xM10, 1xM8		



DAN1019		14V	100A
Poly-VF 6	$\text{ØA} = 55\text{mm}$	B+ M6, PL16	
C = 51mm	D = 33mm	E = 56mm	
Mb = 1xØ11	Th = 1xM10, 1xM8		



DAN1019		14V	100A
Poly-VF 6	$\text{ØA} = 55\text{mm}$	B+ M6, PL16	
C = 51mm	D = 33mm	E = 56mm	
Mb = 1xØ11	Th = 1xM10, 1xM8		

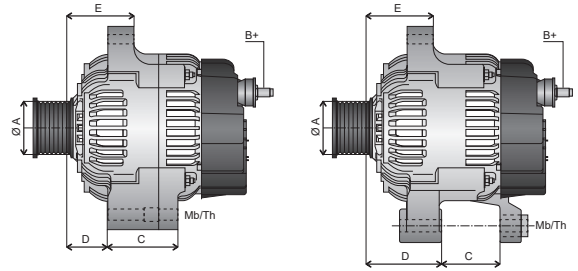

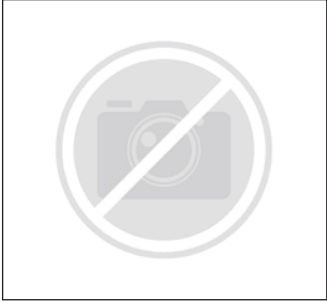
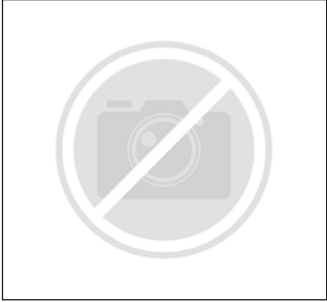
DAN1020		14V	80A
Poly-V 6	$\text{ØA} = 60\text{mm}$	B+ M6, PL17	
C = 37mm	D = 29mm	E = 42mm	
Mb = 1xØ11	Th = 1xM10, 1xM8		

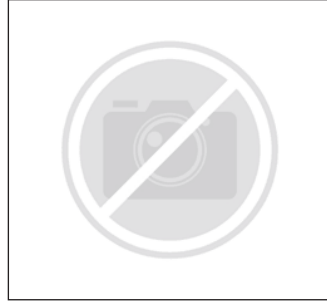
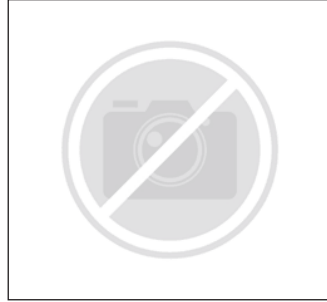

DAN1020		14V	80A
Poly-V 6	$\text{ØA} = 60\text{mm}$	B+ M6, PL17	
C = 37mm	D = 29mm	E = 42mm	
Mb = 1xØ11	Th = 1xM10, 1xM8		



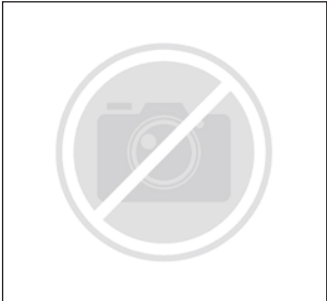
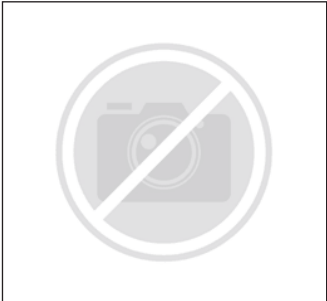

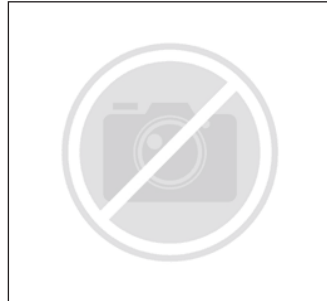
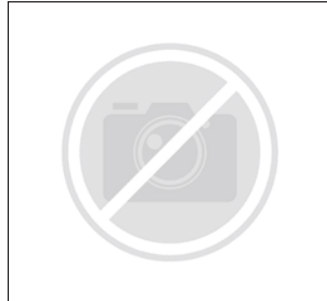

DAN1021		14V	90A
 			
 Poly-V 6 C = 40mm Mb = 1xØ11	ØA = 55mm D = 34mm Th = 1xM10, 1xM8	B+ M6, PL16 E = 56mm	

DAN1021		14V	90A
 			
 Poly-V 6 C = 40mm Mb = 1xØ11	ØA = 55mm D = 34mm Th = 1xM10, 1xM8	B+ M6, PL16 E = 56mm	

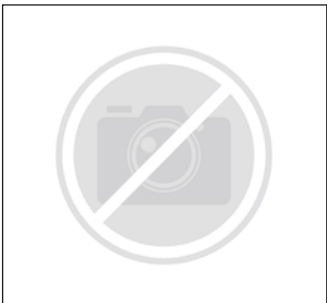
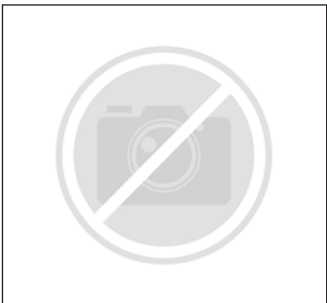

DAN1023		14V	120A
 			
 Poly-V 6 C = 69mm Mb = 1xØ8.2, 1xØ9.2, 1x(8.2x9.2)	ØA = 49mm D = 75mm	B+ M8, PL10 E = 40mm	

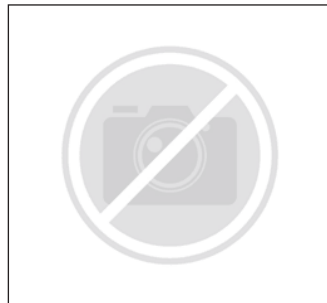
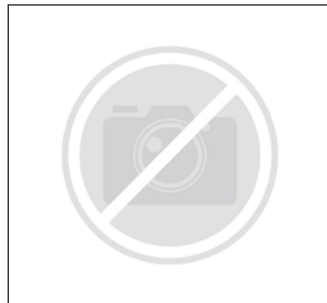

DAN1023		14V	120A
 			
 Poly-V 6 C = 69mm Mb = 1xØ8.2, 1xØ9.2, 1x(8.2x9.2)	ØA = 49mm D = 75mm	B+ M8, PL10 E = 40mm	

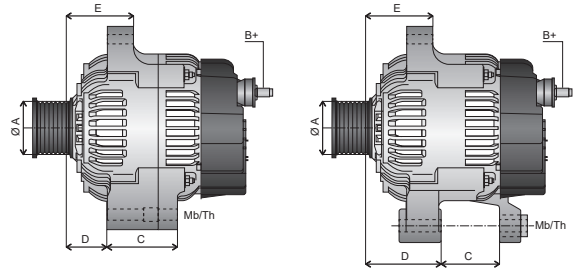

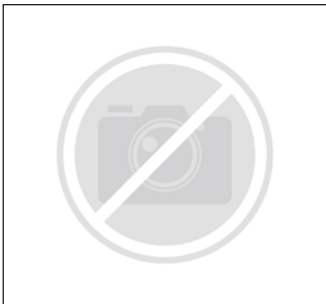
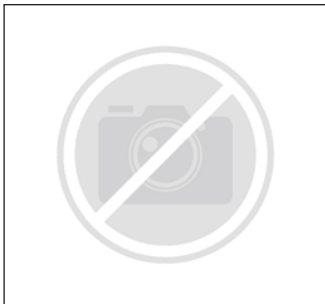
DAN1025		14V	80A
 			
 Poly-V 6 C = 37mm Mb = 1xØ11	ØA = 52.5mm D = 29mm Th = 1xM10, 1xM8	B+ M6, PL17 E = 67mm	

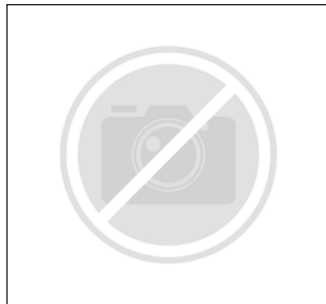
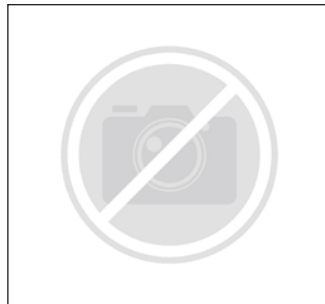

DAN1025		14V	80A
 			
 Poly-V 6 C = 37mm Mb = 1xØ11	ØA = 52.5mm D = 29mm Th = 1xM10, 1xM8	B+ M6, PL17 E = 67mm	



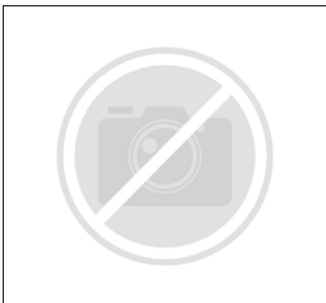
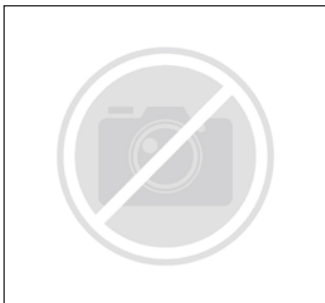



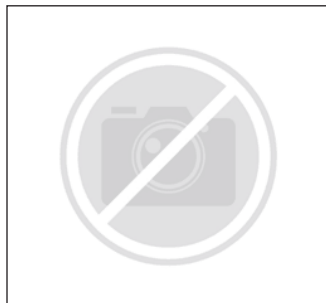
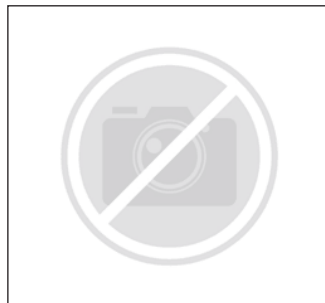

DAN1030		14V	100A
 			
 V 1 C = 80mm Mb = 1xØ9, 1xØ10.5	ØA = 84mm D = 42mm	B+ M8, PL03 	

DAN1030		14V	100A
 			
 V 1 C = 80mm Mb = 1xØ9, 1xØ10.5	ØA = 84mm D = 42mm	B+ M8, PL03 	

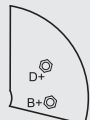
DAN1031		14V	80A
 			
 Poly-V 6 C = 80mm Mb = 1xØ10.5	ØA = 60mm D = 48mm Th = 1xM8	B+ M8, PL03 	

DAN1031		14V	80A
 			
 Poly-V 6 C = 80mm Mb = 1xØ10.5	ØA = 60mm D = 48mm Th = 1xM8	B+ M8, PL03 	

DAN1032		14V	70A
 			
 Poly-VF 6 C = 55mm Mb = 3xØ8.5	ØA = 54mm D = 42mm	B+ M8, D+ M5 E = 67mm 	

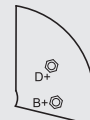
DAN1032		14V	70A
 			
 Poly-VF 6 C = 55mm Mb = 3xØ8.5	ØA = 54mm D = 42mm	B+ M8, D+ M5 E = 67mm 	

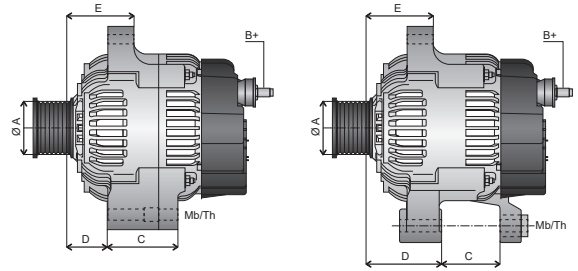

DAN1033		14V	105A
Poly-VF 6 C = 55mm Mb = 3xØ8.5	ØA = 54mm D = 42mm	B+ M8, D+ M5 E = 67mm	

DAN1033		14V	105A
Poly-VF 6 C = 55mm Mb = 3xØ8.5	ØA = 54mm D = 42mm	B+ M8, D+ M5 E = 67mm	

DAN1034		14V	120A
Poly-VF 6 C = 55mm Mb = 3xØ8.5	ØA = 54mm D = 42mm	B+ M8, D+ M5, DFM M6 E = 67mm	

DAN1034		14V	120A
Poly-VF 6 C = 55mm Mb = 3xØ8.5	ØA = 54mm D = 42mm	B+ M8, D+ M5, DFM M6 E = 67mm	

DAN1035		14V	70A
Poly-V 6 C = 37mm Mb = 1xØ11	ØA = 57.5mm D = 29mm Th = 1xM10, 1xM8	B+ M8, D+ M5 E = 42mm	

DAN1035		14V	70A
Poly-V 6 C = 37mm Mb = 1xØ11	ØA = 57.5mm D = 29mm Th = 1xM10, 1xM8	B+ M8, D+ M5 E = 42mm	

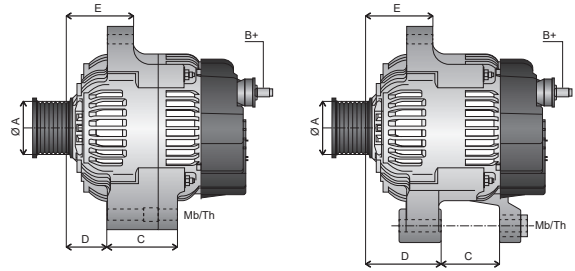

DAN1036		14V	80A
Poly-V 6	$\text{ØA} = 57.5\text{mm}$	B+ M8, D+ M5	
C = 37mm	D = 29mm	E = 42mm	
Mb = 1xØ11	Th = 1xM10, 1xM8		

DAN1036		14V	80A
Poly-V 6	$\text{ØA} = 57.5\text{mm}$	B+ M8, D+ M5	
C = 37mm	D = 29mm	E = 42mm	
Mb = 1xØ11	Th = 1xM10, 1xM8		

DAN1037		14V	90A
Poly-V 6	$\text{ØA} = 62\text{mm}$	B+ M8, D+ M5	
C = 55mm	D = 45mm	E = D	
Mb = 2xØ12.2, 1xØ10.2			

DAN1037		14V	90A
Poly-V 6	$\text{ØA} = 62\text{mm}$	B+ M8, D+ M5	
C = 55mm	D = 45mm	E = D	
Mb = 2xØ12.2, 1xØ10.2			

DAN1041		14V	120A
Poly-V 6	$\text{ØA} = 50\text{mm}$	B+ M8, PL10	
C = 50mm	D = 11mm	E = 69mm	
Mb = 2xØ12.5, 1xØ10.3			

DAN1041		14V	120A
Poly-V 6	$\text{ØA} = 50\text{mm}$	B+ M8, PL10	
C = 50mm	D = 11mm	E = 69mm	
Mb = 2xØ12.5, 1xØ10.3			

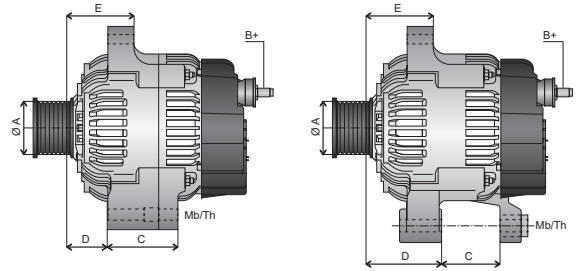

DAN1042		14V	80A
Poly-V 6 C = 37mm Mb = 1xØ11	ØA = 52.5mm D = 29mm Th = 1xM10, 1xM8	B+ M6, PL16 E = 67mm	

DAN1042		14V	80A
Poly-V 6 C = 37mm Mb = 1xØ11	ØA = 52.5mm D = 29mm Th = 1xM10, 1xM8	B+ M6, PL16 E = 67mm	

DAN1045		14V	100A
Poly-VF 7 C = 71mm Mb = 1xØ10.4, 1xØ8.4, 1x(11.2x8.8)	ØA = 58mm D = 24mm	B+ M6, PL16 E = 55mm	

DAN1045		14V	100A
Poly-VF 7 C = 71mm Mb = 1xØ10.4, 1xØ8.4, 1x(11.2x8.8)	ØA = 58mm D = 24mm	B+ M6, PL16 E = 55mm	

DAN1052		14V	100A
Poly-V 7 C = 45mm Mb = 1xØ11	ØA = 60mm D = 36mm Th = 1xM10, 1xM8	B+ M6, PL17 E = 74mm	

DAN1052		14V	100A
Poly-V 7 C = 45mm Mb = 1xØ11	ØA = 60mm D = 36mm Th = 1xM10, 1xM8	B+ M6, PL17 E = 74mm	

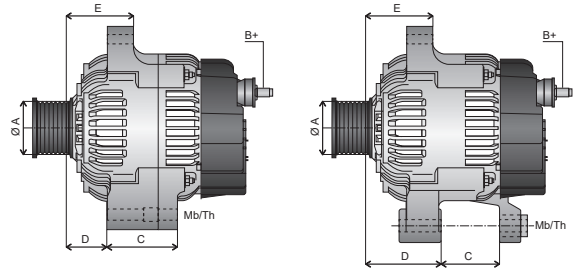

DAN1055		14V	70A
Poly-V 5 C = 57mm Mb = 2xØ11	ØA = 54mm D = 55mm Th = 2xM10	B+ M8, PL04 E = D	

DAN1055		14V	70A
Poly-V 5 C = 57mm Mb = 2xØ11	ØA = 54mm D = 55mm Th = 2xM10	B+ M8, PL04 E = D	

DAN1057		14V	90A
Poly-VF 6 C = 51mm Mb = 1xØ11	ØA = 55mm D = 33mm Th = 1xM10, 1xM8	B+ M6, PL17 E = 56mm	

DAN1057		14V	90A
Poly-VF 6 C = 51mm Mb = 1xØ11	ØA = 55mm D = 33mm Th = 1xM10, 1xM8	B+ M6, PL17 E = 56mm	

DAN1059		14V	150A
Poly-VF 5 C = 55mm Mb = 1xØ8.2, 1x(8.2x16.9), 1x(8.6x17.7)	ØA = 56mm D = 52mm	B+ M8, PL11 E = 74mm	

DAN1059		14V	150A
Poly-VF 5 C = 55mm Mb = 1xØ8.2, 1x(8.2x16.9), 1x(8.6x17.7)	ØA = 56mm D = 52mm	B+ M8, PL11 E = 74mm	

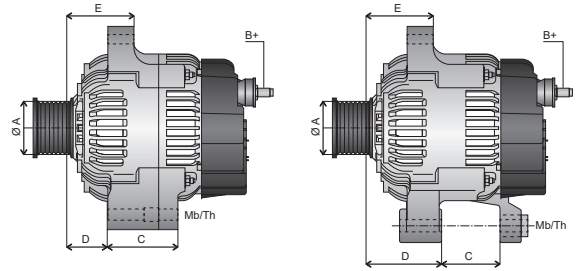

DAN1061		14V	90A
Poly-VF 6 C = 51mm Mb = 1xØ11	ØA = 55mm D = 33mm Th = 1xM10, 1xM8	B+ M6, PL16 E = 56mm	

DAN1061		14V	90A
Poly-VF 6 C = 51mm Mb = 1xØ11	ØA = 55mm D = 33mm Th = 1xM10, 1xM8	B+ M6, PL16 E = 56mm	

DAN1062		14V	140A
Poly-VF 6 C = 61mm Mb = 2xØ12.2	ØA = 62mm D = 52mm	B+ M8, D+ M5 E = 58mm	

DAN1062		14V	140A
Poly-VF 6 C = 61mm Mb = 2xØ12.2	ØA = 62mm D = 52mm	B+ M8, D+ M5 E = 58mm	

DAN1063		14V	80A
Poly-V 5 C = 56mm Mb = 1xØ10.2, 1xØ8.5	ØA = 56mm D = 19mm	B+ M8, PL01 E = 35mm	

DAN1063		14V	80A
Poly-V 5 C = 56mm Mb = 1xØ10.2, 1xØ8.5	ØA = 56mm D = 19mm	B+ M8, PL01 E = 35mm	

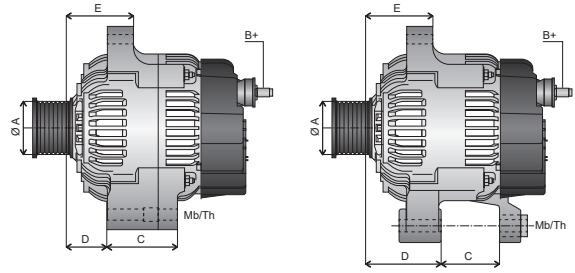

DAN1066		14V	120A
Poly-VF 6	ØA = 54mm	B+ M8, D+ M5	
C = 61mm	D = 52mm	E = 58mm	
Mb = 2xØ12.2			

DAN1066		14V	120A
Poly-VF 6	ØA = 54mm	B+ M8, D+ M5	
C = 61mm	D = 52mm	E = 58mm	
Mb = 2xØ12.2			

DAN1069		14V	130A
TOYOTA			
Poly-VF 7	ØA = 58mm	B+ M6, PL16	
C = 58mm	D = 38mm	E = 60mm	
Mb = 1xØ10	Th = 1xM8		

DAN1069		14V	130A
TOYOTA			
Poly-VF 7	ØA = 58mm	B+ M6, PL16	
C = 58mm	D = 38mm	E = 60mm	
Mb = 1xØ10	Th = 1xM8		

DAN1070		14V	100A
TOYOTA			
Poly-VF 7	ØA = 58mm	B+ M6, PL16	
C = 58mm	D = 38mm	E = 60mm	
Mb = 1xØ10	Th = 1xM8		

DAN1070		14V	100A
TOYOTA			
Poly-VF 7	ØA = 58mm	B+ M6, PL16	
C = 58mm	D = 38mm	E = 60mm	
Mb = 1xØ10	Th = 1xM8		

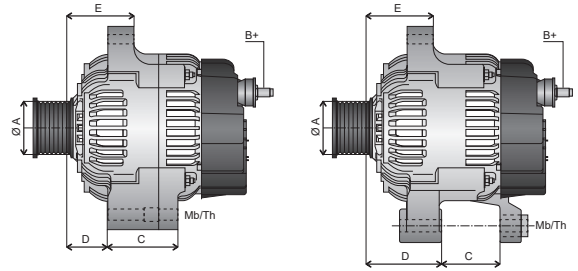

DAN1071		14V	90A
Poly-VF 6	ØA = 54.3mm	B+ M8, PL18	
C = 46mm	D = 43mm	E = D	
Mb = 2xØ10.6	Th = 2xM10		

DAN1071		14V	90A
Poly-VF 6	ØA = 54.3mm	B+ M8, PL18	
C = 46mm	D = 43mm	E = D	
Mb = 2xØ10.6	Th = 2xM10		

DAN1073		14V	150A
Poly-VF 6	ØA = 50mm	B+ M8, PL19	
C = 32mm	D = 43mm	E = D	
Mb = 1xØ8.6, 1xØ8.2	Th = 2xM8		

DAN1073		14V	150A
Poly-VF 6	ØA = 50mm	B+ M8, PL19	
C = 32mm	D = 43mm	E = D	
Mb = 1xØ8.6, 1xØ8.2	Th = 2xM8		

DAN1074		14V	150A
Poly-VF 6	ØA = 50mm	B+ M8, PL19	
C = 32mm	D = 43mm	E = D	
Mb = 1xØ8.6, 1xØ8.2	Th = 2xM8		

DAN1074		14V	150A
Poly-VF 6	ØA = 50mm	B+ M8, PL19	
C = 32mm	D = 43mm	E = D	
Mb = 1xØ8.6, 1xØ8.2	Th = 2xM8		

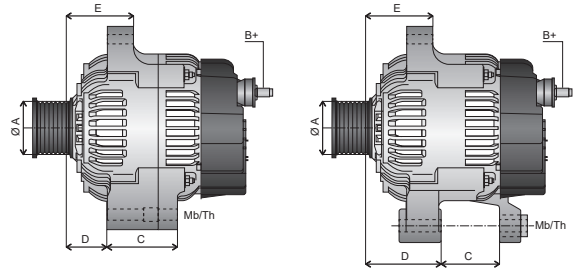

DAN1076		14V	100A
Poly-VF 6 C = 41mm Mb = 1xØ11	ØA = 62.5mm D = 32mm Th = 1xM10, 1xM8	B+ M6, PL16 E = 48mm	

DAN1076		14V	100A
Poly-VF 6 C = 41mm Mb = 1xØ11	ØA = 62.5mm D = 32mm Th = 1xM10, 1xM8	B+ M6, PL16 E = 48mm	

DAN1077		14V	80A
Poly-V 6 C = 37mm Mb = 1xØ11	ØA = 60mm D = 29mm Th = 1xM10, 1xM8	B+ M6, PL16 E = 42mm	

DAN1077		14V	80A
Poly-V 6 C = 37mm Mb = 1xØ11	ØA = 60mm D = 29mm Th = 1xM10, 1xM8	B+ M6, PL16 E = 42mm	

DAN1078		14V	120A
Poly-VF 5 C = 50mm Mb = 3xØ8.5	ØA = 54mm D = 17mm	B+ M8, PL19 E = 67mm	

DAN1078		14V	120A
Poly-VF 5 C = 50mm Mb = 3xØ8.5	ØA = 54mm D = 17mm	B+ M8, PL19 E = 67mm	

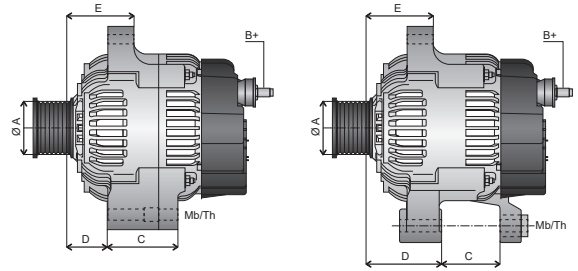

DAN1079		14V	80A
Poly-V 6 C = 40mm Mb = 1xØ11	ØA = 52.5mm D = 34mm Th = 1xM10, 1xM8	B+ M6, PL16 E = 56mm	

DAN1079		14V	80A
Poly-V 6 C = 40mm Mb = 1xØ11	ØA = 52.5mm D = 34mm Th = 1xM10, 1xM8	B+ M6, PL16 E = 56mm	

DAN1080		14V	80A
Poly-V 7 C = 31mm Mb = 2xØ11	ØA = 52.5mm D = 40mm Th = 1xM10	B+ M6, PL16 E = 43mm	

DAN1080		14V	80A
Poly-V 7 C = 31mm Mb = 2xØ11	ØA = 52.5mm D = 40mm Th = 1xM10	B+ M6, PL16 E = 43mm	

DAN1081		14V	80A
Poly-V 5 C = 37mm Mb = 1xØ11	ØA = 57.5mm D = 47mm Th = 1xM10, 1xM8	B+ M6, PL17 E = 53mm	

DAN1081		14V	80A
Poly-V 5 C = 37mm Mb = 1xØ11	ØA = 57.5mm D = 47mm Th = 1xM10, 1xM8	B+ M6, PL17 E = 53mm	

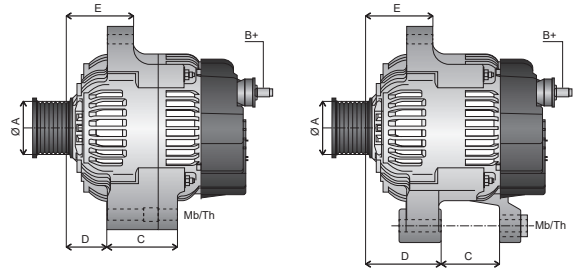

DAN1083		14V	120A
Poly-VF 5 C = 61mm Mb = 2xØ12.2	ØA = 54mm D = 55mm	B+ M8, D+ M5 E = 60mm	

DAN1083		14V	120A
Poly-VF 5 C = 61mm Mb = 2xØ12.2	ØA = 54mm D = 55mm	B+ M8, D+ M5 E = 60mm	



DAN1084		14V	120A
Poly-VF 6 C = 61mm Mb = 2xØ12.2	ØA = 54mm D = 52mm	B+ M8, D+ M5 E = 58mm	



DAN1084		14V	120A
Poly-VF 6 C = 61mm Mb = 2xØ12.2	ØA = 54mm D = 52mm	B+ M8, D+ M5 E = 58mm	

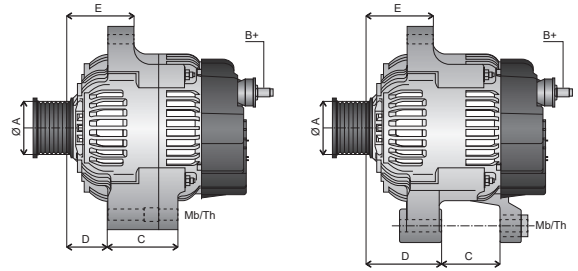

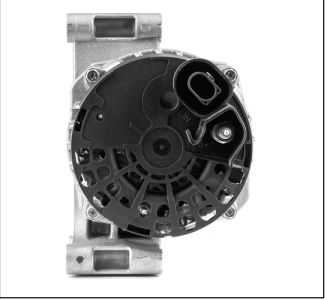

DAN1085		14V	120A
Poly-V 5 C = 50mm Mb = 3xØ8.5	ØA = 54mm D = 17mm	B+ M8, D+ M5 E = 67mm	

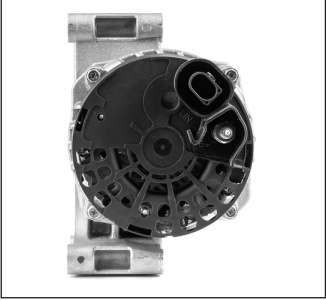



DAN1085		14V	120A
Poly-V 5 C = 50mm Mb = 3xØ8.5	ØA = 54mm D = 17mm	B+ M8, D+ M5 E = 67mm	











DAN1086		14V	120A
 			
 Poly-VF 6 C = 55mm Mb = 3xØ8.5	ØA = 54mm D = 42mm	B+ M8, PL19 E = 67mm	

DAN1086		14V	120A
 			
 Poly-VF 6 C = 55mm Mb = 3xØ8.5	ØA = 54mm D = 42mm	B+ M8, PL19 E = 67mm	

DAN1089		14V	120A
 			
 Poly-VF 5 C = 50mm Mb = 3xØ8.5	ØA = 54mm D = 17mm	B+ M8, PL19 E = 67mm	

DAN1089		14V	120A
 			
 Poly-VF 5 C = 50mm Mb = 3xØ8.5	ØA = 54mm D = 17mm	B+ M8, PL19 E = 67mm	

DAN1093		14V	100A
 			
 Poly-VF 4 C = 37mm Mb = 1xØ11	ØA = 62.5mm D = 30mm Th = 1xM10, 1xM8	B+ M6, PL21 E = 67mm	

DAN1093		14V	100A
 			
 Poly-VF 4 C = 37mm Mb = 1xØ11	ØA = 62.5mm D = 30mm Th = 1xM10, 1xM8	B+ M6, PL21 E = 67mm	

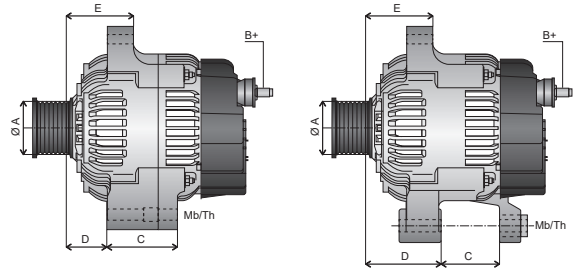

DAN1094		14V	100A
Poly-VF 6 C = 43mm Mb = 1xØ11	ØA = 58mm D = 48mm Th = 1xM10, 1xM8	B+ M6, PL21 E = 63mm	LIN

DAN1094		14V	100A
Poly-VF 6 C = 43mm Mb = 1xØ11	ØA = 58mm D = 48mm Th = 1xM10, 1xM8	B+ M6, PL21 E = 63mm	LIN

DAN1095		14V	100A
Poly-VF 7 C = 71mm Mb = 1xØ10.4, 1xØ8.4, 1x(11.2x8.8)	ØA = 58mm D = 24mm	B+ M6, PL21 E = 55mm	LIN

DAN1095		14V	100A
Poly-VF 7 C = 71mm Mb = 1xØ10.4, 1xØ8.4, 1x(11.2x8.8)	ØA = 58mm D = 24mm	B+ M6, PL21 E = 55mm	LIN

DAN1096		14V	90A
Poly-VF 6 C = 51mm Mb = 1xØ11	ØA = 55mm D = 33mm Th = 1xM10, 1xM8	B+ M6, PL21 E = 56mm	LIN

DAN1096		14V	90A
Poly-VF 6 C = 51mm Mb = 1xØ11	ØA = 55mm D = 33mm Th = 1xM10, 1xM8	B+ M6, PL21 E = 56mm	LIN

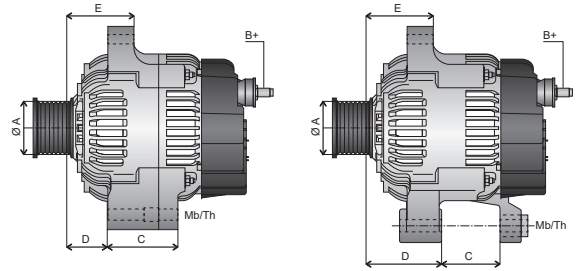

DAN1098		14V	100A
Poly-VF 6 C = 51mm Mb = 1xØ11	ØA = 55mm D = 33mm Th = 1xM10, 1xM8	B+ M6, PL21 E = 56mm	 LIN

DAN1098		14V	100A
Poly-VF 6 C = 51mm Mb = 1xØ11	ØA = 55mm D = 33mm Th = 1xM10, 1xM8	B+ M6, PL21 E = 56mm	 LIN

DAN1100		14V	80A
Poly-VF 4 C = 37mm Mb = 1xØ11	ØA = 52.5mm D = 30mm Th = 1xM10, 1xM8	B+ M6, PL21 E = 67mm	 LIN

DAN1100		14V	80A
Poly-VF 4 C = 37mm Mb = 1xØ11	ØA = 52.5mm D = 30mm Th = 1xM10, 1xM8	B+ M6, PL21 E = 67mm	 LIN

DAN1102		14V	150A
Poly-VF 6 C = 37mm Mb = 1xØ11	ØA = 55mm D = 52mm Th = 2xM10	B+ M8, PL22 E = 39mm	 L C FR

DAN1102		14V	150A
Poly-VF 6 C = 37mm Mb = 1xØ11	ØA = 55mm D = 52mm Th = 2xM10	B+ M8, PL22 E = 39mm	 L C FR

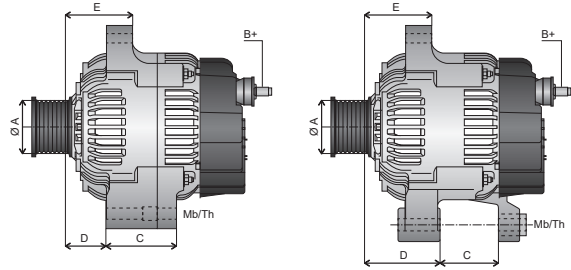

DAN1103		14V	150A
Poly-V 6 C = 47mm Mb = 1xØ12.8, 1xØ10.2, 1x(14.2x11.5)	ØA = 53.8mm D = 22mm	B+ M8, PL19 E = 66mm	

DAN1103		14V	150A
Poly-V 6 C = 47mm Mb = 1xØ12.8, 1xØ10.2, 1x(14.2x11.5)	ØA = 53.8mm D = 22mm	B+ M8, PL19 E = 66mm	

DAN1104		14V	150A
Poly-VF 7 C = 74mm Mb = 1xØ12.8, 1xØ10.8, 1xØ10.2	ØA = 58.8mm D = 43mm	B+ M8, PL19 E = 49mm	

DAN1104		14V	150A
Poly-VF 7 C = 74mm Mb = 1xØ12.8, 1xØ10.8, 1xØ10.2	ØA = 58.8mm D = 43mm	B+ M8, PL19 E = 49mm	

DAN1105		14V	150A
Poly-VF 6 C = 47mm Mb = 1xØ12.8, 1xØ10.2, 1x(14.2x11.5)	ØA = 53.8mm D = 22mm	B+ M8, PL19 E = 66mm	

DAN1105		14V	150A
Poly-VF 6 C = 47mm Mb = 1xØ12.8, 1xØ10.2, 1x(14.2x11.5)	ØA = 53.8mm D = 22mm	B+ M8, PL19 E = 66mm	

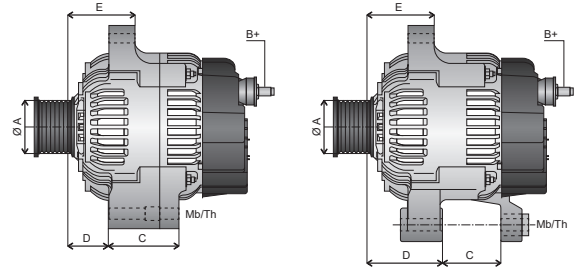

DAN1106		14V	150A
Poly-VF 6 C = 47mm Mb = 1xØ12.8, 1xØ10.2, 1x(14.2x11.5)	ØA = 53.8mm D = 22mm	B+ M8, PL09 E = 66mm	

DAN1106		14V	150A
Poly-VF 6 C = 47mm Mb = 1xØ12.8, 1xØ10.2, 1x(14.2x11.5)	ØA = 53.8mm D = 22mm	B+ M8, PL09 E = 66mm	



DAN1110		14V	220A
Poly-V 6 C = 47mm Mb = 1xØ12.8, 1xØ10.2, 1x(14.2x11.5)	ØA = 53.8mm D = 22mm	B+ M8, PL19 E = 66mm	



DAN1110		14V	220A
Poly-V 6 C = 47mm Mb = 1xØ12.8, 1xØ10.2, 1x(14.2x11.5)	ØA = 53.8mm D = 22mm	B+ M8, PL19 E = 66mm	

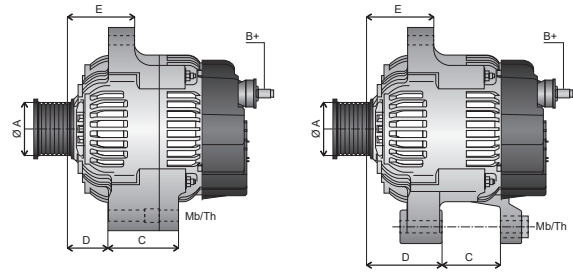

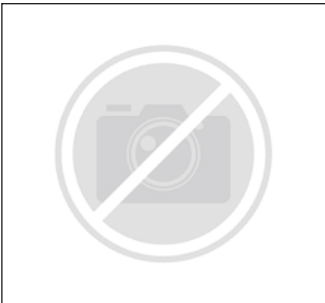
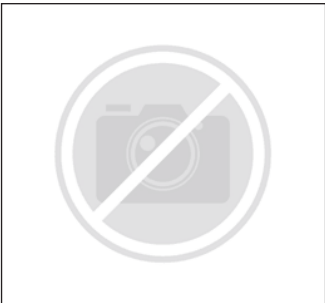

DAN1111		14V	180A
Poly-VF 6 C = 45mm Mb = 1xØ10.6, 1xØ10.2	ØA = 53.8mm D = 43mm Th = 2xM10	B+ M8, PL19 E = D	

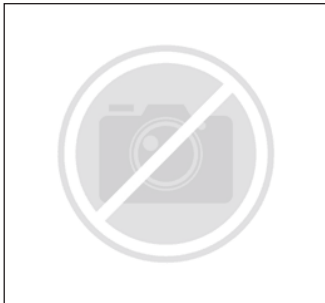
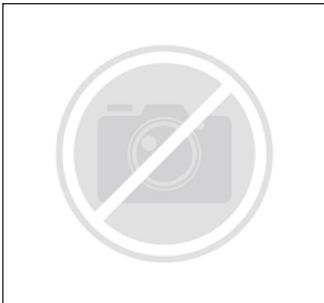



DAN1111		14V	180A
Poly-VF 6 C = 45mm Mb = 1xØ10.6, 1xØ10.2	ØA = 53.8mm D = 43mm Th = 2xM10	B+ M8, PL19 E = D	











DAN1112		14V	180A
 			
 Poly-VF 6 C = 47mm Mb = 1xØ12.8, 1xØ10.2, 1x(14.2x11.5)	ØA = 53.8mm D = 22mm	B+ M8, PL19 E = 66mm	

DAN1112		14V	180A
 			
 Poly-VF 6 C = 47mm Mb = 1xØ12.8, 1xØ10.2, 1x(14.2x11.5)	ØA = 53.8mm D = 22mm	B+ M8, PL19 E = 66mm	

DAN1114		14V	80A
 			
 V 2 C = 58mm Mb = 1xØ10.2	ØA = 76.5mm D = 34mm Th = 1xM8	B+ M6, PL05 E = 56mm	

DAN1114		14V	80A
 			
 V 2 C = 58mm Mb = 1xØ10.2	ØA = 76.5mm D = 34mm Th = 1xM8	B+ M6, PL05 E = 56mm	

DAN1118		14V	150A
 			
 Poly-VF 6 C = 46mm Mb = 1xØ10.1, 1xØ10.6	ØA = 54.3mm D = 43mm Th = 2xM10	B+ M8, PL10 E = D	

DAN1118		14V	150A
 			
 Poly-VF 6 C = 46mm Mb = 1xØ10.1, 1xØ10.6	ØA = 54.3mm D = 43mm Th = 2xM10	B+ M8, PL10 E = D	

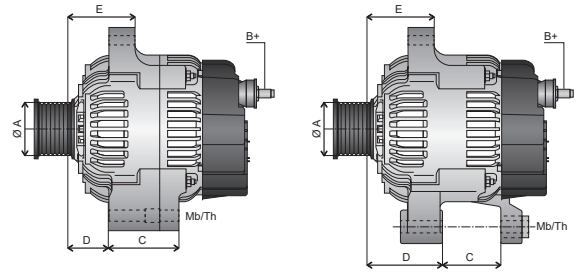

DAN1119		14V	120A
Poly-VF 6 C = 46mm Mb = 1xØ10.1, 1xØ10.6	ØA = 54.3mm D = 43mm Th = 2xM10	B+ M8, PL10 E = D	

DAN1119		14V	120A
Poly-VF 6 C = 46mm Mb = 1xØ10.1, 1xØ10.6	ØA = 54.3mm D = 43mm Th = 2xM10	B+ M8, PL10 E = D	

DAN1121		14V	120A
Poly-VF 6 C = 61mm Mb = 2xØ12.2	ØA = 54mm D = 52mm	B+ M8, PL19 E = 58mm	

DAN1121		14V	120A
Poly-VF 6 C = 61mm Mb = 2xØ12.2	ØA = 54mm D = 52mm	B+ M8, PL19 E = 58mm	

DAN1123		14V	150A
Poly-VF 6 C = 61mm Mb = 2xØ12.2	ØA = 54mm D = 52mm	B+ M8, D+ M5 E = 58mm	

DAN1123		14V	150A
Poly-VF 6 C = 61mm Mb = 2xØ12.2	ØA = 54mm D = 52mm	B+ M8, D+ M5 E = 58mm	

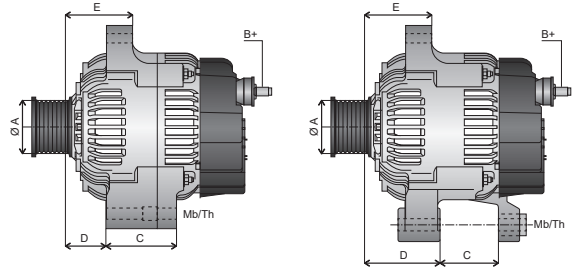

DAN1124		14V	90A
C = 62mm	D = 86mm	B+ M6, PL10	
Mb = 2xØ8.2	Th = 2XM8	E = D	

DAN1124		14V	90A
C = 62mm	D = 86mm	B+ M6, PL10	
Mb = 2xØ8.2	Th = 2XM8	E = D	

DAN1125		14V	170A
Poly-VF 6	ØA = 49mm	B+ M8, PL25	
C = 75mm	D = 50mm	E = D	
Mb = 1xØ10.5, 1xØ10.2	Th = 1xM10		

DAN1125		14V	170A
Poly-VF 6	ØA = 49mm	B+ M8, PL25	
C = 75mm	D = 50mm	E = D	
Mb = 1xØ10.5, 1xØ10.2	Th = 1xM10		

DAN1126		14V	170A
Poly-VF 6	ØA = 49mm	B+ M8, PL25	
C = 75mm	D = 50mm	E = D	
Mb = 1xØ10.5, 1xØ10.2	Th = 1xM10		

DAN1126		14V	170A
Poly-VF 6	ØA = 49mm	B+ M8, PL25	
C = 75mm	D = 50mm	E = D	
Mb = 1xØ10.5, 1xØ10.2	Th = 1xM10		

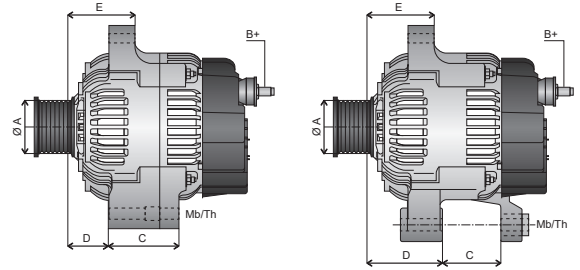

DAN1127		14V	210A
Poly-VF 6	$\text{ØA} = 49\text{mm}$	B+ M8, PL25	LIN
C = 75mm	D = 50mm	E = D	
Mb = 1xØ10.5, 1xØ10.2	Th = 1xM10		

DAN1127		14V	210A
Poly-VF 6	$\text{ØA} = 49\text{mm}$	B+ M8, PL25	LIN
C = 75mm	D = 50mm	E = D	
Mb = 1xØ10.5, 1xØ10.2	Th = 1xM10		

DAN1133		14V	170A
Poly-VF 7	$\text{ØA} = 49\text{mm}$	B+ M8, PL25	LIN
C = 41mm	D = 30mm	E = D	
Mb = 2xØ10.6, 1xØ8, 1x(9.5x8)			

DAN1133		14V	170A
Poly-VF 7	$\text{ØA} = 49\text{mm}$	B+ M8, PL25	LIN
C = 41mm	D = 30mm	E = D	
Mb = 2xØ10.6, 1xØ8, 1x(9.5x8)			

DAN1135		14V	210A
Poly-V 8	$\text{ØA} = 49\text{mm}$	B+ M8, PL25	LIN
C = 41mm	D = 30mm	E = D	
Mb = 2xØ10.6, 1xØ8, 1x(9.5x8)			

DAN1135		14V	210A
Poly-V 8	$\text{ØA} = 49\text{mm}$	B+ M8, PL25	LIN
C = 41mm	D = 30mm	E = D	
Mb = 2xØ10.6, 1xØ8, 1x(9.5x8)			

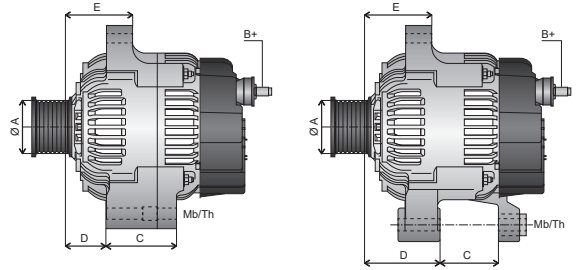

DAN1137		14V	210A
Poly-VF 8 C = 41mm Mb = 2xØ10.6, 1xØ8, 1x(9.5x8)	ØA = 49mm D = 30mm	B+ M8, PL25 E = D	

DAN1137		14V	210A
Poly-VF 8 C = 41mm Mb = 2xØ10.6, 1xØ8, 1x(9.5x8)	ØA = 49mm D = 30mm	B+ M8, PL25 E = D	

DAN1138		14V	210A
Poly-V 7 C = 41mm Mb = 2xØ10.6, 1xØ8, 1x(9.5x8)	ØA = 49mm D = 30mm Th = 1xM10	B+ M8, PL25 E = D	

DAN1138		14V	210A
Poly-V 7 C = 41mm Mb = 2xØ10.6, 1xØ8, 1x(9.5x8)	ØA = 49mm D = 30mm Th = 1xM10	B+ M8, PL25 E = D	

DAN1139		14V	120A
Poly-VF 6 C = 46mm Mb = 1xØ10.1, 1xØ10.6	ØA = 54.3mm D = 43mm Th = 2xM10	B+ M8, PL10 E = D	

DAN1139		14V	120A
Poly-VF 6 C = 46mm Mb = 1xØ10.1, 1xØ10.6	ØA = 54.3mm D = 43mm Th = 2xM10	B+ M8, PL10 E = D	

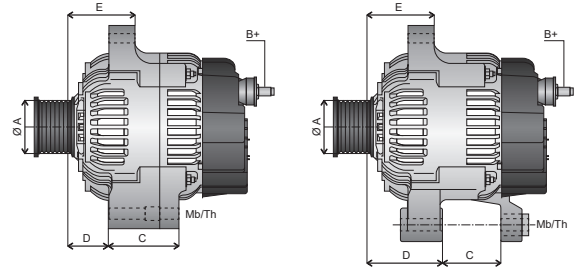

DAN1140		14V	105A
Poly-V 6 C = 55mm Mb = 2xØ12.2, 1xØ10.8	ØA = 62mm D = 45mm	B+ M8, D+ M5 E = D	

DAN1140		14V	105A
Poly-V 6 C = 55mm Mb = 2xØ12.2, 1xØ10.8	ØA = 62mm D = 45mm	B+ M8, D+ M5 E = D	

DAN1141		14V	120A
Poly-VF 6 C = 55mm Mb = 3xØ8.5	ØA = 54mm D = 42mm	B+ M8, D+ M5 E = 67mm	

DAN1141		14V	120A
Poly-VF 6 C = 55mm Mb = 3xØ8.5	ØA = 54mm D = 42mm	B+ M8, D+ M5 E = 67mm	

DAN1143		14V	130A
Poly-V 6 C = 48mm Mb = 2xØ12.2, 1xØ10.5	ØA = 60mm D = 30mm Th = 1xM10	B+ M8, PL14 E = 41mm	

DAN1143		14V	130A
Poly-V 6 C = 48mm Mb = 2xØ12.2, 1xØ10.5	ØA = 60mm D = 30mm Th = 1xM10	B+ M8, PL14 E = 41mm	

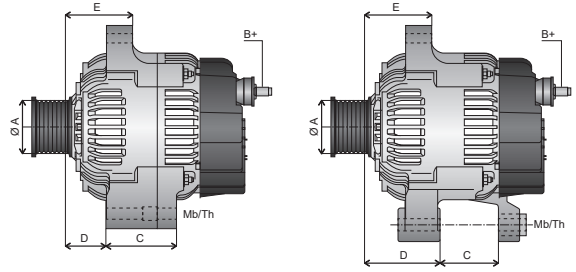

DAN1145		14V	150A
Poly-VF 6 C = 61mm Mb = 2xØ12.2	ØA = 54mm D = 52mm	B+ M8, PL19 E = 58mm	

DAN1145		14V	150A
Poly-VF 6 C = 61mm Mb = 2xØ12.2	ØA = 54mm D = 52mm	B+ M8, PL19 E = 58mm	

DAN1146		14V	150A
Poly-VF 6 C = 61mm Mb = 2xØ12.2	ØA = 54mm D = 52mm	B+ M8, PL19 E = 58mm	

DAN1146		14V	150A
Poly-VF 6 C = 61mm Mb = 2xØ12.2	ØA = 54mm D = 52mm	B+ M8, PL19 E = 58mm	

DAN1147		14V	100A
Poly-VF 6 C = 61mm Mb = 2xØ12.2	ØA = 54mm D = 52mm	B+ M8, D+ M5 E = 58mm	

DAN1147		14V	100A
Poly-VF 6 C = 61mm Mb = 2xØ12.2	ØA = 54mm D = 52mm	B+ M8, D+ M5 E = 58mm	

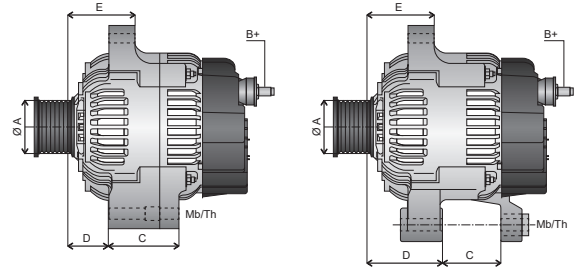

DAN1148		14V	105A
Poly-V 7 C = 38mm Mb = 1xØ9, 1xØ8.5	ØA = 60mm D = 45mm Th = 1xM8	B+ M6, PL14 E = 37mm	

DAN1148		14V	105A
Poly-V 7 C = 38mm Mb = 1xØ9, 1xØ8.5	ØA = 60mm D = 45mm Th = 1xM8	B+ M6, PL14 E = 37mm	

DAN1201		14V	130A
Poly-V 6 C = 58mm Mb = 1xØ10.2, 1xØ8.5	ØA = 49.5mm D = 32mm	B+ M8, PL19 E = 54mm	

DAN1201		14V	130A
Poly-V 6 C = 58mm Mb = 1xØ10.2, 1xØ8.5	ØA = 49.5mm D = 32mm	B+ M8, PL19 E = 54mm	

DAN1202		14V	220A
Poly-VF 6 C = 45mm Mb = 1xØ10.6, 1xØ10.2	ØA = 53.8mm D = 43mm Th = 2xM10	B+ M8, PL19 E = D	

DAN1202		14V	220A
Poly-VF 6 C = 45mm Mb = 1xØ10.6, 1xØ10.2	ØA = 53.8mm D = 43mm Th = 2xM10	B+ M8, PL19 E = D	

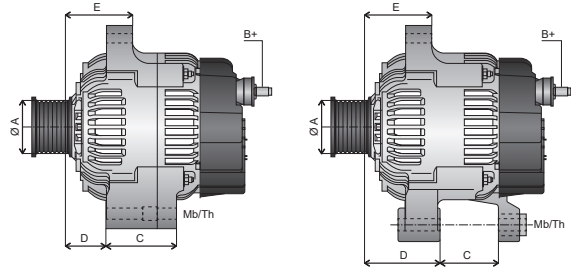

DAN1203		14V	180A
Poly-VF 6	$\text{ØA} = 53.8\text{mm}$	B+ M8, PL19	
C = 45mm	D = 43mm	E = D	
Mb = 1xØ10.6, 1xØ10.2	Th = 2xM10		

DAN1203		14V	180A
Poly-VF 6	$\text{ØA} = 53.8\text{mm}$	B+ M8, PL19	
C = 45mm	D = 43mm	E = D	
Mb = 1xØ10.6, 1xØ10.2	Th = 2xM10		

DAN1205		14V	150A
Poly-V 8	$\text{ØA} = 55\text{mm}$	B+ M6, PL16	
C = 67/35mm	D = 26mm	E = 54mm	
Mb = 2xØ12.4, 2xØ10.6	Th = 1xM8		

DAN1205		14V	150A
Poly-V 8	$\text{ØA} = 55\text{mm}$	B+ M6, PL16	
C = 67/35mm	D = 26mm	E = 54mm	
Mb = 2xØ12.4, 2xØ10.6	Th = 1xM8		

DAN1208		14V	180A
Poly-V 8	$\text{ØA} = 57.5\text{mm}$	B+ M8, PL16	
C = 67/35mm	D = 26mm	E = 54mm	
Mb = 2xØ12.4, 2xØ10.6	Th = 1xM8		

DAN1208		14V	180A
Poly-V 8	$\text{ØA} = 57.5\text{mm}$	B+ M8, PL16	
C = 67/35mm	D = 26mm	E = 54mm	
Mb = 2xØ12.4, 2xØ10.6	Th = 1xM8		

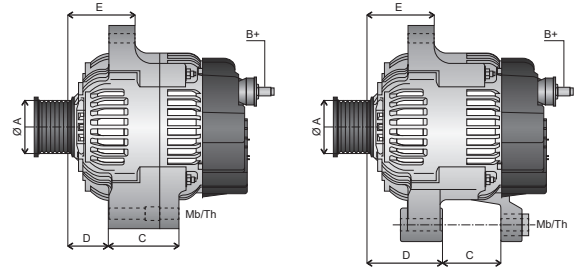

DAN1209		14V	180A
Poly-V 9 C = 64mm Mb = 3xØ10, 2xØ8.7	ØA = 57.5mm D = 22mm	B+ M8, PL16 E = D	

DAN1209		14V	180A
Poly-V 9 C = 64mm Mb = 3xØ10, 2xØ8.7	ØA = 57.5mm D = 22mm	B+ M8, PL16 E = D	

DAN1212		14V	80A
Poly-V 5 C = 37mm Mb = 1xØ11	ØA = 52.5mm D = 31mm Th = 1xM10, 1xM8	B+ M6, PL17 E = 57mm	

DAN1212		14V	80A
Poly-V 5 C = 37mm Mb = 1xØ11	ØA = 52.5mm D = 31mm Th = 1xM10, 1xM8	B+ M6, PL17 E = 57mm	

DAN1279		14V	130A
Poly-V 6 C = 58mm Mb = 2xØ11.3, 1xØ8.5	ØA = 55mm D = 32mm	B+ M8, PL16 E = 70mm	

DAN1279		14V	130A
Poly-V 6 C = 58mm Mb = 2xØ11.3, 1xØ8.5	ØA = 55mm D = 32mm	B+ M8, PL16 E = 70mm	

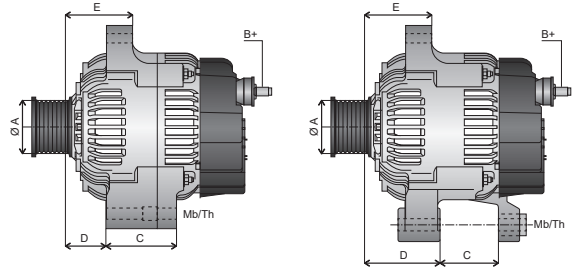

DAN1281		14V	180A
Poly-V 6 C = 80/58mm Mb = 1xØ12, 1xØ11.3, 2xØ10.4	ØA = 60mm D = 22mm	B+ M8, PL17 E = 32mm	

DAN1281		14V	180A
Poly-V 6 C = 80/58mm Mb = 1xØ12, 1xØ11.3, 2xØ10.4	ØA = 60mm D = 22mm	B+ M8, PL17 E = 32mm	

DAN1282		14V	80A
Poly-V 7 C = 46mm Mb = 1xØ11.3	ØA = 55mm D = 36mm Th = 1xM10, 1xM8	B+ M6, PL16 E = 68mm	

DAN1282		14V	80A
Poly-V 7 C = 46mm Mb = 1xØ11.3	ØA = 55mm D = 36mm Th = 1xM10, 1xM8	B+ M6, PL16 E = 68mm	

DAN1305		14V	120A
Poly-VF 6 C = 61mm Mb = 2xØ12.2	ØA = 54mm D = 52mm	B+ M8, PL19 E = 58mm	

DAN1305		14V	120A
Poly-VF 6 C = 61mm Mb = 2xØ12.2	ØA = 54mm D = 52mm	B+ M8, PL19 E = 58mm	

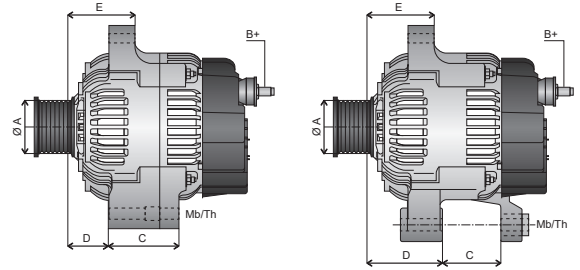

DAN1309		14V	100A
Poly-VF 4 C = 37mm Mb = 1xØ11	ØA = 62.5mm D = 30mm Th = 1xM10, 1xM8	B+ M6, PL16 E = 67mm	

DAN1309		14V	100A
Poly-VF 4 C = 37mm Mb = 1xØ11	ØA = 62.5mm D = 30mm Th = 1xM10, 1xM8	B+ M6, PL16 E = 67mm	

DAN1310		14V	120A
Poly-VF 6 C = 55mm Mb = 3xØ8.5	ØA = 54mm D = 42mm	B+ M8, PL19 E = 67mm	

DAN1310		14V	120A
Poly-VF 6 C = 55mm Mb = 3xØ8.5	ØA = 54mm D = 42mm	B+ M8, PL19 E = 67mm	

DAN1311		14V	120A
Poly-VF 6 C = 55mm Mb = 3xØ8.5	ØA = 54mm D = 42mm	B+ M8, D+ M5 E = 67mm	

DAN1311		14V	120A
Poly-VF 6 C = 55mm Mb = 3xØ8.5	ØA = 54mm D = 42mm	B+ M8, D+ M5 E = 67mm	

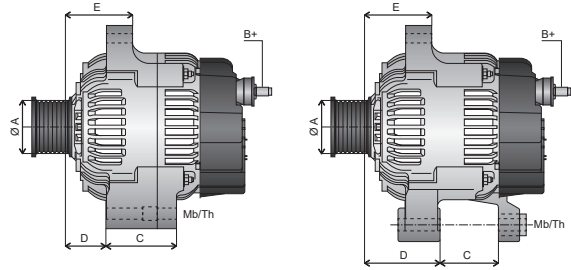

DAN1312		14V	120A
Poly-VF 6	ØA = 50mm	B+ M8, PL19	
C = 32mm	D = 43mm	E = D	
Mb = 1xØ8.6, 1xØ8.2	Th = 2xM8		

DAN1312		14V	120A
Poly-VF 6	ØA = 50mm	B+ M8, PL19	
C = 32mm	D = 43mm	E = D	
Mb = 1xØ8.6, 1xØ8.2	Th = 2xM8		

DAN1313		14V	120A
Poly-VF 6	ØA = 50mm	B+ M8, PL19	
C = 32mm	D = 43mm	E = D	
Mb = 1xØ8.6, 1xØ8.2	Th = 2xM8		

DAN1313		14V	120A
Poly-VF 6	ØA = 50mm	B+ M8, PL19	
C = 32mm	D = 43mm	E = D	
Mb = 1xØ8.6, 1xØ8.2	Th = 2xM8		

DAN1315		14V	100A
Poly-VF 6	ØA = 67.5mm	B+ M6, PL21	
C = 37mm	D = 29mm	E = 42mm	
Mb = 1xØ11	Th = 1xM10, 1xM8		

DAN1315		14V	100A
Poly-VF 6	ØA = 67.5mm	B+ M6, PL21	
C = 37mm	D = 29mm	E = 42mm	
Mb = 1xØ11	Th = 1xM10, 1xM8		

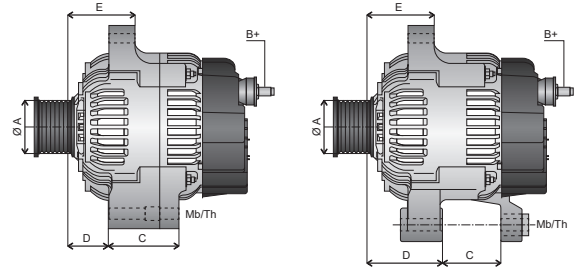

DAN1316		14V	100A
Poly-V 5 C = 58mm Mb = 1xØ10.2	ØA = 55mm D = 32mm Th = 1xM8	B+ M8, PL19 E = 48mm	LIN

DAN1316		14V	100A
Poly-V 5 C = 58mm Mb = 1xØ10.2	ØA = 55mm D = 32mm Th = 1xM8	B+ M8, PL19 E = 48mm	LIN

DAN1317		14V	100A
Poly-VF 7 C = 71mm Mb = 1xØ10.4, 1xØ8.4, 1x(11.2x8.8)	ØA = 58mm D = 24mm	B+ M6, PL17 E = 55mm	

DAN1317		14V	100A
Poly-VF 7 C = 71mm Mb = 1xØ10.4, 1xØ8.4, 1x(11.2x8.8)	ØA = 58mm D = 24mm	B+ M6, PL17 E = 55mm	

DAN1318		14V	100A
Poly-VF 6 C = 51mm Mb = 1xØ11	ØA = 55mm D = 33mm Th = 1xM10, 1xM8	B+ M6, PL17 E = 56mm	

DAN1318		14V	100A
Poly-VF 6 C = 51mm Mb = 1xØ11	ØA = 55mm D = 33mm Th = 1xM10, 1xM8	B+ M6, PL17 E = 56mm	

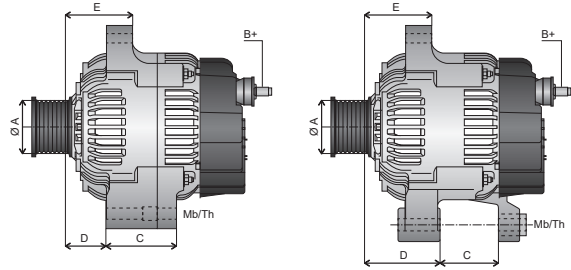

DAN1322		14V	100A
OPEL			
Poly-VF 5 C = 58mm Mb = 1xØ12, 1xØ11	ØA = 54mm D = 55mm Th = 2xM10	B+ M8, PL04 E = D	

DAN1322		14V	100A
OPEL			
Poly-VF 5 C = 58mm Mb = 1xØ12, 1xØ11	ØA = 54mm D = 55mm Th = 2xM10	B+ M8, PL04 E = D	

DAN1325		14V	150A
Poly-VF 6 C = 46mm Mb = 2xØ10.6	ØA = 54.3mm D = 43mm Th = 2xM10	B+ M8, PL18 E = D	

DAN1325		14V	150A
Poly-VF 6 C = 46mm Mb = 2xØ10.6	ØA = 54.3mm D = 43mm Th = 2xM10	B+ M8, PL18 E = D	

DAN1326		14V	150A
Poly-VF 7 C = 35mm Mb = 1xØ11, 1xØ10.5	ØA = 65mm D = 43mm Th = 1xM10	B+ M8, PL23	

DAN1326		14V	150A
Poly-VF 7 C = 35mm Mb = 1xØ11, 1xØ10.5	ØA = 65mm D = 43mm Th = 1xM10	B+ M8, PL23	

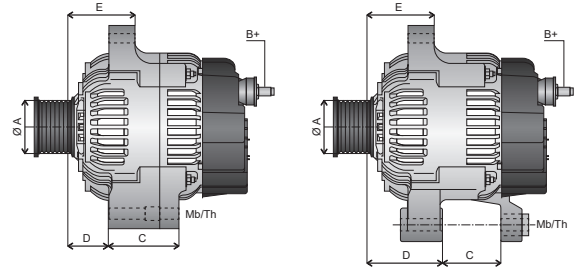

DAN1328		14V	140A
Poly-VF 6 C = 59mm Mb = 2xØ8.5	ØA = 56mm D = 40mm Th = 2xM8	B+ M8, PL25 E = D	

DAN1328		14V	140A
Poly-VF 6 C = 59mm Mb = 2xØ8.5	ØA = 56mm D = 40mm Th = 2xM8	B+ M8, PL25 E = D	

DAN1329		14V	150A
Poly-VF 5 C = 61mm Mb = 2xØ12.2	ØA = 54mm D = 52mm	B+ M8, D+ M5 E = 58mm	

DAN1329		14V	150A
Poly-VF 5 C = 61mm Mb = 2xØ12.2	ØA = 54mm D = 52mm	B+ M8, D+ M5 E = 58mm	

DAN1330		14V	150A
FIAT			
Poly-VF 6 C = 50mm Mb = 1xØ10, 1xØ8.5, 1xØ8	ØA = 56mm D = 62mm	B+ M8, D+ M5 E = D	

DAN1330		14V	150A
FIAT			
Poly-VF 6 C = 50mm Mb = 1xØ10, 1xØ8.5, 1xØ8	ØA = 56mm D = 62mm	B+ M8, D+ M5 E = D	

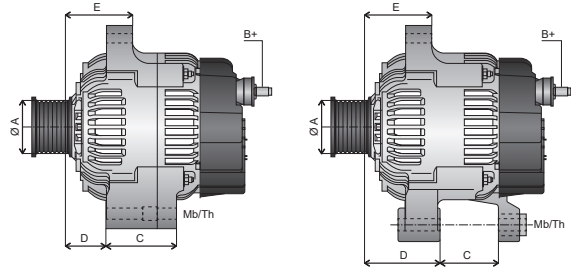

DAN1331		14V	140A
OPEL			
Poly-V 6 C = 55mm Mb = 1xØ9.2, 1xØ8.2, 1x(9.5x8.2)	ØA = 54mm D = 42mm	B+ M8, PL04 E = 67mm	

DAN1331		14V	140A
OPEL			
Poly-V 6 C = 55mm Mb = 1xØ9.2, 1xØ8.2, 1x(9.5x8.2)	ØA = 54mm D = 42mm	B+ M8, PL04 E = 67mm	

DAN1332		14V	150A
Poly-VF 5 C = 61mm Mb = 2xØ12.2	ØA = 54mm D = 52mm	B+ M8, PL19 E = 58mm	

DAN1332		14V	150A
Poly-VF 5 C = 61mm Mb = 2xØ12.2	ØA = 54mm D = 52mm	B+ M8, PL19 E = 58mm	

DAN1334		14V	140A
OPEL			
Poly-VF 5 C = 58mm Mb = 1xØ12, 1xØ11	ØA = 54mm D = 55mm Th = 2xM10	B+ M8, PL04 E = D	

DAN1334		14V	140A
OPEL			
Poly-VF 5 C = 58mm Mb = 1xØ12, 1xØ11	ØA = 54mm D = 55mm Th = 2xM10	B+ M8, PL04 E = D	

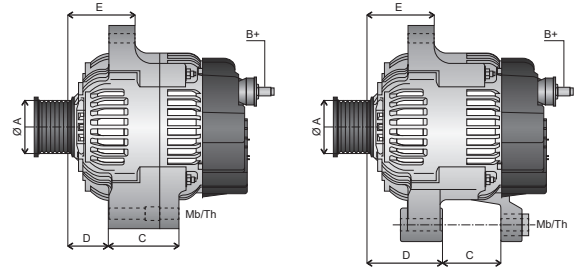

DAN1336		14V	90A
Poly-V 6 C = 46mm Mb = 1xØ10.1, 1xØ10.6	ØA = 54.3mm D = 43mm Th = 2xM10	B+ M8, PL01 E = D	

DAN1336		14V	90A
Poly-V 6 C = 46mm Mb = 1xØ10.1, 1xØ10.6	ØA = 54.3mm D = 43mm Th = 2xM10	B+ M8, PL01 E = D	

DAN1340		14V	100A
Poly-V 5 C = 57mm Mb = 2xØ11	ØA = 54mm D = 55mm Th = 2xM10	B+ M8, PL04 E = D	

DAN1340		14V	100A
Poly-V 5 C = 57mm Mb = 2xØ11	ØA = 54mm D = 55mm Th = 2xM10	B+ M8, PL04 E = D	

DAN1341		14V	100A
Poly-V 5 C = 57mm Mb = 2xØ10.2	ØA = 54mm D = 55mm Th = 2xM8	B+ M8, D+ M5 E = D	

DAN1341		14V	100A
Poly-V 5 C = 57mm Mb = 2xØ10.2	ØA = 54mm D = 55mm Th = 2xM8	B+ M8, D+ M5 E = D	

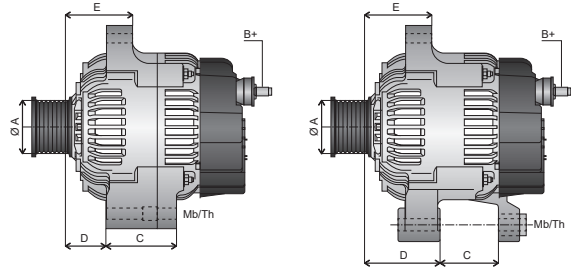

DAN1342		14V	100A
Poly-V 6	ØA = 50mm	B+ M8, D+ M5	
C = 57mm	D = 51mm	E = D	
Mb = 2xØ10.3	Th = 2xM8		

DAN1342		14V	100A
Poly-V 6	ØA = 50mm	B+ M8, D+ M5	
C = 57mm	D = 51mm	E = D	
Mb = 2xØ10.3	Th = 2xM8		

DAN1343		14V	70A
V 1	ØA = 67mm	B+ M8, D+ M5	
C = 57mm	D = 53mm	E = D	
Mb = 2xØ10.4	Th = 2xM8		

DAN1343		14V	70A
V 1	ØA = 67mm	B+ M8, D+ M5	
C = 57mm	D = 53mm	E = D	
Mb = 2xØ10.4	Th = 2xM8		

DAN1345		14V	130A
Poly-VF 5	ØA = 58mm	B+ M6, PL16	
C = 53mm	D = 41mm	E = 49mm	
Mb = 1xØ10.2, 1xØ9.7			

DAN1345		14V	130A
Poly-VF 5	ØA = 58mm	B+ M6, PL16	
C = 53mm	D = 41mm	E = 49mm	
Mb = 1xØ10.2, 1xØ9.7			

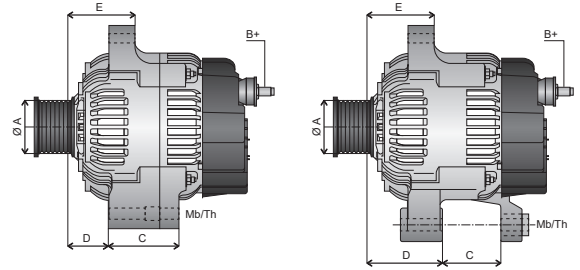

DAN1347		14V	80A
Poly-VF 7 C = 58mm Mb = 1xØ10.2	ØA = 58mm D = 38mm Th = 1xM8	B+ M6, PL16 E = 60mm	

DAN1347		14V	80A
Poly-VF 7 C = 58mm Mb = 1xØ10.2	ØA = 58mm D = 38mm Th = 1xM8	B+ M6, PL16 E = 60mm	

DAN1349		14V	70A
Poly-VF 7 C = 58mm Mb = 1xØ10.2	ØA = 58mm D = 38mm Th = 1xM8	B+ M6, PL16 E = 60mm	

DAN1349		14V	70A
Poly-VF 7 C = 58mm Mb = 1xØ10.2	ØA = 58mm D = 38mm Th = 1xM8	B+ M6, PL16 E = 60mm	

DAN1350		14V	150A
TOYOTA			
Poly-VF 7 C = 71mm Mb = 1xØ8.4, 1xØ10.4, 1x(11.2x8.8)	ØA = 58mm D = 24mm	B+ M6, PL17 E = 55mm	

DAN1350		14V	150A
TOYOTA			
Poly-VF 7 C = 71mm Mb = 1xØ8.4, 1xØ10.4, 1x(11.2x8.8)	ØA = 58mm D = 24mm	B+ M6, PL17 E = 55mm	

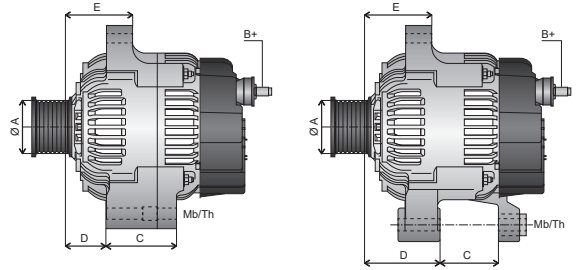

DAN1351		14V	100A
Poly-VF 7 C = 71mm Mb = 1xØ10.4, 1xØ8.4, 1x(11.2x8.8)	ØA = 58mm D = 24mm	B+ M6, PL16 E = 55mm	

DAN1351		14V	100A
Poly-VF 7 C = 71mm Mb = 1xØ10.4, 1xØ8.4, 1x(11.2x8.8)	ØA = 58mm D = 24mm	B+ M6, PL16 E = 55mm	

DAN1354		14V	150A
LEXUS			
Poly-VF 7 C = 33/36mm Mb = 2xØ11	ØA = 52.5mm D = 38mm Th = 1xM10, 1xM8	B+ M6, PL17 E = 33mm	

DAN1354		14V	150A
LEXUS			
Poly-VF 7 C = 33/36mm Mb = 2xØ11	ØA = 52.5mm D = 38mm Th = 1xM10, 1xM8	B+ M6, PL17 E = 33mm	

DAN1357		14V	75A
SUZUKI			
Poly-V 5 C = 58mm Mb = 1xØ10.2	ØA = 55mm D = 32mm Th = 1xM8	B+ M6, PL14 E = 48mm	

DAN1357		14V	75A
SUZUKI			
Poly-V 5 C = 58mm Mb = 1xØ10.2	ØA = 55mm D = 32mm Th = 1xM8	B+ M6, PL14 E = 48mm	

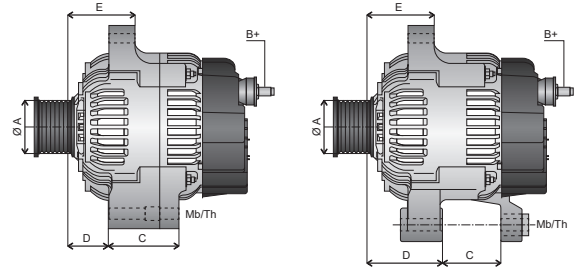

DAN1365		14V	90A
Poly-VF 6 C = 55mm Mb = 2xØ12.2, 1xØ10.8	ØA = 54mm D = 45mm	B+ M8, D+ M5 E = D	

DAN1365		14V	90A
Poly-VF 6 C = 55mm Mb = 2xØ12.2, 1xØ10.8	ØA = 54mm D = 45mm	B+ M8, D+ M5 E = D	

DAN1370		14V	105A
HONDA			
Poly-V 6 C = 39mm Mb = 1xØ9, 1xØ8.5	ØA = 60mm D = 46mm Th = 1xM8	B+ M6, PL23 E = 38mm	

DAN1370		14V	105A
HONDA			
Poly-V 6 C = 39mm Mb = 1xØ9, 1xØ8.5	ØA = 60mm D = 46mm Th = 1xM8	B+ M6, PL23 E = 38mm	

DAN1375		14V	105A
HONDA			
Poly-V 7 C = 46mm Mb = 1xØ9, 1xØ8.7, 1xØ8.2	ØA = 60mm D = 40mm	B+ M6, PL14 E = D	

DAN1375		14V	105A
HONDA			
Poly-V 7 C = 46mm Mb = 1xØ9, 1xØ8.7, 1xØ8.2	ØA = 60mm D = 40mm	B+ M6, PL14 E = D	

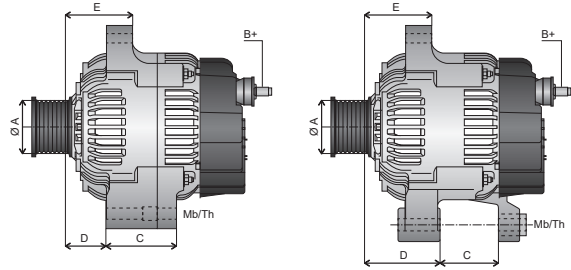

DAN1376		14V	105A
HONDA			
Poly-V 7 C = 35mm Mb = 1xØ11, 1xØ8.5	ØA = 60mm D = 43mm Th = 1xM10	B+ M6, PL14 E = 52mm	

DAN1376		14V	105A
HONDA			
Poly-V 7 C = 35mm Mb = 1xØ11, 1xØ8.5	ØA = 60mm D = 43mm Th = 1xM10	B+ M6, PL14 E = 52mm	

DAN1407		14V	120A
JAGUAR			
Poly-V 6 C = 58mm Mb = 1xØ10.5	ØA = 55mm D = 38mm Th = 1xM8	B+ M8, PL14 E = 60mm	

DAN1407		14V	120A
JAGUAR			
Poly-V 6 C = 58mm Mb = 1xØ10.5	ØA = 55mm D = 38mm Th = 1xM8	B+ M8, PL14 E = 60mm	

DAN1408		14V	120A
JAGUAR			
Poly-V 6 C = 74mm Mb = 1xØ14.7, 1xØ12.8, 1x(14x12.8)	ØA = 59mm D = 40mm	B+ M8, PL14 E = 46mm	

DAN1408		14V	120A
JAGUAR			
Poly-V 6 C = 74mm Mb = 1xØ14.7, 1xØ12.8, 1x(14x12.8)	ØA = 59mm D = 40mm	B+ M8, PL14 E = 46mm	

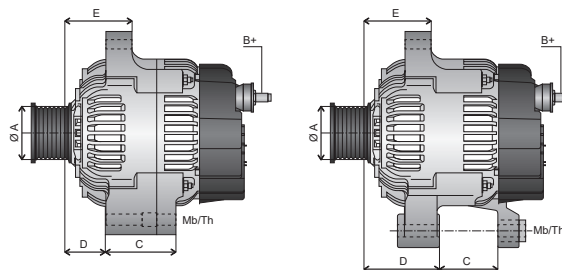

DAN1429		14V	120A
FIAT			
Poly-V 5 C = 50mm Mb = 3xØ8.5	ØA = 54mm D = 17mm	B+ M8, D+ M5 E = 67mm	

DAN1429		14V	120A
FIAT			
Poly-V 5 C = 50mm Mb = 3xØ8.5	ØA = 54mm D = 17mm	B+ M8, D+ M5 E = 67mm	

DAN1431		14V	150A
FIAT			
Poly-VF 6 C = 61mm Mb = 2xØ12.2	ØA = 54mm D = 52mm	B+ M8, D+ M5 E = 58mm	

DAN1431		14V	150A
FIAT			
Poly-VF 6 C = 61mm Mb = 2xØ12.2	ØA = 54mm D = 52mm	B+ M8, D+ M5 E = 58mm	

DAN1434		14V	100A
TOYOTA			
Poly-V 7 C = 45mm Mb = 1xØ11	ØA = 60mm D = 36mm Th = 1xM10, 1xM8	B+ M6, PL05 E = 74mm	

DAN1434		14V	100A
TOYOTA			
Poly-V 7 C = 45mm Mb = 1xØ11	ØA = 60mm D = 36mm Th = 1xM10, 1xM8	B+ M6, PL05 E = 74mm	

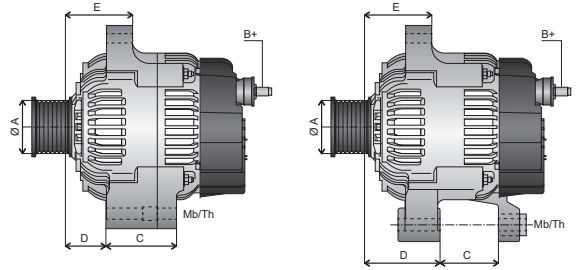

DAN1462		14V	180A
BMW			
Poly-V 6	ØA = 53.2mm	B+ M8, PL25	LIN
C = 76mm	D = 80mm	E = D	
Mb = 1xØ10.5, 1xØ10.2	Th = 1xM10		

DAN1462		14V	180A
BMW			
Poly-V 6	ØA = 53.2mm	B+ M8, PL25	LIN
C = 76mm	D = 80mm	E = D	
Mb = 1xØ10.5, 1xØ10.2	Th = 1xM10		

DAN1464		14V	180A
BMW			
Poly-V 6	ØA = 48.3mm	B+ M8, PL25	LIN
C = 76mm	D = 58mm	E = D	
Mb = 1xØ10.5, 1xØ10.2	Th = 1xM10		

DAN1464		14V	180A
BMW			
Poly-V 6	ØA = 48.3mm	B+ M8, PL25	LIN
C = 76mm	D = 58mm	E = D	
Mb = 1xØ10.5, 1xØ10.2	Th = 1xM10		

DAN1466		14V	190A
BMW			
Poly-V 6	ØA = 53.2mm	B+ M8, PL25	LIN
C = 76mm	D = 80mm	E = D	
Mb = 1xØ10.5, 1xØ10.2	Th = 1xM10		

DAN1466		14V	190A
BMW			
Poly-V 6	ØA = 53.2mm	B+ M8, PL25	LIN
C = 76mm	D = 80mm	E = D	
Mb = 1xØ10.5, 1xØ10.2	Th = 1xM10		

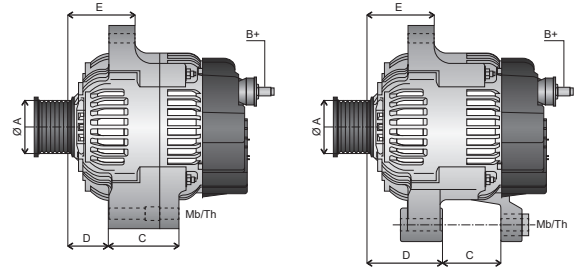

DAN1468 14V 210A

BMW

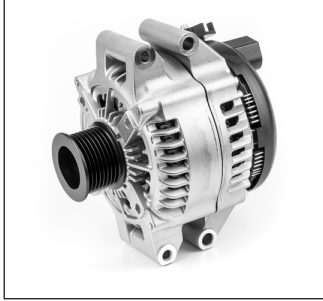

Poly-V 8 C = 41mm Mb = 2xØ10.6, 1xØ8, 1x(9.5x8)	ØA = 51.2mm D = 30mm	B+ M8, PL25 E = D
---	-------------------------	--------------------------

DAN1468 14V 210A

BMW



Poly-V 8 C = 41mm Mb = 2xØ10.6, 1xØ8, 1x(9.5x8)	ØA = 51.2mm D = 30mm	B+ M8, PL25 E = D
---	-------------------------	--------------------------

DAN1469 14V 210A

BMW



Poly-V 6 C = 76mm Mb = 1xØ10.5, 1xØ10.2	ØA = 48.3mm D = 58mm Th = 1xM10	B+ M8, PL25 E = D
---	---------------------------------------	--------------------------

DAN1469 14V 210A

BMW



Poly-V 6 C = 76mm Mb = 1xØ10.5, 1xØ10.2	ØA = 48.3mm D = 58mm Th = 1xM10	B+ M8, PL25 E = D
---	---------------------------------------	--------------------------

DAN1471 14V 220A

BMW



Poly-V 6 C = 76mm Mb = 1xØ10.5, 1xØ10.2	ØA = 53.2mm D = 80mm Th = 1xM10	B+ M8, PL25 E = D
---	---------------------------------------	--------------------------

DAN1471 14V 220A

BMW



Poly-V 6 C = 76mm Mb = 1xØ10.5, 1xØ10.2	ØA = 53.2mm D = 80mm Th = 1xM10	B+ M8, PL25 E = D
---	---------------------------------------	--------------------------

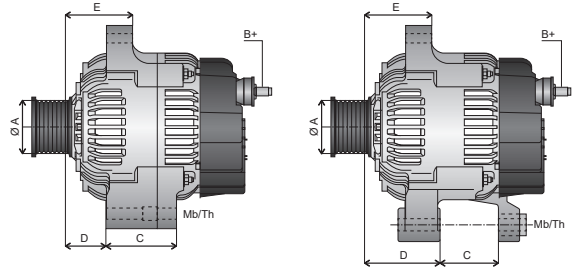

DAN1481			14V	130A
TOYOTA				
Poly-VF 7	$\text{ØA} = 58\text{mm}$	B+ M6, PL17		
C = 58mm	D = 38mm	E = 60mm		
Mb = 1xØ10.2	Th = 1xM8			

DAN1481			14V	130A
TOYOTA				
Poly-VF 7	$\text{ØA} = 58\text{mm}$	B+ M6, PL17		
C = 58mm	D = 38mm	E = 60mm		
Mb = 1xØ10.2	Th = 1xM8			

DAN1482			14V	150A
TOYOTA				
Poly-VF 7	$\text{ØA} = 55\text{mm}$	B+ M6, PL17		
C = 45mm	D = 36mm	E = 74mm		
Mb = 1xØ11	Th = 1xM10, 1xM8			

DAN1482			14V	150A
TOYOTA				
Poly-VF 7	$\text{ØA} = 55\text{mm}$	B+ M6, PL17		
C = 45mm	D = 36mm	E = 74mm		
Mb = 1xØ11	Th = 1xM10, 1xM8			

DAN1483			14V	150A
TOYOTA				
Poly-VF 7	$\text{ØA} = 52.5\text{mm}$	B+ M6, PL16		
C = 33/36mm	D = 38mm	E = 33mm		
Mb = 2xØ11	Th = 1xM10, 1xM8			

DAN1483			14V	150A
TOYOTA				
Poly-VF 7	$\text{ØA} = 52.5\text{mm}$	B+ M6, PL16		
C = 33/36mm	D = 38mm	E = 33mm		
Mb = 2xØ11	Th = 1xM10, 1xM8			

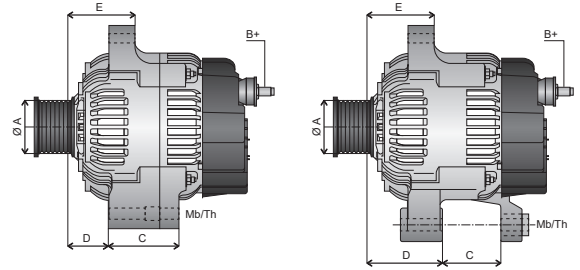

DAN1484		14V	150A
TOYOTA			
Poly-VF 7	ØA = 52.5mm	B+ M6, PL16	
C = 33/36mm	D = 38mm	E = 33mm	
Mb = 2xØ11	Th = 1xM10, 1xM8		

DAN1484		14V	150A
TOYOTA			
Poly-VF 7	ØA = 52.5mm	B+ M6, PL16	
C = 33/36mm	D = 38mm	E = 33mm	
Mb = 2xØ11	Th = 1xM10, 1xM8		

DAN1487		14V	90A
ISUZU			
Poly-V 7	ØA = 62.5mm	B+ M8, PL28	
C = 80mm	D = 43mm	E = 56mm	
Mb = 1xØ10.5, 1xØ10.2	Th = 1xM8		

DAN1487		14V	90A
ISUZU			
Poly-V 7	ØA = 62.5mm	B+ M8, PL28	
C = 80mm	D = 43mm	E = 56mm	
Mb = 1xØ10.5, 1xØ10.2	Th = 1xM8		

DAN1488		14V	90A
ISUZU			
Poly-V 6	ØA = 57.5mm	B+ M6, PL07	
C = 58mm	D = 34mm	E = 50mm	
Mb = 1xØ10.2	Th = 1xM8		

DAN1488		14V	90A
ISUZU			
Poly-V 6	ØA = 57.5mm	B+ M6, PL07	
C = 58mm	D = 34mm	E = 50mm	
Mb = 1xØ10.2	Th = 1xM8		

Starters & Alternators | Memo

DENSO Cross Reference Chart



Starters & Alternators

Cross Reference Chart

ALFA ROMEO	DENSO
46430531	DAN1037
46454211	DSN579
46554400	DAN502
46782213	DAN501
46809068	DAN502
50500728	DAN936
50502479	DAN935
51700675	DAN998
51714791	DAN519
51718502	DAN1004
51727333	DAN1005
51734825	DAN936
51764265	DAN994
51787196	DAN999
51787208	DAN996
51787209	DAN996
51788658	DAN993
51793678	DAN995
51808560	DAN1329
51808561	DAN1123
51820624	DAN1084
51829380	DSN975
51854103	DAN997
51854898	DAN1000
51854901	DAN994
51854902	DAN995
51854903	DAN993
51854907	DAN1001
51854912	DAN997
51854914	DAN996
51854915	DAN996
51859037	DAN517
51859038	DAN519
51859041	DAN999
51859042	DAN998
51859043	DAN1004
51859044	DAN1005
51872564	DSN975
51874105	DAN1078
51880175	DAN1086
51884239	DAN1332
51884351	DAN1121
51884886	DAN1066
51907673	DAN1145
51929089	DAN1146
51931432	DAN1329
51943777	DAN1123
52003508	DAN1000
52003623	DAN1123
60699935	DAN935
60812814	DAN1037
60812988	DAN1037
60812989	DAN1037
60815944	DAN502
60815953	DAN501
60816045	DAN501
60816047	DAN1037
60816488	DAN1037
60816557	DAN501
60816954	DAN502
71773262	DAN502
71773263	DAN513
73501591	DAN1062
73503235	DAN513

AUDI	DENSO
02B 911 023 D	DSN3016
02B 911 023 J	DSN3016
02B 911 023 L	DSN3016
02B 911 023 N	DSN3016
02E 911 022 C	DSN1460
02E 911 022 CX	DSN1460
02E 911 023 H	DSN3008
02E 911 023 HX	DSN3008
02E 911 023 M	DSN1464
02E 911 023 MX	DSN1464
02E 911 023 Q	DSN1460
02E 911 023 QX	DSN1460
02E 911 023 T	DSN1460
02E 911 023 TX	DSN1460
02E 911 024 B	DSN1464

AUDI	DENSO
02E 911 024 BX	DSN1464
02E 911 024 C	DSN1460
02E 911 024 CX	DSN1460
02E 911 024 D	DSN1464
02E 911 024 DX	DSN1464
02E 911 024 H	DSN1460
02E 911 024 HX	DSN1460
02E 911 024 J	DSN1460
02E 911 024 JX	DSN1460
02E 911 024 M	DSN1464
02E 911 024 MX	DSN1464
02M 911 021 B	DSN3005
02M 911 021 BX	DSN3005
02M 911 021 G	DSN1468
02M 911 021 GX	DSN1468
02M 911 021 P	DSN1461
02M 911 021 PX	DSN1461
02M 911 023 G	DSN3005
02M 911 023 GX	DSN3005
02M 911 023 M	DSN3005
02M 911 023 MX	DSN3005
02M 911 024 B	DSN1461
02M 911 024 BX	DSN1461
02M 911 024 C	DSN1461
02M 911 024 CX	DSN1461
02M 911 024 G	DSN1461
02M 911 024 GX	DSN1461
02M 911 024 H	DSN962
02M 911 024 HX	DSN962
02M 911 024 J	DSN1468
02M 911 024 JX	DSN1468
02M 911 024 Q	DSN1468
02M 911 024 QX	DSN1468
02M 911 024 S	DSN1461
02M 911 024 SX	DSN1461
02T 911 023 R	DSN3006
02T 911 023 RX	DSN3006
02T 911 023 S	DSN3006
02T 911 024 A	DSN3006
02T 911 024 B	DSN3006
02T 911 024 C	DSN3006
02T 911 024 K	DSN3006
02T 911 024 N	DSN3006
02Z 911 021 C	DSN1462
02Z 911 021 CX	DSN1462
02Z 911 021 K	DSN1462
02Z 911 021 KX	DSN1462
02Z 911 023 F	DSN3007
02Z 911 023 FX	DSN3007
02Z 911 023 H	DSN3007
02Z 911 023 HX	DSN3007
02Z 911 023 N	DSN963
02Z 911 023 NX	DSN963
02Z 911 023 P	DSN963
02Z 911 023 PX	DSN963
02Z 911 023 S	DSN1462
02Z 911 023 SX	DSN1462
02Z 911 024	DSN1466
02Z 911 024 A	DSN1462
02Z 911 024 AX	DSN1462
02Z 911 024 B	DSN1462
02Z 911 024 BX	DSN1462
02Z 911 024 H	DSN1462
02Z 911 024 HX	DSN1462
02Z 911 024 J	DSN3007
02Z 911 024 JX	DSN3007
02Z 911 024 K	DSN963
02Z 911 024 KX	DSN963
02Z 911 024 L	DSN1462
02Z 911 024 LX	DSN1462
02Z 911 024 X	DSN1466
03L 903 023	DAN1328
03L 903 023 A	DAN1328
03L 903 023 X	DAN1328
03L 903 024 M	DAN1328
03L 903 024 MX	DAN1328
03L 911 021	DSN994
03L 911 021 C	DSN994
03L 911 021 CX	DSN994
03L 911 021 E	DSN994

AUDI	DENSO
03L 911 021 EX	DSN994
03L 911 021 G	DSN994
03L 911 021 GX	DSN994
03L 911 021 H	DSN994
03L 911 021 HX	DSN994
03L 911 024	DSN994
03L 911 024 A	DSN994
03L 911 024 B	DSN994
03L 911 024 C	DSN994
059 911 021 G	DSN1203
059 911 021 H	DSN1203
059 911 021 HX	DSN1203
059 911 021 K	DSN1203
059 911 021 KX	DSN1203
059 911 024 K	DSN965
059 911 024 KX	DSN965
059 911 024 P	DSN1203
059 911 024 PX	DSN1203
059 911 024 Q	DSN1203
068 911 023 P	DSN3015
068 911 023 R	DSN3015
068 911 023 S	DSN3015
068 911 024 B	DSN3015
068 911 024 C	DSN3015
068 911 024 E	DSN3015
068 911 024 F	DSN3015
068 911 024 G	DSN3015
06E 911 021 D	DSN1204
06E 911 021 DX	DSN1204
06E 911 021 F	DSN1204
06E 911 021 FX	DSN1204
06E 911 024	DSN1204
06E 911 024 A	DSN1204
06E 911 024 AX	DSN1204
06E 911 024 B	DSN1204
06E 911 024 X	DSN1204
06H 911 021	DSN1201
06H 911 021 D	DSN1201
06H 911 021 DX	DSN1201
06H 911 021 X	DSN1201
06H 911 024	DSN1201
06H 911 024 A	DSN1201
06H 911 024 AX	DSN1201
06H 911 024 B	DSN1201
06H 911 024 BX	DSN1201
06H 911 024 C	DSN1201
06H 911 024 X	DSN1201
079 911 024	DSN1204
079 911 024 X	DSN1204
09A 911 023	DSN957
09A 911 023 A	DSN958
09A 911 023 B	DSN958
09A 911 023 BX	DSN958
09A 911 023 X	DSN957
0AH 911 023 F	DSN964
0AH 911 023 FX	DSN1467
0AH 911 023 GX	DSN1467
0AM 911 021 B	DSN1463
0AM 911 021 E	DSN1463
0AM 911 021 EX	DSN1463
0AM 911 023 G	DSN1463
0AM 911 023 GX	DSN1463
0AM 911 023 H	DSN1463
0AM 911 023 HX	DSN1463
0AM 911 023 J	DSN1463
0AM 911 023 JX	DSN1463
0AM 911 023 M	DSN1463
0AM 911 023 MX	DSN1463
0AM 911 023 N	DSN1465
0AM 911 023 NX	DSN1465
0AM 911 023 R	DSN1465
0AM 911 023 RX	DSN1465
0AM 911 024 A	DSN1465
0AM 911 024 AX	DSN1465

BMW	DENSO
12317605060	DAN1125

BMW	DENSO
12317605061	DAN1127
12317605478	DAN1126
12317605479	DAN1127
12317605480	DAN1126
12317606628	DAN1138
12317610260	DAN1125
12317616119	DAN1135
12317616120	DAN1137
12317616121	DAN1135
12317616122	DAN1137
12317616126	DAN1138
12317626153	DAN1133
12317626155	DAN1133
12317640132	DAN1464
12317640875	DAN1464
12317646814	DAN1469
12317646815	DAN1469
12317848603	DAN1468
12317853781	DAN1468
12318645325	DAN1462
12318645326	DAN1466
12318645329	DAN1471
12318648045	DAN1462
12318648046	DAN1466
12318648047	DAN1471
12412344243	DSN1375
12412354701	DSN1375
12417521116	DSN1375
12417521122	DSN1375
12417521123	DSN1375
12417526236	DSN1375
12417556131	DSN1377
12417566337	DSN1476
12417577257	DSN1377
12417579152	DSN1476
12417579155	DSN1375
12417579156	DSN1375
12417594292	DSN1375
12417612815	DSN1378
12417616500	DSN1375
12417616502	DSN1375
12417618620	DSN1378
12417631558	DSN1376
12417631559	DSN1376
2344243	DSN1375
2354701	DSN1375
7521116	DSN1375
7521122	DSN1375
7521123	DSN1375
7526236	DSN1375
7556131	DSN1377
7566337	DSN1476
7577257	DSN1377
7579152	DSN1476
7579155	DSN1375
7579156	DSN1375
7594292	DSN1375
7605060	DAN1125
7605061	DAN1127
7605478	DAN1126
7605479	DAN1127
7605480	DAN1126
7606628	DAN1138
7610260	DAN1125
7612815	DSN1378
7616119	DAN1135
7616120	DAN1137
7616121	DAN1135
7616122	DAN1137
7616126	DAN1138
7616500	DSN1375
7616502	DSN1375
7618620	DSN1378
7626153	DAN1133
7626155	DAN1133
7631558	DSN1376
7631559	DSN1376
7640132	DAN1464
7640875	DAN1464
7646814	DAN1469
7646815	DAN1469

Starters & Alternators | Cross Reference Chart

BMW	DENSO
7848603	DAN1468
7853781	DAN1468
8645325	DAN1462
8645326	DAN1466
8645329	DAN1471
8648045	DAN1462
8648046	DAN1466
8648047	DAN1471

CHEVROLET	DENSO
25 182 244	DSN3009
25 186 107	DSN3009
9200962	DSN3017
93 171 526	DSN3017
93 176 034	DSN3017
96 952 006	DSN3009

CHRYSLER	DENSO
51874105	DAN1078

CITROEN	DENSO
16 080 646 80	DSN1368
1608066080	DAN1071
1608858080	DAN997
1608858180	DAN1086
1610048280	DAN1071
1610815380	DAN1325
1611206880	DSN3013
1614379980	DSN3013
1617116680	DAN997
5702A4	DAN515
5702AQ	DAN515
5702C8	DAN515
5702C9	DAN515
5702E8	DAN1336
5702J1	DAN1035
5702J2	DAN1036
5702K1	DAN1336
5702K2	DAN1336
5702L0	DAN1035
5702L1	DAN1036
57055A	DAN1336
57055B	DAN1336
57055P	DAN1063
57055Q	DAN1063
57055T	DAN1336
57056C	DAN515
57056E	DAN515
57056M	DAN1063
57056U	DAN1063
57057G	DAN1063
57057H	DAN1063
5705AP	DAN515
5705AW	DAN515
5705AZ	DAN1336
5705EL	DAN1063
5705EN	DAN515
5705EP	DAN515
5705FA	DAN515
5705FC	DAN1336
5705GF	DAN1063
5705GG	DAN1063
5705GJ	DAN1063
5705GK	DAN1063
5705GN	DAN1336
5705GP	DAN1336
5705GQ	DAN1336
5705GZ	DAN515
5705KH	DAN1035
5705KJ	DAN1036
5705KX	DAN1336
5705KY	DAN1336
5705KZ	DAN515
5705NN	DAN1035
5705NP	DAN1036
5705NY	DAN1001
5802AH	DSN942
5802AP	DSN942
5802AQ	DSN3014
5802AS	DSN3012
5802AX	DSN942

CITROEN	DENSO
5802AY	DSN3013
5802CY	DSN3004
5802EE	DSN3013
5802FA	DSN3014
5802FC	DSN3012
5802FE	DSN942
5802FF	DSN942
5802FQ	DSN3013
5802V8	DSN3004
5802W5	DSN3004
5802W8	DSN3004
5802Z0	DSN3013
96 715 308 80	DSN1368
96 884 773 80	DSN1368
9633782580	DAN1336
9635557580	DAN1063
9635557780	DAN1063
9636204480	DAN1336
9637856880	DAN1063
9638275580	DAN1336
9638275780	DAN1336
9638275880	DAN1336
9638275980	DAN1336
9638276180	DAN1063
9638276280	DAN1063
9638525380	DSN942
9638543680	DAN515
9638543780	DAN515
9638544180	DAN515
9638544280	DAN515
9638544480	DAN515
9641398480	DAN1336
9641398680	DAN1336
9641727480	DAN1063
9642879480	DAN515
9642879680	DAN515
9642879780	DAN515
9642879980	DAN1336
9642880080	DAN1336
9642880180	DAN1336
9648111680	DSN3004
9649448380	DSN942
9649611480	DAN1336
9649611580	DAN1336
9649611680	DAN515
9649611780	DAN515
9649611880	DAN515
9656299480	DSN3004
9656956080	DAN1336
9656956280	DAN515
9656956380	DAN1336
9664883080	DSN942
9664883081	DSN942
9665577480	DAN515
9665577580	DAN1336
9665577780	DAN1336
9675092580	DSN3012
9678178280	DAN1325
9688237380	DAN1071
9806007480	DAN1071

DAEWOO	DENSO
96550792	DSN3009

DAIHATSU	DENSO
27060-87501	DAN968
27060-87501-000	DAN968
27060-87606	DAN969
27060-87606-000	DAN969
27060-87607	DAN969
27060-87607-000	DAN969
27060-87727	DAN970
27060-87727-000	DAN970
27060-87728	DAN972
27060-87728-000	DAN972
27060-87729	DAN971
27060-87729-000	DAN971
27060-87730	DAN972
27060-87730-000	DAN972
27060-97202	DAN973
27060-97202-000	DAN973

DAIHATSU	DENSO
27060-97203	DAN974
27060-97203-000	DAN974
27060-97212	DAN975
27060-97212-000	DAN975
27060-97401	DAN976
27060-97401-000	DAN976
27060-97502	DAN978
27060-97502-000	DAN978
27060-B1030	DAN979
27060-B1030-000	DAN979
27060-B1050	DAN980
27060-B1050-000	DAN980

FERRARI	DENSO
000180169	DSN1457
180169	DSN1457

FIAT	DENSO
1347058080	DSN3014
1349920080	DSN3013
46231746	DAN615
46406973	DSN579
46406974	DSN579
46407646	DAN630
46407647	DAN629
46412681	DAN1037
46416343	DAN629
46417006	DSN577
46420106	DSN579
46420961	DAN629
46420966	DAN628
46425517	DAN628
46430524	DAN630
46430528	DAN1037
46430529	DAN1140
46430530	DAN1140
46430531	DAN1037
46430533	DAN632
46430784	DSN3018
46434933	DAN628
46436507	DAN629
46437413	DAN629
46442044	DSN579
46445094	DAN615
46445658	DAN1140
46447117	DAN1140
46448433	DAN1037
46448434	DAN1037
46454211	DSN579
46468696	DSN579
46473784	DSN3018
46473787	DSN577
46475793	DSN577
46478224	DSN577
46478945	DSN3018
46516740	DAN629
46540294	DAN628
46542889	DAN517
46543023	DAN641
46544329	DAN501
46544330	DAN1037
46554400	DAN502
46554404	DAN519
46554408	DAN520
46559015	DAN630
46736968	DAN631
46748353	DAN502
46748357	DAN519
46758245	DAN629
46758246	DAN599
46763532	DAN1037
46763533	DAN520
46765835	DAN632
46765836	DAN1140
46765838	DAN501
46769369	DAN1140
46774415	DSN577
46774421	DAN1037
46774430	DAN520
46782213	DAN501
46782218	DAN640

FIAT	DENSO
46800159	DSN3018
46809067	DAN641
46809068	DAN502
468223543	DSN3018
46823543	DSN3018
46823546	DAN1003
46823547	DAN1002
46835095	DAN997
46843091	DAN517
50500728	DAN936
50502479	DAN935
51700675	DAN998
51709131	DAN519
51709132	DAN599
51709133	DAN517
51714791	DAN519
51714792	DAN599
51714794	DAN517
51718494	DAN1001
51718499	DAN1002
51718502	DAN1004
51727333	DAN1005
51727338	DAN1365
51734825	DAN936
51764265	DAN994
51779086	DSN3013
51782321	DSN3018
51784844	DAN1002
51784845	DAN1002
51784846	DAN997
51784847	DAN1003
51784848	DAN1001
51787196	DAN999
51787208	DAN996
51787209	DAN996
51787210	DAN1141
51788658	DAN993
51792276	DAN1001
51793678	DAN995
51805799	DAN1002
51805800	DAN1002
51805801	DAN997
51805803	DAN1003
51805804	DAN1001
51808560	DAN1329
51808561	DAN1123
51810284	DAN1001
51820622	DAN1083
51820623	DAN1147
51820624	DAN1084
51829380	DSN975
51829382	DAN1141
51829383	DAN997
51832953	DSN3018
51832954	DSN3018
51832958	DSN3013
51837747	DAN993
51854103	DAN997
51854898	DAN1000
51854901	DAN994
51854902	DAN995
51854903	DAN993
51854905	DAN1003
51854906	DAN1001
51854907	DAN1001
51854909	DAN1002
51854910	DAN1002
51854911	DAN997
51854912	DAN997
51854914	DAN996
51854915	DAN996
51854916	DAN1141
51854917	DAN1083
51855875	DAN1141
51859037	DAN517
51859038	DAN519
51859039	DAN599
51859041	DAN999
51859042	DAN998
51859043	DAN1004
51859044	DAN1005

Starters & Alternators

Cross Reference Chart

FIAT	DENSO
51859052	DAN520
51859053	DAN501
51859058	DAN1365
51859061	DAN1085
51872564	DSN975
51874104	DAN1078
51874105	DAN1078
51880173	DAN1086
51880175	DAN1086
51884239	DAN1332
51884351	DAN1121
51884886	DAN1066
51891463	DSN1301
51907673	DAN1145
51916020	DAN1311
51922437	DAN1089
51927505	DAN1310
51928308	DAN1330
51929089	DAN1146
51929094	DAN1078
51929095	DAN1078
51931432	DAN1329
51938439	DSN975
51943777	DAN1123
51944892	DAN1431
51944893	DAN1429
51984058	DAN1086
51984358	DSN3013
51993603	DAN1086
52003508	DAN1000
52003523	DAN1141
52003524	DAN1141
52003615	DAN1147
52003618	DAN1330
52003620	DAN1311
52003623	DAN1123
55185075	DAN996
55185076	DAN996
55192482	DSN3018
55195029	DSN3018
55195211	DSN3018
551952110	DSN3018
55195967	DSN3014
55779086	DSN3013
55832954	DSN3018
5895033	DAN630
5895034	DAN629
60620761	DSN579
60699935	DAN935
60812535	DAN1140
60812583	DAN632
60812713	DAN1037
60812814	DAN1037
60812988	DAN1037
60812989	DAN1037
60814911	DSN3018
60815944	DAN502
60815953	DAN501
60816045	DAN501
60816046	DAN1140
60816047	DAN1037
60816083	DSN3018
60816173	DAN1140
60816488	DAN1037
60816557	DAN501
60816760	DAN641
60816954	DAN502
60817002	DSN3018
71721172	DAN1037
71721230	DSN577
71721258	DSN577
71722349	DSN3018
71723039	DAN1002
71739603	DAN632
71746669	DSN3018
71746673	DAN1062
71747925	DAN1336
71750297	DAN1062
71773260	DAN632
71773261	DAN1140
71773262	DAN502

FIAT	DENSO
71773263	DAN513
71782384	DSN3018
71784031	DAN998
71789267	DSN3018
71789529	DSN3014
71789745	DSN3013
71794169	DSN3018
71794196	DSN3013
71794211	DAN998
71794523	DAN1002
73501591	DAN1062
73503235	DAN513
7634289	DAN615
7697863	DAN615
7697870	DAN615
7769840	DAN628
7770084	DAN628
7779820	DAN630
7779821	DAN629
7781075	DAN632
7782188	DAN1140
7782314	DAN1140
7782315	DAN1140
7798011	DAN628
91600759	DAN630
91600760	DAN629
91600762	DAN629
95681447	DSN3012
9638275380	DAN1336
9638275480	DAN1336
9642879980	DAN1336
9649611380	DAN1336
9658144780	DSN3012
9675092580	DSN3012
K1347058080	DSN3014
K1349920080	DSN3013
K9658144780	DSN3012
K9675092580	DSN3012

FORD	DENSO
1001869	DAN047
1011331	DSN3001
1015821	DAN047
1018883	DSN3001
1019852	DSN3003
1027772	DSN3003
1030151	DSN3003
1031496	DAN562
1032139	DAN047
1033781	DSN3003
1053656	DAN504
1063999	DSN3001
1064000	DSN3001
1066047	DAN047
1066407	DAN047
1067622	DSN3003
1070804	DAN562
1070806	DAN588
1071383	DAN047
1073089	DAN562
1073090	DAN588
1074633	DAN504
1079312	DAN1124
1088649	DSN3001
1090085	DAN588
1092115	DSN3001
1092117	DSN3003
1097304	DAN562
1097306	DAN1124
1107444	DAN504
1107446	DAN047
1111967	DAN588
1116389	DSN3001
1126051	DAN1124
1126052	DAN562
1126499	DAN588
1127000	DAN562
1127001	DAN588
1136152	DAN047
1136390	DAN588
1138231	DAN1124

FORD	DENSO
1140760	DSN3001
1144182	DAN1124
1144183	DAN1124
1144185	DAN588
1144197	DAN588
1147309	DSN3001
1149703	DSN3002
1197235	DSN3001
1201206	DAN1124
1215762	DAN588
1215770	DAN562
1215771	DAN588
1219711	DAN1124
1221059	DAN1124
1229258	DAN1119
1229259	DAN930
1237323	DSN3001
1255711	DAN930
1255712	DAN1119
1256552	DAN1016
1301377	DAN1124
1301496	DAN562
1301511	DAN588
1301530	DAN562
1305962	DAN588
1306851	DAN588
1307487	DAN1124
1307578	DSN3001
1309581	DSN3002
1322573	DAN588
1322879	DAN1023
1342191	DAN588
1352431	DAN932
1352858	DAN1041
1353886	DAN1041
1361258	DAN588
1361259	DAN588
1365665	DSN3001
1372739	DSN3012
1374085	DAN1059
1385378	DSN3012
1387219	DAN931
1406095	DAN047
1416207	DSN3003
1416226	DSN3003
1416231	DSN3001
1416236	DSN3003
1426014	DAN588
1450641	DAN1124
1464564	DAN582
1473072	DSN3001
1477737	DAN1119
1477738	DAN930
1477739	DAN933
1477740	DAN932
1496231	DAN582
1511220	DAN588
1530298	DAN1023
1530299	DAN1016
1535268	DSN3001
1535294	DAN931
1535436	DAN998
1535437	DAN519
1539686	DSN3001
1543764	DAN1041
1564732	DSN3002
1571296	DAN1003
157297	DAN1002
1574338	DSN3012
1575034	DSN3001
1633079	DAN934
1669558	DSN3012
1671515	DSN3001
1673520	DAN998
1673521	DAN519
1684865	DAN1059
1692417	DAN1119
1704085	DAN1118
1705007	DAN1001
1705008	DAN997
1705483	DAN1004

FORD	DENSO
1705484	DAN599
1707062	DAN1139
1708322	DAN930
1708383	DAN932
1708472	DAN588
1709189	DSN3012
1719535	DAN1005
1719539	DAN999
1732742	DSN3001
1740947	DSN3012
1748620	DAN1023
1748625	DAN1016
1748630	DAN930
1748637	DAN588
1748650	DSN3012
1757293	DAN582
1757296	DAN1059
1757315	DAN932
1764816	DAN1073
1781479	DAN1313
1795985	DAN1312
1821291	DAN1074
1871851	DSN3002
1903127	DSN3001
1M5T-10300-BA	DAN1124
1M5T-10300-BB	DAN1124
1M5T-10300-BC	DAN1124
1M5T-10300-BD	DAN1124
2M5T-10300-AB	DAN562
2M5T-10300-AC	DAN562
2M5T-10300-AD	DAN562
2S6U-11000-CA	DSN3001
2S6U-11000-CB	DSN3001
2S6U-11000-CC	DSN3001
2S6U-11000-DA	DSN3002
2S6U-11000-DB	DSN3002
2S6U-11000-DC	DSN3002
3M5T-10300-JC	DAN1059
3M5T-10300-JD	DAN1059
3M5T-10300-KA	DAN1041
3M5T-10300-KB	DAN1041
3M5T-10300-KC	DAN1041
3M5T-10300-LC	DAN1023
3M5T-10300-LD	DAN1023
3M5T-10300-NB	DAN934
3M5T-10300-NC	DAN934
3M5T-10300-PB	DAN1119
3M5T-10300-PC	DAN1119
3M5T-10300-PD	DAN1119
3M5T-10300-PE	DAN1119
3M5T-10300-SC	DAN1059
3M5T-10300-SD	DAN1059
3M5T-10300-VB	DAN1016
3M5T-10300-VC	DAN1016
3M5T-10300-VD	DAN1016
3M5T-10300-XB	DAN931
3M5T-10300-XC	DAN931
3M5T-10300-XD	DAN931
3M5T-10300-YB	DAN930
3M5T-10300-YC	DAN930
3M5T-10300-YD	DAN930
3M5T-10300-YE	DAN930
3N11-10300-AB	DAN588
3N11-10300-AC	DAN588
3N11-10300-AD	DAN588
3N11-10300-AE	DAN588
3N11-10300-AF	DAN588
3N11-10300-AG	DAN588
4M5T-10300-BB	DAN933
4M5T-10300-BC	DAN933
4M5T-10300-BD	DAN933
4M5T-10300-LA	DAN582
4M5T-10300-LB	DAN582
4M5T-10300-LC	DAN582
4M5T-10300-UB	DAN932
4M5T-10300-UC	DAN932
4M5T-10300-UD	DAN932
5026722	DAN504
5030589	DAN504
6C1T 11000 AA	DSN3012
6C1T 11000 AB	DSN3012

Starters & Alternators

Cross Reference Chart

FORD	DENSO
6C1T 11000 AC	DSN3012
6C1T 11000 AD	DSN3012
6C1T 11000 AE	DSN3012
6C1T 11000 AF	DSN3012
7G9N-11000-AB	DSN3001
7G9N-11000-AC	DSN3001
7G9N-11000-AD	DSN3001
7H12 11002 AA	DSN3012
7H12 11002 AB	DSN3012
7H12 11002 AC	DSN3012
8M5T-10300-PA	DAN1139
8M5T-10300-PB	DAN1139
8M5T-10300-YA	DAN1118
8M5T-10300-YB	DAN1118
8V21-11000-BB	DSN3001
8V21-11000-BC	DSN3001
8V21-11000-BD	DSN3001
8V21-11000-BE	DSN3001
91FF-10300-JA	DAN504
91FF-10300-JB	DAN504
95FB-11000-BD	DSN3003
95FF-10300-AA	DAN504
95FF-10300-AB	DAN504
95FF-10300-AC	DAN504
95FF-10300-AD	DAN504
96FB-11000-KA	DSN3001
96FB-11000-KB	DSN3001
96FB-11000-KC	DSN3001
96FB-11000-KD	DSN3001
96FB-11000-MD	DSN3003
96FB-11000-ME	DSN3003
96FF-10300-DB	DAN047
96FF-10300-DC	DAN047
97AB-10300-AA	DAN047
97AB-10300-AB	DAN047
97AB-10300-AC	DAN047
97AB-10300-AD	DAN047
97AB-10300-AE	DAN047
97KB-11000-AA	DSN3003
97KB-11000-AB	DSN3003
97KB-11000-AC	DSN3003
98AB-10300-DA	DAN562
98AB-10300-DB	DAN562
98AB-10300-DC	DAN562
98AB-10300-DD	DAN562
98AB-10300-DE	DAN562
98AB-10300-DF	DAN562
98AB-10300-DG	DAN562
98AB-10300-DH	DAN562
98AB-10300-DJ	DAN562
98AB-10300-GA	DAN588
98AB-10300-GB	DAN588
98AB-10300-GC	DAN588
98AB-10300-GD	DAN588
98AB-10300-GE	DAN588
98AB-10300-GF	DAN588
98AB-10300-GG	DAN588
98AB-10300-GH	DAN588
98AB-10300-GJ	DAN588
98AB-10300-GK	DAN588
98AB-10300-GL	DAN588
98AB-10300-GM	DAN588
98AB-10300-JA	DAN1124
98AB-10300-JB	DAN1124
98AB-10300-JC	DAN1124
98AB-10300-JD	DAN1124
98AB-10300-JE	DAN1124
98AB-10300-JF	DAN1124
98AB-10300-JG	DAN1124
98AB-11000-BA	DSN3001
98AB-11000-BB	DSN3001
98AB-11000-BC	DSN3001
98AB-11000-BD	DSN3001
98AB-11000-CA	DSN3001
98AB-11000-CB	DSN3001
98AB-11000-CC	DSN3001
98AB-11000-CD	DSN3001
9S51-10346-AA	DAN998
9S51-10346-AB	DAN998
9S51-10346-BA	DAN519
9S51-10346-BB	DAN519

FORD	DENSO
9S51-10346-CB	DAN1003
9S51-10346-DB	DAN1002
9S51-10346-EA	DAN1001
9S51-10346-FA	DAN997
9S51-10346-GA	DAN1004
9S51-10346-HA	DAN599
AC1T 11000 AA	DSN3012
BS51-10346-AA	DAN1005
BS51-10346-BA	DAN999
CC1T 11000 AA	DSN3012
CC1T 11000 AB	DSN3012
CV6T-10300-BC	DAN1073
CV6T-10300-DB	DAN1074
CV6T-10300-DC	DAN1074
CV6T-10300-FA	DAN1312
CV6T-10300-GA	DAN1313
R1M5T-10300-BD	DAN1124
R91AX-11000-KB1	DSN3003
R91FF-10300-JA	DAN504
R95FB-11000-BD	DSN3003
R95FF-10300-AA	DAN504
R95FF-10300-AC	DAN504
R97AB-10300-AD	DAN047
R97AB-10300-AE	DAN047
R97AB-10300-AE1	DAN047
R97KB-11000-AC1	DSN3003
R98AB-10300-DB	DAN562
R98AB-10300-GG	DAN588
R98AB-10300-GG1	DAN588
R98AB-10300-JC	DAN1124
RE2S6U-11000-DC	DSN3002
RE3M5T-10300-JD	DAN1059
RE3M5T-10300-LD	DAN1023
RE3M5T-10300-VD	DAN1016
RE3M5T-10300-YD	DAN930
RE3N11-10300-AF	DAN588
RE4M5T-10300-LD	DAN582
RE4M5T-10300-UD	DAN932
RM3M5T-10300-PD	DAN1119
YS4D-10300-AA	DAN588
YS4D-10300-AB	DAN588
YS4D-10300-AC	DAN588
YS4D-10300-AD	DAN588
YS4D-10300-AE	DAN588
YS4D-10300-AF	DAN588
YS4D-10300-AG	DAN588
YS4D-10300-AH	DAN588
YS4D-10300-AJ	DAN588
YS4U-11000-AB	DSN3001
YS4U-11000-AD	DSN3001
YS4U-11000-BA	DSN3001
YS4U-11000-BB	DSN3001

HITACHI	DENSO
LR1100-724	DAN1030
LR1100-724B	DAN1030
LR1100-724C	DAN1030
LR180-762	DAN1031
LR180-762B	DAN1031
LR180-762C	DAN1031
LR180-768	DAN1031
S114-753	DSN1488
S114-753A	DSN1488
S114-753B	DSN1488
S114-753C	DSN1488
S114-800C	DSN951
S114-818A	DSN952
S114-844	DSN954
S114-844A	DSN954
S114-875	DSN957
S114-902	DSN955
S114-902A	DSN955
S114-902B	DSN955
S114-902C	DSN955
S114-922	DSN955
S13-106A	DSN953
S13-106B	DSN953
S13-250	DSN958
S13-327	DSN953
S13-327A	DSN953
S13-551C	DSN956

HONDA	DENSO
31100-R1P-H01	DAN1370
31100-R40-A01	DAN1376
31100-RAA-A01	DAN1375
31100-RAA-A02	DAN1375
31100-RAA-A03	DAN1375
31100-RAA-A04	DAN1375
31100-RAA-A05	DAN1375
31100-RAA-AA0	DAN1375
31100-RBD-E01	DAN985
31100-RBD-E02	DAN985
31100-RSR-E01	DAN985
31100-RSX-G01	DAN1326
31100-RTA-003	DAN1375
31100-RTA-013	DAN1375
31100-RTA-023	DAN1375
31100-RTA-033	DAN1375
31100-RZ0-G01	DAN1326
31100-RZP-G01	DAN1148
31200-P5T-505	DSN604
31200-P5T-G00	DSN604
31200-PNE-G01	DSN1389
31200-PRB-A01	DSN1408
31200-PRB-A11	DSN1408
31200-PWA-G52	DSN1398
31200-RAD-003	DSN1406
31200-RB1-003	DSN1385
31200-RB1-013	DSN1385
31200-RBA-003	DSN1406
31200-RL0-G01	DSN1387
31200-RL0-G51	DSN1386
31200-RL0-G52	DSN1386
31200-RNA-003	DSN1391
31200-RNA-A01	DSN1391
31200-RNA-A11	DSN1391
31200-RNA-J01	DSN1391
31200-RSH-E01	DSN1398
31200-RZP-E01	DSN1390
31200-RZP-G01	DSN1390
CSC29	DAN1375
CSC91	DAN985
CSD73	DAN1375
CSD86	DAN985
CSF37	DAN1148
CSF89	DAN1376
CSJ54	DAN1370
CSK04	DAN1326
CSK28	DAN1326
DS4R5	DSN1391
DS4R7	DSN1390
DS4RC	DSN1391
DS4RD	DSN1391
DSH6	DSN1389
DSHD9	DSN1408
DSDHG	DSN1406
DSDHL	DSN1408
DSKE7	DSN1406
DSKEG	DSN1391
DSKEQ	DSN1390
DSKET	DSN1391
DSKEV	DSN1391
DSKEW	DSN1385
DU4V6	DSN1387
DV4DA	DSN1398
DV4DJ	DSN1398
DY4J5	DSN1386

HYUNDAI	DENSO
37300-2F200	DAN1102

ISUZU	DENSO
8-94364722-0	DSN1488
8-94364722-1	DSN1488
8-94384314-0	DSN1488
8-94384314-1	DSN1488
8-97064553-0	DSN1488
8-97210373-0	DAN1488
8-97369-716-0	DAN1487
8-97369-716-1	DAN1487
8-98153-004-0	DAN1487
8-98196-585-0	DAN1487
8-98229-071-0	DAN1487

ISUZU	DENSO
8-98290-323-0	DAN1487

IVECO	DENSO
551959670	DSN3014
5801440013	DSN3013

JAGUAR	DENSO
1X43-10300-BC	DAN1407
1X43-10300-BD	DAN1407
2R83-10300-AA	DAN1408
2R83-10300-AB	DAN1408
4R83-11001-AC	DSN1300
4R83-11001-AD	DSN1300
8W83-10300-AB	DAN1103
8W83-10300-AC	DAN1103
8W83-10300-AD	DAN1103
8W83-10300-AE	DAN1103
8W83-11001-BB	DSN1383
8W83-11001-BC	DSN1383
8W83-11001-BD	DSN1383
8X23-10300-BA	DAN1201
8X23-10300-BB	DAN1201
8X23-11001-AA	DSN1300
8X23-11001-AB	DSN1300
8X23-11001-AC	DSN1300
8X23-11001-AD	DSN1300
96JV-11001-AB	DSN605
96JV-11001-AC	DSN605
AJ83990	DSN605
BJ32-10300-AC	DAN1111
BJ32-10300-AD	DAN1111
C2C15283	DSN1300
C2C32959	DSN1300
C2D16464	DAN1103
C2D19968	DSN1412
C2D20468	DAN1202
C2D22746	DAN1103
C2D27864	DSN1383
C2D27865	DSN1300
C2D3536	DSN1383
C2D36864	DSN1410
C2D42135	DAN1103
C2D47590	DAN1202
C2D48932	DAN1103
C2D51168	DSN1300
C2D59622	DAN1103
C2P26075	DSN1383
C2S3710	DAN1407
C2217063	DAN1111
C2219766	DAN1203
C2231658	DAN1111
C2231669	DAN1203
C223414	DAN1201
C223414E	DAN1201
C226560	DSN1300
CW93-10300-AB	DAN1202
CW93-10300-AC	DAN1202
CW93-10300-AD	DAN1202
CX23-10300-AB	DAN1203
CX23-10300-AC	DAN1203
CX23-10300-AD	DAN1203
DBC12258	DAN671
DX23-11001-BC	DSN1412
DX23-11001-BD	DSN1412
FK72-11001-AB	DSN1411
FK72-11001-AC	DSN1411
FW93-11001-AB	DSN1410
FW93-11001-AC	DSN1410
GX73-11001-AC	DSN1425
GX73-11001-AD	DSN1425
GX73-11001-BC	DSN1424
GX73-11001-BD	DSN1424
GX73-11001-DB	DSN1411
GX73-11001-DC	DSN1411
GX73-11001-EB	DSN1410
GX73-11001-EC	DSN1410
HK83-10300-AA	DAN1103
HK83-10300-AB	DAN1103
LCA1850AB	DSN605
LCA1850CA	DSN605
LJA1800AC	DAN672

Starters & Alternators

Cross Reference Chart

JAGUAR	DENSO
LJA1800AD	DAN672
LJA1800AE	DAN672
LNA1800AA	DAN671
LNC1800AA	DAN672
LNC1800AA321	DAN672
T2H15686	DAN1103
T2H19157	DSN1411
T2H1941	DSN1425
T2H2229	DSN1424
T2H2799	DSN1411
T2H3243	DSN1411
T2H3246	DSN1410
XR817076	DAN1408
XR837164	DAN1408

JEEP	DENSO
51874105	DAN1078
51884351	DAN1121
51929089	DAN1146

KIA	DENSO
37300-2F200	DAN1102

LANCIA	DENSO
46430524	DAN630
46430528	DAN1037
46448433	DAN1037
46448434	DAN1037
46454211	DSN579
46542889	DAN517
46544329	DAN501
46554404	DAN519
46559015	DAN630
46748353	DAN502
46765838	DAN501
46782213	DAN501
46809068	DAN502
46823546	DAN1003
46823547	DAN1002
46835095	DAN997
46843091	DAN517
51700675	DAN998
51709131	DAN519
51709133	DAN517
51714791	DAN519
51714794	DAN517
51718499	DAN1002
51727333	DAN1005
51764265	DAN994
51784844	DAN1002
51784845	DAN1002
51784847	DAN1003
51787196	DAN999
51788658	DAN993
51793678	DAN995
51805799	DAN1002
51805800	DAN1002
51805801	DAN997
51805803	DAN1003
51820623	DAN1147
51820624	DAN1084
51829380	DSN975
51854898	DAN1000
51854901	DAN994
51854902	DAN995
51854903	DAN993
51854905	DAN1003
51854909	DAN1002
51854910	DAN1002
51854911	DAN997
51854912	DAN997
51859037	DAN517
51859038	DAN519
51859041	DAN999
51859042	DAN998
51859044	DAN1005
51859058	DAN1365
51872564	DSN975
51874105	DAN1078
51880173	DAN1086
51929094	DAN1078

LANCIA	DENSO
51929095	DAN1078
52003508	DAN1000
71723039	DAN1002
71773262	DAN502
71794523	DAN1002
73501591	DAN1062
7634289	DAN615
7646189	DAN615
7697863	DAN615
9638275480	DAN1336

LAND ROVER	DENSO
5H22-10300-CC	DAN991
5H22-11002-AC	DSN944
5H22-11002-AD	DSN944
6G9N-11000-MA	DSN1208
6G9N-11000-MB	DSN1208
6G9N-11000-NA	DSN1209
6G9N-11000-NB	DSN1209
7H12-11002-AA	DSN3012
7H12-11002-AB	DSN3012
7H42-10300-AC	DAN989
7H42-11001-AB	DSN1207
7H42-11001-AC	DSN1207
8W83-10300-AB	DAN1103
8W83-10300-AD	DAN1103
8W83-10300-AE	DAN1103
8W83-10300-BA	DAN1103
8W83-10300-BB	DAN1103
AH22-10300-AB	DAN1105
AH22-10300-AC	DAN1105
AH22-10300-AD	DAN1105
AH22-10300-BA	DAN1106
AH22-10300-BB	DAN1106
AH22-11001-AC	DSN976
AH22-11001-AD	DSN976
AH22-11001-AE	DSN976
AH22-11001-AF	DSN976
AH22-11001-AG	DSN976
AH42-11001-BB	DSN1364
AH52-11001-AC	DSN1208
AMR3412	DAN005
AMR3412E	DAN005
AMR4249	DAN005
AMR4249E	DAN005
BH42-10300-AC	DAN1110
BJ32-10300-AC	DAN1111
BJ32-10300-AD	DAN1111
BJ32-11001-AC	DSN1384
BJ32-11001-AD	DSN1384
BJ32-11001-AE	DSN1384
BJ32-11001-AF	DSN1384
CH12-10300-BC	DAN1104
CPLA-10300-AB	DAN1112
CPLA-10300-AC	DAN1112
CPLA-11001-AC	DSN1420
CPLA-11001-BD	DSN1418
CPLA-11001-BE	DSN1418
CPLA-11001-BF	DSN1418
CPLA-11001-CB	DSN1419
DPLA-11001-AC	DSN1415
DPLA-11001-AD	DSN1415
EJ32-11001-AB	DSN1365
EJ32-11001-AC	DSN1365
EJ32-11001-AD	DSN1365
ERR6999	DAN670
ERR6999E	DAN670
FK72-11001-AB	DSN1411
FK72-11001-AC	DSN1411
FPLA-11001-AA	DSN1416
FPLA-11001-AB	DSN1416
FPLA-11001-BA	DSN1417
FPLA-11001-BB	DSN1417
GJ32-11001-AC	DSN1423
GJ32-11001-AD	DSN1423
GJ32-11001-AE	DSN1423
GJ32-11001-BC	DSN1422
GJ32-11001-BD	DSN1422
GJ32-11001-BE	DSN1422
GPLA-11001-CB	DSN1421

LAND ROVER	DENSO
GX73-11001-DB	DSN1411
GX73-11001-DC	DSN1411
HK83-10300-AA	DAN1103
HK83-10300-AB	DAN1103
LR003468	DSN1208
LR003469	DSN1209
LR006190	DAN670
LR007023	DSN1208
LR007024	DSN1209
LR007134	DAN673
LR007372	DSN1208
LR007373	DSN1209
LR008860	DAN991
LR008861	DAN987
LR008862	DAN986
LR009432	DSN1208
LR009433	DSN1209
LR010512	DSN1207
LR010513	DAN989
LR010514	DAN990
LR010547	DSN3012
LR011231	DAN1103
LR011262	DSN1364
LR013540	DSN976
LR013843	DAN1106
LR013847	DAN1105
LR014060	DSN1208
LR016450	DSN1364
LR021461	DSN1207
LR022528	DAN1110
LR023405	DAN1103
LR023421	DAN1103
LR025840	DSN3012
LR026344	DAN989
LR027517	DAN989
LR028116	DAN1111
LR028120	DSN1384
LR029152	DSN1207
LR029981	DAN1104
LR031026	DAN1111
LR032541	DSN1207
LR034013	DAN1112
LR034020	DSN1420
LR034027	DSN1418
LR034028	DSN1419
LR039482	DSN944
LR041976	DSN1415
LR043924	DSN976
LR043962	DSN944
LR044091	DSN1384
LR047573	DSN1365
LR052752	DSN976
LR054994	DAN1112
LR055316	DAN1110
LR056981	DSN976
LR059796	DSN1411
LR061893	DSN1416
LR061894	DSN1417
LR065246	DAN1103
LR065818	DSN1384
LR065819	DSN1365
LR065865	DAN1103
LR065866	DAN1105
LR066996	DSN976
LR070399	DSN1421
LR070686	DSN1423
LR070687	DSN1422
LR070690	DSN1411
LR070953	DAN1106
LR072756	DAN1105
LR072764	DAN1112
LR073680	DAN1106
LR077418	DAN1103
LR078806	DAN987
LR079918	DSN1416
LR080292	DSN1417
LR080299	DSN976
LR080305	DSN1418
LR080307	DSN1415
LR080315	DSN1411
LR084458	DSN1384

LAND ROVER	DENSO
LR084460	DSN1422
LR084922	DSN1365
LR085507	DSN1423
LR086809	DSN1411
LR087021	DSN944
LR091107	DAN1103
LR124471	DAN1103
NAD100580	DSN604
NAD100580E	DSN604
NAD100952	DSN603
NAD100952L	DSN603
NAD101090	DSN602
NAD101140	DSN601
NAD101240	DSN600
NAD101240E	DSN600
NAD101420	DSN602
NAD101500	DSN601
NAD101500E	DSN601
NAD500080	DSN944
NAD500080E	DSN944
NAD500270	DSN3012
NAD500280	DSN1207
NAD500330	DSN944
YLE101820	DAN674
YLE101890	DAN673
YLE102060	DAN674
YLE102060E	DAN674
YLE500190	DAN991
YLE500190E	DAN991
YLE500200	DAN987
YLE500200E	DAN987
YLE500240	DAN986
YLE500240E	DAN986
YLE500250	DAN988
YLE500290	DAN990
YLE500340	DAN989
YLE500390	DAN991
YLE500400	DAN987
YLE500410	DAN986
YLE500420	DAN988
YLE500430	DAN990
YLE500440	DAN989

LEXUS	DENSO
27060-26030	DAN1013
27060-31050	DAN1354
27060-31051	DAN1354
27060-31052	DAN1354
27060-31060	DAN1483
27060-31061	DAN1483
27060-31062	DAN1483
27060-31201	DAN1354
27060-31210	DAN1483
27060-31211	DAN1483
27060-31212	DAN1483
27060-38040	DAN1281
27060-38041	DAN1281
27060-38050	DAN1208
27060-38070	DAN1281
27060-38090	DAN1205
27060-38110	DAN1205
27060-50340	DAN1279
28100-03100	DSN929
28100-0G040	DSN984
28100-0R010	DSN984
28100-31070	DSN1256
28100-31071	DSN1256
28100-38020	DSN1222
28100-38021	DSN1222
28100-38030	DSN1222
28100-38031	DSN1222
28100-38050	DSN1236
28100-38070	DSN1236
28100-50080	DSN1223
28100-50081	DSN1223
28100-50110	DSN1223
28100-74260	DSN929

MASERATI	DENSO
000180169	DSN1457
180169	DSN1457

Starters & Alternators

Cross Reference Chart

MAZDA	DENSO
1E03-18-400A	DSN3003
1E07-18-300	DAN047
C601-18-400	DSN3001
C601-18-400A	DSN3001
Y601-18-300	DAN930
Y601-18-300B	DAN930

MERCEDES-BENZ	DENSO
000 906 01 26	DSN967
000 906 01 26 80	DSN967
005 151 39 01	DSN3010
005 151 39 01 80	DSN3010
005 151 40 01	DSN3010
006 151 25 01	DSN968
006 151 25 01 80	DSN968
006 151 45 01	DSN967
006 151 45 01 80	DSN967
006 151 46 01	DSN968
006 151 46 01 80	DSN968
006 151 74 01	DSN968
006 151 74 01 80	DSN968
270 906 00 26	DSN1206
270 906 00 26 80	DSN1206
270 906 07 00	DSN1206
270 906 07 00 80	DSN1206
274 906 04 00	DSN1205
274 906 04 00 80	DSN1205
274 906 05 00	DSN1205
274 906 16 00	DSN1205
274 906 16 00 80	DSN1205
274 906 17 00	DSN1205
274 906 21 00	DSN1205
274 906 21 00 80	DSN1205
645 906 03 00	DSN1206
645 906 03 00 80	DSN1206
645 906 08 00	DSN1206
645 906 08 00 80	DSN1206
651 906 00 26	DSN967
651 906 00 26 80	DSN967
651 906 45 00	DSN1445
651 906 45 00 80	DSN1445
A 000 906 01 26	DSN967
A 000 906 01 26 80	DSN967
A 003 151 50 01	DSN3011
A 004 151 45 01	DSN3011
A 004 151 65 01	DSN3011
A 004 151 70 01	DSN3011
A 004 151 89 01	DSN3011
A 004 151 92 01	DSN3011
A 004 151 97 01	DSN3011
A 005 151 13 01	DSN3011
A 005 151 39 01	DSN3010
A 005 151 39 01 80	DSN3010
A 005 151 40 01	DSN3010
A 005 151 66 01	DSN3011
A 006 151 25 01	DSN968
A 006 151 25 01 80	DSN968
A 006 151 45 01	DSN967
A 006 151 45 01 80	DSN967
A 006 151 46 01	DSN968
A 006 151 46 01 80	DSN968
A 006 151 74 01	DSN968
A 270 906 00 26	DSN1206
A 270 906 00 26 80	DSN1206
A 270 906 07 00	DSN1206
A 270 906 07 00 80	DSN1206
A 274 906 04 00	DSN1205
A 274 906 04 00 80	DSN1205
A 274 906 05 00	DSN1205
A 274 906 16 00	DSN1205
A 274 906 16 00 80	DSN1205
A 274 906 17 00	DSN1205
A 274 906 21 00	DSN1205
A 274 906 21 00 80	DSN1205
A 645 906 03 00	DSN1206
A 645 906 03 00 80	DSN1206
A 645 906 08 00	DSN1206
A 645 906 08 00 80	DSN1206
A 651 906 00 26	DSN967
A 651 906 00 26 80	DSN967

MERCEDES-BENZ	DENSO
A 651 906 45 00	DSN1445
A 651 906 45 00 80	DSN1445
A 004 151 63 01	DSN3011
A 004 151 67 01	DSN3011
A 004 151 71 01	DSN3011

MG	DENSO
GNUJ4821	DSN603
GNUJ4824	DSN601
GNUJ4825	DSN941
GNUJ4904	DSN601
NAD100952	DSN603
NAD100952L	DSN603
NAD101140	DSN601
NAD101180	DSN941
NAD101180E	DSN941
NAD101500	DSN601
NAD101500E	DSN601
NAD180101	DSN941

MINI	DENSO
12317640132	DAN1464
12317640875	DAN1464
12317790879	DAN981
12317791334	DAN981
7640132	DAN1464
7640875	DAN1464
7790879	DAN981
7791334	DAN981

MITSUBISHI	DENSO
A002T14592	DAN504
A002TA2292	DAN504
A005TA6291	DAN1336
A005TA6291ZE	DAN1336
A005TA6291ZEB	DAN1336
A005TA6291ZEC	DAN1336
A005TA6291ZED	DAN1336
A005TA6292	DAN515
A005TA6292C	DAN515
A005TA6292F	DAN515
A005TA6292G	DAN515
A005TA6292ZE	DAN515
A005TA6292ZEB	DAN515
A005TA6391	DAN1336
A005TA6391A	DAN1336
A005TA6391B	DAN1336
A005TA6391C	DAN1336
A005TA6392	DAN515
A005TA6392C	DAN515
A2T14592	DAN504
A2TA2292	DAN504
A2TB3191	DAN1031
M000T85381	DSN3004
M000T86081	DSN3004
M001T80381	DSN3004

NISSAN	DENSO
23100-4M510	DAN1031
23100-AU000	DAN1031
23100-BN00A	DAN1030
23100-BN300	DAN1030
23100-BN305	DAN1030
23100-BU00A	DAN1031
23100-BU010	DAN1031
23100-BU015	DAN1031
23300-0M301	DSN951
23300-0M302	DSN951
23300-0M30A	DSN951
23300-10T01	DSN953
23300-17C60	DSN951
23300-18C60	DSN951
23300-2T700	DSN953
23300-3T700	DSN953
23300-4J600	DSN952
23300-50Y01	DSN951
23300-5J201	DSN952
23300-6T000	DSN953
23300-6T001	DSN953
23300-6T00A	DSN953
23300-7F400	DSN953

NISSAN	DENSO
23300-80G00	DSN953
23300-80G01	DSN953
23300-81N00	DSN951
23300-81N01	DSN951
23300-8H300	DSN954
23300-8H30A	DSN954
23300-CK800	DSN955
23300-CK80B	DSN955
23300-EN200	DSN955
23300-EN20A	DSN955
23300-EN20B	DSN955
23300-EN20D	DSN955
23300-VC101	DSN956
23300-VC10B	DSN956

OPEL	DENSO
10479273	DAN1342
10479384	DAN1342
10479923	DAN1342
10479947	DAN1342
10480225	DAN1341
10480384	DAN1342
10480409	DAN1342
12 02 046	DSN1488
12 02 101	DSN1488
12 02 153	DSN1488
12 02 229	DSN1008
12 02 302	DAN1331
12 02 303	DAN1331
12 02 373	DAN1322
12 02 374	DAN1334
12 02 386	DAN1331
12 02 441	DAN1331
12 02 462	DAN1331
12 02 472	DAN1322
12 02 473	DAN1334
12 02 477	DAN1331
12 02 504	DSN1008
1202148	DSN3017
1202382	DSN1453
1202531	DSN1453
1204101	DAN1488
1204108	DAN1342
1204123	DAN1341
1204126	DAN1343
1204129	DAN1343
1204145	DAN1342
1204154	DAN1342
1204426	DAN583
1204429	DAN1033
1204432	DAN1032
1204433	DAN510
1204434	DAN509
1204436	DAN506
12759595	DAN1009
13117278	DAN1032
13117279	DAN1033
13117340	DAN510
13117341	DAN506
13153236	DAN509
13153237	DAN1034
13156051	DAN1341
13197578	DAN1033
13222929	DAN1055
13222930	DAN1340
13222934	DAN583
13222935	DAN584
13222936	DAN585
13243463	DAN1033
13256928	DAN1034
13256929	DAN1033
13256930	DAN1032
13256931	DAN585
13256932	DAN584
13256933	DAN583
13283343	DAN1032
13283344	DAN1033
13512744	DAN1331
13512745	DAN1331
13585664	DAN1322
13585666	DAN1334

OPEL	DENSO
13585666B	DAN1334
13586365	DAN1331
13586366	DAN1331
13587304	DAN1331
24422273	DSN3017
24439410	DAN1342
24454431	DSN3017
24463063	DAN1341
3493823	DAN1342
3493824	DAN1342
3493847	DAN1342
3493848	DAN1342
55351630	DSN3017
55556070	DAN1341
55556071	DAN1341
55572439	DSN1008
55579119	DSN1453
62 02 058	DSN1488
6202009	DSN3017
6202014	DSN3017
6202016	DSN3009
6202039	DSN3017
6202060	DSN3017
6202077	DSN3009
6204000	DAN1342
6204002	DAN1342
6204003	DAN1342
6204008	DAN1342
6204073	DAN1341
6204076	DAN1341
6204088	DAN1343
6204098	DAN1341
6204109	DAN1342
6204125	DAN1343
6204133	DAN1342
6204138	DAN1341
6204151	DAN1342
6204155	DAN1341
6204166	DAN1488
6204180	DAN1032
6204181	DAN1033
6204187	DAN510
6204188	DAN506
6204189	DAN509
6204192	DAN1341
6204196	DAN1342
6204201	DAN1034
6204204	DAN1341
6204206	DAN1341
6204209	DAN1341
6204212	DAN1032
6204213	DAN1033
6204214	DAN1341
6204215	DAN1341
6204230	DAN1341
6204234	DAN1341
6204256	DAN1055
6204257	DAN583
6204258	DAN584
6204259	DAN585
6204261	DAN1033
6204265	DAN1340
6204273	DAN1034
6204280	DAN1034
6204281	DAN1033
6204282	DAN585
6204283	DAN584
6204290	DAN1032
6204291	DAN1033
6204293	DAN510
6204294	DAN506
6204664	DAN1032
90289247	DAN1343
90356897	DAN1342
90389246	DAN1343
90389247	DAN1343
90413760	DAN1342
90443760	DAN1342
90443929	DAN1342
90443930	DAN1342

Starters & Alternators

Cross Reference Chart

OPEL	DENSO
90511445	DAN1343
90511446	DAN1343
90512467	DSN3017
90519331	DSN3017
90561970	DAN1341
90561971	DAN1341
9115197	DSN3009
9117851	DAN1341
9117931	DAN1341
9120557	DSN1488
9133600	DAN1341
9163937	DAN1342
9192823	DAN1341
9194167	DAN1343
9195753	DAN1341
9200962	DSN3017
9201489	DAN1342
92059984	DAN1342
93169024	DAN1033
93169026	DAN1032
93169028	DAN510
93169030	DAN509
93169032	DAN506
93169257	DAN510
93169258	DAN506
93169259	DAN509
93169260	DAN1009
93171526	DSN3017
93171936	DSN3009
93174017	DSN3017
93174029	DSN3017
93175779	DAN1343
93175788	DAN1342
93175795	DAN1341
93175796	DAN1341
93175815	DAN1342
93175830	DAN1488
93175893	DSN1488
93175963	DAN1342
93176034	DSN3017
93180098	DAN510
93180102	DAN506
93180104	DAN509
93180415	DAN1341
93181383	DAN1342
93183381	DAN1034
93183436	DAN1341
93183891	DAN1341
93184064	DAN1341
93184533	DSN3009
93185260	DAN1032
93185261	DAN1033
93186485	DAN1341
93189241	DAN1341
93189243	DAN1341
93189246	DAN1341
93190138	DAN1340
93190915	DAN1034
93603136	DAN1343
94384314	DSN1488
9512655	DSN3017
95519877	DAN1331
95519897	DAN1331
95519907	DAN1322
95519908	DAN1334
95519912	DAN1331
95520337	DSN1008
95520368	DSN1453
95524437	DAN1331
95524826	DAN1331
95524960	DAN1331
9562207	DAN510
9562208	DAN509
9562209	DAN506
97064553	DSN1488
97210373	DAN1488

PEUGEOT	DENSO
16 080 646 80	DSN1368
1608066080	DAN1071
1608858080	DAN997

PEUGEOT	DENSO
1608858180	DAN1086
1610048280	DAN1071
1610815380	DAN1325
1611206880	DSN3013
1614379980	DSN3013
1617116680	DAN997
5702A4	DAN515
5702AQ	DAN515
5702C8	DAN515
5702C9	DAN515
5702E8	DAN1336
5702J1	DAN1035
5702J2	DAN1036
5702K1	DAN1336
5702K2	DAN1336
5702L0	DAN1035
5702L1	DAN1036
57055A	DAN1336
57055B	DAN1336
57055P	DAN1063
57055Q	DAN1063
57055T	DAN1336
57056C	DAN515
57056E	DAN515
57056M	DAN1063
57056U	DAN1063
57057G	DAN1063
57057H	DAN1063
5705AP	DAN515
5705AW	DAN515
5705AZ	DAN1336
5705EL	DAN1063
5705EN	DAN515
5705EP	DAN515
5705FA	DAN515
5705FC	DAN1336
5705GF	DAN1063
5705GG	DAN1063
5705GJ	DAN1063
5705GK	DAN1063
5705GN	DAN1336
5705GP	DAN1336
5705GQ	DAN1336
5705GZ	DAN515
5705KH	DAN1035
5705KJ	DAN1036
5705KX	DAN1336
5705KY	DAN1336
5705KZ	DAN515
5705NN	DAN1035
5705NP	DAN1036
5705NY	DAN1001
5802AH	DSN942
5802AP	DSN942
5802AQ	DSN3014
5802AS	DSN3012
5802AX	DSN942
5802AY	DSN3013
5802CY	DSN3004
5802EE	DSN3013
5802FA	DSN3014
5802FC	DSN3012
5802FE	DSN942
5802FF	DSN942
5802FQ	DSN3013
5802V8	DSN3004
5802W5	DSN3004
5802W8	DSN3004
5802Z0	DSN3013
675092580	DSN3012
96 715 308 80	DSN1368
96 884 773 80	DSN1368
9633782580	DAN1336
9635557580	DAN1063
9635557780	DAN1063
9636204480	DAN1336
9637856880	DAN1063
9638275580	DAN1336
9638275780	DAN1336
9638275880	DAN1336
9638275980	DAN1336

PEUGEOT	DENSO
9638276180	DAN1063
9638276280	DAN1063
9638525380	DSN942
9638543680	DAN515
9638543780	DAN515
9638544180	DAN515
9638544280	DAN515
9638544480	DAN515
9641398480	DAN1336
9641398680	DAN1336
9641727480	DAN1063
9642879480	DAN515
9642879680	DAN515
9642879780	DAN515
9642879980	DAN1336
9642880080	DAN1336
9642880180	DAN1336
9648111680	DSN3004
9649448380	DSN942
9649611480	DAN1336
9649611580	DAN1336
9649611680	DAN515
9649611780	DAN515
9649611880	DAN515
9656299480	DSN3004
9656956080	DAN1336
9656956280	DAN515
9656956380	DAN1336
9664883080	DSN942
9664883081	DSN942
9665577480	DAN515
9665577580	DAN1336
9665577780	DAN1336
9675092580	DSN3012
9678178280	DAN1325
9688237380	DAN1071
9806007480	DAN1071

PORSCHE	DENSO
958 604 109 00	DSN965
958 604 109 X	DSN965
9A1 604 103 00	DSN970
9A1 604 103 X	DSN970
9A1 604 104 00	DSN971
9A1 604 104 X	DSN971

RENAULT	DENSO
1761052700	DSN955
7701065384	DSN955
8201268221	DSN955

ROLLS-ROYCE	DENSO
12417566337	DSN1476
12417579152	DSN1476
7566337	DSN1476
7579152	DSN1476

ROVER	DENSO
GNU4821	DSN603
GNU4824	DSN601
GNU4825	DSN941
GNU4904	DSN601
NAD100952	DSN603
NAD100952L	DSN603
NAD101140	DSN601
NAD101180	DSN941
NAD101180E	DSN941
NAD101500	DSN601
NAD101500E	DSN601
NAD180101	DSN941

SAAB	DENSO
12759595	DAN1009
13153236	DAN509
5342340	DSN3017
5343371	DSN3017
55351630	DSN3017
93169260	DAN1009
93180104	DAN509
93184533	DSN3009
93184916	DSN3017

SAAB	DENSO
93184917	DSN3017
93184922	DSN3017
93184923	DSN3017
9544537	DSN3017

SEAT	DENSO
02B 911 023 D	DSN3016
02B 911 023 J	DSN3016
02B 911 023 L	DSN3016
02B 911 023 N	DSN3016
02E 911 022 C	DAN1460
02E 911 022 CX	DSN1460
02E 911 023 H	DSN3008
02E 911 023 HX	DSN3008
02E 911 023 Q	DAN1460
02E 911 023 OX	DSN1460
02E 911 023 T	DSN1460
02E 911 023 TX	DSN1460
02E 911 024 B	DSN1464
02E 911 024 BX	DSN1464
02E 911 024 C	DSN1460
02E 911 024 CX	DSN1460
02E 911 024 D	DSN1464
02E 911 024 DX	DSN1464
02E 911 024 J	DSN1460
02E 911 024 JX	DSN1460
02E 911 024 M	DSN1464
02E 911 024 MX	DSN1464
02M 911 021 B	DSN3005
02M 911 021 BX	DSN3005
02M 911 021 G	DSN1468
02M 911 021 GX	DSN1468
02M 911 021 P	DSN1461
02M 911 021 PX	DSN1461
02M 911 023 G	DSN3005
02M 911 023 GX	DSN3005
02M 911 023 M	DSN3005
02M 911 023 MX	DSN3005
02M 911 024 B	DSN1461
02M 911 024 BX	DSN1461
02M 911 024 C	DSN1461
02M 911 024 CX	DSN1461
02M 911 024 G	DSN1461
02M 911 024 GX	DSN1461
02M 911 024 H	DSN962
02M 911 024 HX	DSN962
02M 911 024 J	DSN1468
02M 911 024 JX	DSN1468
02M 911 024 Q	DSN1468
02M 911 024 QX	DSN1468
02M 911 024 S	DSN1461
02M 911 024 SX	DSN1461
02T 911 023 R	DSN3006
02T 911 023 RX	DSN3006
02T 911 023 S	DSN3006
02T 911 024 A	DSN3006
02T 911 024 B	DSN3006
02T 911 024 C	DSN3006
02T 911 024 K	DSN3006
02T 911 024 N	DSN3006
02Z 911 021 K	DSN1462
02Z 911 021 KX	DSN1462
02Z 911 023 F	DSN3007
02Z 911 023 FX	DSN3007
02Z 911 023 H	DSN3007
02Z 911 023 HX	DSN3007
02Z 911 023 M	DSN963
02Z 911 023 MX	DSN963
02Z 911 023 N	DSN963
02Z 911 023 NX	DSN963
02Z 911 023 P	DSN963
02Z 911 023 PX	DSN963
02Z 911 024	DSN1466
02Z 911 024 A	DSN1462
02Z 911 024 AX	DSN1462
02Z 911 024 B	DSN1462
02Z 911 024 BX	DSN1462
02Z 911 024 H	DSN1462
02Z 911 024 J	DSN3007
02Z 911 024 JX	DSN3007

Starters & Alternators

Cross Reference Chart

SEAT	DENSO
02Z 911 024 K	DSN963
02Z 911 024 KX	DSN963
02Z 911 024 L	DSN1462
02Z 911 024 LX	DSN1462
02Z 911 024 X	DSN1466
03L 903 023	DAN1328
03L 903 023 A	DAN1328
03L 903 023 AX	DAN1328
03L 903 023 X	DAN1328
03L 903 024 M	DAN1328
03L 903 024 MX	DAN1328
068 911 023 P	DSN3015
068 911 023 R	DSN3015
068 911 023 S	DSN3015
068 911 024 B	DSN3015
068 911 024 C	DSN3015
068 911 024 E	DSN3015
068 911 024 F	DSN3015
068 911 024 G	DSN3015
09A 911 023	DSN957
09A 911 023 A	DSN958
09A 911 023 B	DSN958
09A 911 023 BX	DSN958
09A 911 023 X	DSN957
0AH 911 023 F	DSN1467
0AH 911 023 F	DSN964
0AH 911 023 FX	DSN1467
0AH 911 023 FX	DSN964
0AH 911 023 G	DSN1467
0AH 911 023 GX	DSN1467
0AM 911 021 E	DSN1463
0AM 911 021 EX	DSN1463
0AM 911 023 G	DSN1463
0AM 911 023 GX	DSN1463
0AM 911 023 H	DSN1463
0AM 911 023 HX	DSN1463
0AM 911 023 J	DSN1463
0AM 911 023 JX	DSN1463
0AM 911 023 M	DSN1463
0AM 911 023 MX	DSN1463
0AM 911 023 N	DSN1465
0AM 911 023 NX	DSN1465
0AM 911 023 R	DSN1465
0AM 911 023 RX	DSN1465
0AM 911 024 A	DSN1465
0AM 911 024 AX	DSN1465

SKODA	DENSO
02B 911 023 D	DSN3016
02B 911 023 J	DSN3016
02B 911 023 L	DSN3016
02B 911 023 N	DSN3016
02E 911 022 C	DSN1460
02E 911 022 CX	DSN1460
02E 911 023 H	DSN3008
02E 911 023 HX	DSN3008
02E 911 023 T	DSN1460
02E 911 023 TX	DSN1460
02E 911 024 B	DSN1464
02E 911 024 BX	DSN1464
02E 911 024 C	DSN1460
02E 911 024 CX	DSN1460
02E 911 024 D	DSN1464
02E 911 024 DX	DSN1464
02E 911 024 H	DSN1460
02E 911 024 HX	DSN1460
02E 911 024 J	DSN1460
02E 911 024 JX	DSN1460
02E 911 024 M	DSN1464
02E 911 024 MX	DSN1464
02M 911 021 B	DSN3005
02M 911 021 BX	DSN3005
02M 911 021 E	DSN1461
02M 911 021 EX	DSN1461
02M 911 021 G	DSN1468
02M 911 021 GX	DSN1468
02M 911 021 P	DSN1461
02M 911 021 PX	DSN1461
02M 911 023 G	DSN3005
02M 911 023 GX	DSN3005
02M 911 023 M	DSN3005

SKODA	DENSO
02M 911 023 MX	DSN3005
02M 911 024 B	DSN1461
02M 911 024 BX	DSN1461
02M 911 024 C	DSN1461
02M 911 024 CX	DSN1461
02M 911 024 G	DSN1461
02M 911 024 GX	DSN1461
02M 911 024 J	DSN1468
02M 911 024 JX	DSN1468
02M 911 024 Q	DSN1468
02M 911 024 QX	DSN1468
02M 911 024 S	DSN1461
02M 911 024 SX	DSN1461
02T 911 023 R	DSN3006
02T 911 023 RX	DSN3006
02T 911 023 S	DSN3006
02T 911 024 A	DSN3006
02T 911 024 B	DSN3006
02T 911 024 C	DSN3006
02T 911 024 K	DSN3006
02T 911 024 N	DSN3006
02Z 911 021 C	DSN1462
02Z 911 021 CX	DSN1462
02Z 911 021 K	DSN1462
02Z 911 021 KX	DSN1462
02Z 911 023 F	DSN3007
02Z 911 023 FX	DSN3007
02Z 911 023 H	DSN3007
02Z 911 023 HX	DSN3007
02Z 911 023 M	DSN963
02Z 911 023 MX	DSN963
02Z 911 023 N	DSN963
02Z 911 023 NX	DSN963
02Z 911 023 P	DSN963
02Z 911 023 PX	DSN963
02Z 911 024	DSN1466
02Z 911 024 A	DSN1462
02Z 911 024 AX	DSN1462
02Z 911 024 B	DSN1462
02Z 911 024 BX	DSN1462
02Z 911 024 H	DSN1462
02Z 911 024 HX	DSN1462
02Z 911 024 J	DSN3007
02Z 911 024 JX	DSN3007
02Z 911 024 K	DSN963
02Z 911 024 KX	DSN963
02Z 911 024 L	DSN1462
02Z 911 024 LX	DSN1462
02Z 911 024 X	DSN1466
03L 903 023	DAN1328
03L 903 023 A	DAN1328
03L 903 023 AX	DAN1328
03L 903 023 X	DAN1328
03L 903 024 M	DAN1328
03L 903 024 MX	DAN1328
068 911 023 P	DSN3015
068 911 023 R	DSN3015
068 911 023 S	DSN3015
068 911 024 B	DSN3015
068 911 024 C	DSN3015
068 911 024 E	DSN3015
068 911 024 F	DSN3015
068 911 024 G	DSN3015
0AH 911 023 G	DSN1467
0AH 911 023 GX	DSN1467
0AM 911 021 B	DSN1463
0AM 911 021 BX	DSN1463
0AM 911 021 E	DSN1463
0AM 911 021 EX	DSN1463
0AM 911 023 G	DSN1463
0AM 911 023 J	DSN1463
0AM 911 023 JX	DSN1463
0AM 911 023 M	DSN1463
0AM 911 023 MX	DSN1463
0AM 911 023 N	DSN1465
0AM 911 023 NX	DSN1465
0AM 911 023 R	DSN1465
0AM 911 023 RX	DSN1465
0AM 911 024 A	DSN1465
0AM 911 024 AX	DSN1465

SUBARU	DENSO
23300AA700	DSN1487
23300AA701	DSN1487

SUZUKI	DENSO
31100-79J00	DSN3018
31400-52D10	DAN1006
31400-61M00	DAN1316
31400-62M00	DAN1305
31400-79J00	DAN1062
31400-79K00	DAN1143
31400-80G10	DAN1007
31400-80J00	DAN1357
31400-80J01	DAN1357
31400-81A00	DAN1008
31400-85E00	DAN1033

TOYOTA	DENSO
27060-0D140	DAN1021
27060-0D170	DAN1021
27060-0D190	DAN1021
27060-0D191	DAN1021
27060-0D300	DAN1021
27060-0G010	DAN938
27060-0G011	DAN938
27060-0G021	DAN1013
27060-0H200	DAN1052
27060-0J010	DAN962
27060-0J030	DAN962
27060-0L020	DAN1347
27060-0L021	DAN1347
27060-0L022	DAN1347
27060-0L030	DAN1347
27060-0L040	DAN1347
27060-0L050	DAN1347
27060-0L060	DAN1347
27060-0L080	DAN1347
27060-0L081	DAN1347
27060-0L090	DAN1347
27060-0L100	DAN1347
27060-0N020	DAN1076
27060-0N021	DAN1076
27060-0N030	DAN1076
27060-0N031	DAN1076
27060-0N040	DAN1018
27060-0N050	DAN1018
27060-0N090	DAN1094
27060-0N100	DAN1094
27060-0Q010	DAN1035
27060-0Q011	DAN1035
27060-0Q020	DAN1036
27060-0Q021	DAN1036
27060-0Q030	DAN1077
27060-0Q050	DAN1035
27060-0Q060	DAN1020
27060-0Q070	DAN1017
27060-0Q100	DAN1036
27060-0Q120	DAN1035
27060-0Q130	DAN1036
27060-0Q150	DAN1315
27060-0Q151	DAN1315
27060-0R011	DAN1351
27060-0R040	DAN1045
27060-0R050	DAN1351
27060-0R060	DAN938
27060-0R070	DAN1317
27060-0R071	DAN1317
27060-0R080	DAN1013
27060-0R090	DAN1095
27060-0T010	DAN1061
27060-0T020	DAN1019
27060-0T021	DAN1019
27060-0T050	DAN1011
27060-0T051	DAN1011
27060-0T060	DAN1019
27060-0T061	DAN1019
27060-0T080	DAN1057
27060-0T081	DAN1057
27060-0T090	DAN1011
27060-0T091	DAN1011
27060-0T180	DAN1318

TOYOTA	DENSO
27060-0T181	DAN1318
27060-0T190	DAN1096
27060-0T200	DAN1098
27060-0Y010	DAN1025
27060-0Y020	DAN1012
27060-0Y030	DAN1025
27060-0Y040	DAN1012
27060-0Y041	DAN1012
27060-0Y050	DAN1042
27060-0Y060	DAN1015
27060-0Y070	DAN1042
27060-0Y080	DAN1015
27060-0Y090	DAN1012
27060-0Y091	DAN1012
27060-0Y130	DAN1093
27060-0Y141	DAN1100
27060-0Y150	DAN1309
27060-0Y160	DAN1093
27060-17170	DAN1114
27060-17171	DAN1114
27060-17220	DAN1114
27060-21010	DAN966
27060-21011	DAN966
27060-21020	DAN959
27060-21030	DAN959
27060-21031	DAN959
27060-21040	DAN966
27060-21041	DAN966
27060-22020	DAN948
27060-22030	DAN948
27060-22040	DAN948
27060-22060	DAN943
27060-22070	DAN948
27060-22080	DAN944
27060-22100	DAN948
27060-22110	DAN951
27060-22130	DAN948
27060-22140	DAN943
27060-22160	DAN948
27060-22180	DAN948
27060-22200	DAN944
27060-22210	DAN944
27060-22260	DAN1079
27060-23010	DAN960
27060-23020	DAN961
27060-23030	DAN961
27060-23040	DAN962
27060-23070	DAN960
27060-25260	DAN952
27060-26030	DAN1013
27060-26051	DAN1351
27060-26060	DAN1350
27060-26070	DAN938
27060-26081	DAN1350
27060-27030	DAN939
27060-27040	DAN1345
27060-27070	DAN945
27060-27090	DAN945
27060-27100	DAN945
27060-28060	DAN1434
27060-28070	DAN952
27060-28080	DAN1434
27060-28090	DAN1434
27060-28100	DAN1434
27060-28110	DAN951
27060-28120	DAN951
27060-28150	DAN952
27060-28160	DAN952
27060-28170	DAN951
27060-28180	DAN951
27060-28260	DAN952
27060-28280	DAN1282
27060-28330	DAN1052
27060-28340	DAN1482
27060-28341	DAN1482
27060-30010	DAN1347
27060-30020	DAN1349
27060-30030	DAN1349
27060-30040	DAN1347
27060-30050	DAN1347
27060-30060	DAN1070

Starters & Alternators

Cross Reference Chart

TOYOTA	DENSO
27060-30070	DAN1069
27060-30080	DAN1070
27060-30100	DAN1069
27060-30110	DAN1481
27060-30111	DAN1481
27060-30120	DAN1347
27060-30121	DAN1347
27060-30122	DAN1347
27060-30123	DAN1347
27060-30130	DAN1070
27060-30131	DAN1070
27060-30140	DAN1069
27060-30141	DAN1069
27060-30150	DAN1347
27060-30151	DAN1347
27060-30152	DAN1347
27060-30153	DAN1347
27060-30154	DAN1347
27060-30170	DAN1069
27060-30171	DAN1069
27060-30180	DAN1481
27060-30181	DAN1481
27060-30210	DAN1070
27060-30220	DAN1069
27060-31010	DAN1080
27060-31011	DAN1080
27060-31050	DAN1354
27060-31051	DAN1354
27060-31052	DAN1354
27060-31060	DAN1483
27060-31061	DAN1483
27060-31062	DAN1483
27060-31190	DAN1484
27060-31201	DAN1354
27060-31210	DAN1483
27060-31211	DAN1483
27060-31212	DAN1483
27060-31230	DAN1484
27060-33010	DAN964
27060-33020	DAN964
27060-33030	DAN950
27060-33040	DAN950
27060-33050	DAN981
27060-33051	DAN981
27060-33060	DAN981
27060-33070	DAN1076
27060-33071	DAN1076
27060-33072	DAN1076
27060-33100	DAN1018
27060-33110	DAN1094
27060-37010	DAN1019
27060-37011	DAN1019
27060-37050	DAN1011
27060-37051	DAN1011
27060-37101	DAN1098
27060-37210	DAN1098
27060-38040	DAN1281
27060-38041	DAN1281
27060-38050	DAN1208
27060-38070	DAN1281
27060-38090	DAN1205
27060-38110	DAN1205
27060-40020	DAN1077
27060-40040	DAN1020
27060-40041	DAN1020
27060-40050	DAN1017
27060-40060	DAN1081
27060-47010	DAN1042
27060-47020	DAN1015
27060-47030	DAN1012
27060-47031	DAN1012
27060-47040	DAN1212
27060-47050	DAN1025
27060-50340	DAN1279
27060-51030	DAN1209
27060-74360	DAN955
27060-74410	DAN955
27060-74750	DAN955
28100-03100	DSN929
28100-08010	DSN950
28100-08020	DSN950

TOYOTA	DENSO
28100-0D090	DSN920
28100-0D180	DSN920
28100-0G010	DSN950
28100-0G020	DSN950
28100-0G021	DSN950
28100-0G040	DSN984
28100-0H050	DSN1370
28100-0H051	DSN1370
28100-0H060	DSN1370
28100-0H061	DSN1370
28100-0H100	DSN1370
28100-0H110	DSN1370
28100-0J010	DSN931
28100-0J020	DSN931
28100-0J030	DSN980
28100-0J031	DSN980
28100-0J050	DSN980
28100-0L030	DSN1373
28100-0L031	DSN1373
28100-0L032	DSN1373
28100-0L040	DSN1374
28100-0L041	DSN1374
28100-0L042	DSN1374
28100-0L050	DSN1371
28100-0L051	DSN1371
28100-0L052	DSN1371
28100-0N030	DSN926
28100-0N050	DSN946
28100-0N110	DSN1234
28100-0N120	DSN1238
28100-0N121	DSN1238
28100-0Q031	DSN988
28100-0Q040	DSN948
28100-0Q041	DSN948
28100-0Q050	DSN948
28100-0Q080	DSN988
28100-0R010	DSN984
28100-0R030	DSN984
28100-0R060	DSN989
28100-0Y010	DSN949
28100-0Y020	DSN986
28100-0Y021	DSN986
28100-0Y022	DSN986
28100-0Y030	DSN949
28100-0Y040	DSN986
28100-0Y041	DSN986
28100-0Y042	DSN986
28100-0Y090	DSN1009
28100-0Y091	DSN1009
28100-0Y100	DSN1009
28100-0Y101	DSN1009
28100-0Y110	DSN987
28100-0Y190	DSN1472
28100-0Y200	DSN1473
28100-0Y240	DSN1475
28100-17050	DSN1228
28100-17051	DSN1228
28100-20020	DSN1003
28100-20021	DSN1003
28100-20022	DSN1003
28100-21020	DSN934
28100-21021	DSN934
28100-21030	DSN934
28100-21031	DSN934
28100-21040	DSN935
28100-21060	DSN936
28100-21061	DSN936
28100-21062	DSN936
28100-21063	DSN936
28100-22030	DSN921
28100-22031	DSN921
28100-22040	DSN921
28100-22041	DSN921
28100-23020	DSN931
28100-23030	DSN931
28100-23031	DSN931
28100-23040	DSN931
28100-26180	DSN1235
28100-26181	DSN1235
28100-26190	DSN989
28100-28010	DSN922

TOYOTA	DENSO
28100-28041	DSN1003
28100-28042	DSN1003
28100-28050	DSN1003
28100-28051	DSN1003
28100-28052	DSN1003
28100-28053	DSN1003
28100-28060	DSN1003
28100-28061	DSN1003
28100-28062	DSN1003
28100-28070	DSN1003
28100-28071	DSN1003
28100-28072	DSN1003
28100-28080	DSN1003
28100-28081	DSN1003
28100-28082	DSN1003
28100-30040	DSN1001
28100-30050	DSN1229
28100-30051	DSN1229
28100-30060	DSN1001
28100-30080	DSN1229
28100-30081	DSN1229
28100-31040	DSN1220
28100-31041	DSN1220
28100-31050	DSN978
28100-31070	DSN1256
28100-31071	DSN1256
28100-31100	DSN1003
28100-31101	DSN1003
28100-31102	DSN1003
28100-31130	DSN1241
28100-31131	DSN1241
28100-33040	DSN937
28100-33050	DSN937
28100-33070	DSN926
28100-33071	DSN926
28100-33080	DSN926
28100-33120	DSN946
28100-33121	DSN946
28100-37020	DSN1213
28100-37021	DSN1213
28100-37030	DSN1213
28100-37031	DSN1213
28100-37032	DSN1213
28100-37090	DSN1239
28100-37110	DSN1239
28100-38020	DSN1222
28100-38021	DSN1222
28100-38030	DSN1222
28100-38031	DSN1222
28100-38050	DSN1236
28100-38070	DSN1236
28100-40070	DSN988
28100-40071	DSN988
28100-40090	DSN948
28100-40091	DSN948
28100-40120	DSN1221
28100-40121	DSN1221
28100-40130	DSN1215
28100-40131	DSN1215
28100-40140	DSN948
28100-47110	DSN986
28100-47111	DSN986
28100-47112	DSN986
28100-47120	DSN949
28100-47121	DSN949
28100-47122	DSN949
28100-47130	DSN949
28100-47131	DSN949
28100-47132	DSN949
28100-47170	DSN1009
28100-47171	DSN1009
28100-47180	DSN1009
28100-47190	DSN987
28100-50080	DSN1223
28100-50081	DSN1223
28100-50110	DSN1223
28100-51070	DSN1210
28100-51071	DSN1210
28100-51072	DSN1210
28100-64300	DSN928
28100-64310	DSN928

TOYOTA	DENSO
28100-64340	DSN1224
28100-64341	DSN1224
28100-64430	DSN928
28100-67050	DSN1211
28100-67051	DSN1211
28100-67052	DSN1211
28100-67070	DSN1229
28100-70030	DSN999
28100-70050	DSN999
28100-74130	DSN923
28100-74260	DSN929
28100-74270	DSN929
28100-75090	DSN1225
28100-75091	DSN1225
28100-75130	DSN1225

VAUXHALL	DENSO
12 02 229	DSN1008
12 02 504	DSN1008
55572439	DSN1008
90512467	DSN3017
9200962	DSN3017
93171526	DSN3017
93171936	DSN3009
93176034	DSN3017
93184533	DSN3009
95520337	DSN1008
R1030085	DAN1343
R1030086	DAN1343
R1040027	DAN1488
R1530001	DAN1342
R1530024	DAN1341
R1530029	DAN1342
R1530035	DAN1341
R1530052	DAN1342
R1530061	DAN1488
R1530077	DAN1341
R1530079	DAN1341
R1530082	DAN1341
R1530096	DAN1033
R1530097	DAN1032
R1530098	DAN510
R1530099	DAN509
R1530100	DAN506
R1540005	DSN3017
R1540019	DSN1488
R1610391	DAN1341

VOLKSWAGEN	DENSO
02E 911 022 C	DSN1460
02E 911 022 CX	DSN1460
02E 911 023 M	DSN1464
02E 911 023 MX	DSN1464
02E 911 023 Q	DSN1460
02E 911 023 QX	DSN1460
02E 911 023 T	DSN1460
02E 911 023 TX	DSN1460
02E 911 024 B	DSN1464
02E 911 024 BX	DSN1464
02E 911 024 C	DSN1460
02E 911 024 CX	DSN1460
02E 911 024 D	DSN1464
02E 911 024 DX	DSN1464
02E 911 024 H	DSN1460
02E 911 024 HK	DSN1460
02E 911 024 J	DSN1460
02E 911 024 JX	DSN1460
02E 911 024 M	DSN1464
02E 911 024 MX	DSN1464
02E 911 024 P	DSN1464
02E 911 024 PX	DSN1464
02M 911 021 E	DSN1461
02M 911 021 EX	DSN1461
02M 911 021 G	DSN1468
02M 911 021 GX	DSN1468
02M 911 021 P	DSN1461
02M 911 021 PX	DSN1461
02M 911 024 B	DSN1461
02M 911 024 BX	DSN1461
02M 911 024 C	DSN1461
02M 911 024 CX	DSN1461

Starters & Alternators

Cross Reference Chart

VOLKSWAGEN	DENSO
02M 911 024 F	DSN1461
02M 911 024 FX	DSN1461
02M 911 024 G	DSN1461
02M 911 024 GX	DSN1461
02M 911 024 H	DSN962
02M 911 024 HX	DSN962
02M 911 024 J	DSN1468
02M 911 024 JX	DSN1468
02M 911 024 Q	DSN1468
02M 911 024 QX	DSN1468
02M 911 024 S	DSN1461
02M 911 024 SX	DSN1461
02Z 911 021 C	DSN1462
02Z 911 021 CX	DSN1462
02Z 911 021 K	DSN1462
02Z 911 021 KX	DSN1462
02Z 911 023 M	DSN963
02Z 911 023 MX	DSN963
02Z 911 023 N	DSN963
02Z 911 023 NX	DSN963
02Z 911 023 P	DSN963
02Z 911 023 PX	DSN963
02Z 911 023 S	DSN1462
02Z 911 023 SX	DSN1462
02Z 911 024	DSN1466
02Z 911 024 A	DSN1462
02Z 911 024 AX	DSN1462
02Z 911 024 B	DSN1462
02Z 911 024 BX	DSN1462
02Z 911 024 H	DSN1462
02Z 911 024 HX	DSN1462
02Z 911 024 K	DSN963
02Z 911 024 KX	DSN963
02Z 911 024 L	DSN1462
02Z 911 024 LX	DSN1462
02Z 911 024 X	DSN1466
03L 903 023	DAN1328
03L 903 023 A	DAN1328
03L 903 023 AX	DAN1328
03L 903 023 X	DAN1328
03L 903 024	DAN1328
03L 903 024 M	DAN1328
03L 903 024 MX	DAN1328
03L 903 024 X	DAN1328
059 911 024 K	DSN965
059 911 024 KX	DSN965
09A 911 023	DSN957
09A 911 023 A	DSN958
09A 911 023 B	DSN958
09A 911 023 BX	DSN958
09A 911 023 X	DSN957
0AH 911 023 F	DSN1467
0AH 911 023 F	DSN964
0AH 911 023 FX	DSN1467
0AH 911 023 FX	DSN964
0AH 911 023 G	DSN1467
0AH 911 023 GX	DSN1467
0AH 911 023 J	DSN1467
0AH 911 023 JX	DSN1467
0AM 911 021 B	DSN1463
0AM 911 021 BX	DSN1463
0AM 911 021 E	DSN1463
0AM 911 021 EX	DSN1463
0AM 911 023 G	DSN1463
0AM 911 023 GX	DSN1463
0AM 911 023 H	DSN1463
0AM 911 023 HX	DSN1463
0AM 911 023 J	DSN1463
0AM 911 023 JX	DSN1463
0AM 911 023 M	DSN1463
0AM 911 023 MX	DSN1463
0AM 911 023 N	DSN1465
0AM 911 023 NX	DSN1465
0AM 911 023 R	DSN1465
0AM 911 023 RX	DSN1465
0AM 911 024 A	DSN1465
0AM 911 024 AX	DSN1465

VOLVO	DENSO
30659346	DAN1059
30659369	DAN1059

VOLVO	DENSO
30659513	DSN3001
30667067	DAN1119
30667068	DAN930
30667069	DAN1023
30667070	DAN931
30667071	DAN1016
30667072	DAN934
30667102	DSN3001
30667103	DAN1059
30667501	DAN1041
30737529	DAN1059
30795422	DAN1119
30795423	DAN930
30795493	DAN1041
30795494	DAN1016
30795495	DAN934
31285592	DAN1139
31285593	DAN1118
31285594	DAN1119
31285595	DAN930
31285782	DSN3001
31288154	DAN1139
31288155	DAN1118
31288275	DSN3001
32544534	DSN3001
36000598	DAN1119
36000599	DAN930
36001463	DAN1059
36002573	DAN1041
36002574	DAN1016
36002575	DAN934
36002577	DAN1118
36002761	DSN3001
8603182	DAN1119
8603183	DAN930
8603271	DAN1016
8603272	DAN934
8603377	DSN3001
8603496	DAN1059
8603604	DAN1041
8666581	DAN1023
8676015	DAN1059

VW	DENSO
02B 911 023 D	DSN3016
02B 911 023 J	DSN3016
02B 911 023 L	DSN3016
02B 911 023 N	DSN3016
02E 911 023 H	DSN3008
02E 911 023 HX	DSN3008
02M 911 021 B	DSN3005
02M 911 021 BX	DSN3005
02M 911 023 G	DSN3005
02M 911 023 GX	DSN3005
02M 911 023 M	DSN3005
02M 911 023 MX	DSN3005
02T 911 023 R	DSN3006
02T 911 023 RX	DSN3006
02T 911 023 S	DSN3006
02T 911 024 A	DSN3006
02T 911 024 B	DSN3006
02T 911 024 C	DSN3006
02T 911 024 K	DSN3006
02T 911 024 N	DSN3006
02Z 911 023 F	DSN3007
02Z 911 023 FX	DSN3007
02Z 911 023 H	DSN3007
02Z 911 023 HX	DSN3007
02Z 911 024 J	DSN3007
02Z 911 024 JX	DSN3007
068 911 023 P	DSN3015
068 911 023 R	DSN3015
068 911 023 S	DSN3015
068 911 024 B	DSN3015
068 911 024 C	DSN3015
068 911 024 E	DSN3015
068 911 024 F	DSN3015
068 911 024 G	DSN3015

Starters & Alternators

Cross Reference Chart

DENSO	DENSO
104210-9030	DAN1487
104210-9031	DAN1487
104210-9032	DAN1487
104210-9033	DAN1487
438000-0092	DSN1205
021080-0010	DAN985
021080-0020	DAN1143
021080-0070	DAN1102
021080-0080	DAN1103
021080-0090	DAN1104
021080-0100	DAN1106
021080-0110	DAN991
021080-0120	DAN986
021080-0130	DAN987
021080-0150	DAN988
021080-0160	DAN989
021080-0180	DAN990
021080-0200	DAN1059
021080-0220	DAN1111
021080-0230	DAN1112
021080-0250	DAN1110
021080-0270	DAN1375
021080-0340	DAN1488
021080-0360	DAN972
021080-0370	DAN1007
021080-0380	DAN944
021080-0410	DAN1114
021080-0440	DAN955
021080-0450	DAN948
021080-0530	DAN1008
021080-0540	DAN970
021080-0550	DAN976
021080-0560	DAN978
021080-0600	DAN1006
021080-0610	DAN1077
021080-0620	DAN1079
021080-0630	DAN979
021080-0640	DAN980
021080-0660	DAN1080
021080-0850	DAN968
021080-0910	DAN969
021080-0930	DAN973
021080-0940	DAN974
021080-0970	DAN971
021080-1000	DAN975
021080-1010	DAN985
021080-1090	DAN1133
021080-1100	DAN1135
021080-1110	DAN1201
021080-1120	DAN1081
021080-1130	DAN1125
021080-1140	DAN1126
021080-1150	DAN1127
021080-1160	DAN1282
021080-1240	DAN1137
021080-1250	DAN1138
021080-1260	DAN1202
021080-1270	DAN1203
021080-1280	DAN1205
021080-1290	DAN1208
021080-1300	DAN1209
021080-1320	DAN1212
021080-1330	DAN1279
021080-1350	DAN1281
021080-1360	DAN1105
021080-1610	DAN1148
021080-1690	DAN1347
021080-1700	DAN1349
021080-2000	DAN1345
021080-2010	DAN1351
021080-2040	DAN1052
021080-2060	DAN1370
021080-2070	DAN1376
021080-2080	DAN1375
021080-2090	DAN1357
021080-2240	DAN1462
021080-2250	DAN1464
021080-2260	DAN1466
021080-2270	DAN1468
021080-2280	DAN1469
021080-2290	DAN1471

DENSO	DENSO
021080-2300	DAN1429
021080-2310	DAN1330
021080-2320	DAN1431
021080-2330	DAN1103
021080-2331	DAN1103
021080-2340	DAN1322
021080-2350	DAN1331
021080-2360	DAN1334
021080-2440	DAN1354
021080-2450	DAN1069
021080-2460	DAN1070
021080-2470	DAN1350
021080-6000	DAN981
021080-6010	DAN1013
021080-6020	DAN950
021080-6030	DAN964
021080-6040	DAN945
021080-6050	DAN1076
021080-6060	DAN938
100211-1640	DAN968
100213-2530	DAN670
101210-0160	DAN1009
101210-0161	DAN1009
101210-0162	DAN1009
101210-0840	DAN1343
101210-0850	DAN1341
101210-0860	DAN1342
101210-0870	DAN1365
101210-0871	DAN1365
101210-0890	DAN1021
101210-0891	DAN1021
101210-0910	DAN1061
101210-0911	DAN1061
101210-0912	DAN1061
101210-0920	DAN582
101210-0921	DAN582
101210-0922	DAN582
101210-0940	DAN1055
101210-0941	DAN1340
101210-0950	DAN583
101210-0951	DAN583
101210-0960	DAN584
101210-0961	DAN584
101210-0970	DAN585
101210-0971	DAN585
101210-0990	DAN1062
101210-1080	DAN993
101210-1081	DAN993
101210-1090	DAN994
101210-1091	DAN994
101210-1100	DAN995
101210-1101	DAN995
101210-1110	DAN996
101210-1111	DAN996
101210-1120	DAN996
101210-1121	DAN996
101210-1130	DAN1141
101210-1131	DAN1141
101210-1132	DAN1141
101210-1180	DAN1002
101210-1181	DAN1002
101210-1190	DAN1002
101210-1191	DAN1002
101210-1200	DAN997
101210-1201	DAN997
101210-1210	DAN1003
101210-1211	DAN1003
101210-1220	DAN1001
101210-1221	DAN1001
101210-1270	DAN1001
101210-1271	DAN1001
101210-1320	DAN1000
101210-1321	DAN1000
101210-1322	DAN1000
101210-1330	DAN1083
101210-1331	DAN1083
101210-1340	DAN1057
101210-1341	DAN1057
101210-1380	DAN999
101210-1381	DAN999
101210-1390	DAN997

DENSO	DENSO
101210-1391	DAN997
101210-1400	DAN1035
101210-1410	DAN1036
101210-1420	DAN1141
101210-1421	DAN1141
101210-1422	DAN1141
101210-1430	DAN1147
101210-1440	DAN1084
101210-1450	DAN993
101210-1470	DAN1085
101210-1480	DAN631
101210-1500	DAN520
101210-1510	DAN501
101210-1631	DAN1147
101210-1640	DAN1066
101210-1660	DAN1078
101210-1670	DAN1078
101210-1700	DAN1086
101210-1710	DAN1121
101210-1720	DAN1071
101210-1721	DAN1071
101210-1750	DAN1096
101210-1830	DAN1078
101210-1840	DAN1078
101210-1860	DAN632
101210-1870	DAN502
101210-1880	DAN1140
101210-1890	DAN513
101210-1900	DAN1305
101211-2270	DAN969
101211-2730	DAN973
101211-2731	DAN973
101211-2750	DAN974
101211-2751	DAN974
101211-2870	DAN971
101211-5010	DAN955
101211-5230	DAN955
101211-5260	DAN1114
101211-5261	DAN1114
101211-7400	DAN1434
101211-7410	DAN1434
101211-7550	DAN671
101211-7551	DAN671
101211-7630	DAN672
101211-7631	DAN672
101211-7632	DAN672
101211-7633	DAN672
101211-9920	DAN673
101211-9930	DAN674
101211-9931	DAN674
102211-0670	DAN939
102211-0750	DAN952
102211-0770	DAN1434
102211-0780	DAN1434
102211-0860	DAN1407
102211-0910	DAN952
102211-0920	DAN952
102211-0921	DAN952
102211-0980	DAN1408
102211-0981	DAN1408
102211-1240	DAN955
102211-1360	DAN1114
102211-1361	DAN1114
102211-1362	DAN1114
102211-1630	DAN972
102211-1670	DAN961
102211-1680	DAN961
102211-1740	DAN1488
102211-1900	DAN948
102211-1910	DAN948
102211-1920	DAN948
102211-1950	DAN959
102211-1951	DAN959
102211-1960	DAN959
102211-1990	DAN944
102211-2020	DAN948
102211-2060	DAN948
102211-2120	DAN951
102211-2170	DAN972
102211-2180	DAN948
102211-2250	DAN951

DENSO	DENSO
102211-2290	DAN948
102211-2310	DAN1347
102211-2340	DAN948
102211-2350	DAN944
102211-2351	DAN944
102211-2380	DAN951
102211-2390	DAN951
102211-2420	DAN944
102211-2421	DAN944
102211-2600	DAN1007
102211-2770	DAN950
102211-2780	DAN950
102211-2810	DAN1347
102211-4120	DAN939
102211-5230	DAN1008
102211-5231	DAN1008
102211-5250	DAN960
102211-5260	DAN966
102211-5261	DAN966
102211-5270	DAN970
102211-5300	DAN962
102211-5360	DAN943
102211-5410	DAN960
102211-5450	DAN976
102211-5460	DAN978
102211-5600	DAN1349
102211-5640	DAN943
102211-5650	DAN964
102211-5660	DAN964
102211-5670	DAN1349
102211-5930	DAN966
102211-5940	DAN966
102211-6150	DAN960
102211-6170	DAN962
102211-6180	DAN943
102211-6200	DAN964
102211-6210	DAN966
102211-7050	DAN975
102211-8000	DAN962
102211-8030	DAN562
102211-8031	DAN562
102211-8040	DAN588
102211-8041	DAN588
102211-8042	DAN588
102211-8050	DAN588
102211-8051	DAN588
102211-8052	DAN588
102211-8053	DAN588
102211-8060	DAN1124
102211-8061	DAN1124
102211-8070	DAN1124
102211-8071	DAN1124
102211-8080	DAN562
102211-8081	DAN562
102211-8190	DAN962
102211-8230	DAN517
102211-8260	DAN513
102211-8270	DAN1062
102211-8280	DAN998
102211-8281	DAN998
102211-8350	DAN588
102211-8351	DAN588
102211-8352	DAN588
102211-8353	DAN588
102211-8354	DAN588
102211-8355	DAN588
102211-8356	DAN588
102211-8400	DAN1336
102211-8410	DAN515
102211-8430	DAN517
102211-8431	DAN517
102211-8440	DAN517
102211-8441	DAN517
102211-8450	DAN519
102211-8451	DAN519
102211-8460	DAN599
102211-8461	DAN599
102211-8470	DAN519
102211-8471	DAN519
102211-8480	DAN599
102211-8481	DAN599

Starters & Alternators

Cross Reference Chart

DENSO	DENSO
102211-8500	DAN1021
102211-8610	DAN1032
102211-8611	DAN1032
102211-8612	DAN1032
102211-8620	DAN1033
102211-8621	DAN1033
102211-8622	DAN1033
102211-8630	DAN1034
102211-8631	DAN1034
102211-8640	DAN510
102211-8641	DAN510
102211-8642	DAN510
102211-8650	DAN506
102211-8651	DAN506
102211-8652	DAN506
102211-8660	DAN509
102211-8661	DAN509
102211-8662	DAN509
102211-8680	DAN1004
102211-8681	DAN1004
102211-8690	DAN1005
102211-8691	DAN1005
102211-8730	DAN1035
102211-8731	DAN1035
102211-8740	DAN1036
102211-8741	DAN1036
102211-9030	DAN959
102211-9070	DAN959
102211-9071	DAN959
102211-9260	DAN1357
102211-9261	DAN1357
102211-9280	DAN1021
102211-9380	DAN955
102211-9400	DAN955
102211-9410	DAN961
102211-9420	DAN961
102211-9430	DAN948
102211-9450	DAN959
102211-9460	DAN948
102211-9470	DAN951
102211-9480	DAN948
102211-9490	DAN944
102211-9520	DAN950
102211-9540	DAN959
102211-9630	DAN1124
104210-1060	DAN1102
104210-1090	DAN1483
104210-1091	DAN1483
104210-1092	DAN1483
104210-1190	DAN1329
104210-1200	DAN1123
104210-1360	DAN952
104210-1370	DAN1094
104210-1371	DAN1094
104210-1372	DAN1094
104210-1373	DAN1094
104210-1430	DAN1069
104210-1431	DAN1069
104210-1440	DAN1481
104210-1470	DAN1103
104210-1471	DAN1103
104210-1510	DAN1104
104210-1540	DAN1370
104210-1730	DAN1073
104210-1731	DAN1073
104210-1780	DAN1069
104210-1781	DAN1069
104210-1782	DAN1069
104210-1783	DAN1069
104210-1790	DAN1481
104210-1830	DAN1012
104210-1831	DAN1012
104210-1832	DAN1012
104210-1833	DAN1012
104210-1860	DAN1070
104210-1861	DAN1070
104210-1862	DAN1070
104210-1863	DAN1070
104210-1870	DAN1069
104210-1871	DAN1069
104210-1872	DAN1069

DENSO	DENSO
104210-1873	DAN1069
104210-1880	DAN1013
104210-1881	DAN1013
104210-1882	DAN1013
104210-1930	DAN1012
104210-1931	DAN1012
104210-1932	DAN1012
104210-1940	DAN1012
104210-1941	DAN1012
104210-1942	DAN1012
104210-1970	DAN1074
104210-1971	DAN1074
104210-2040	DAN1354
104210-2041	DAN1354
104210-2042	DAN1354
104210-2043	DAN1354
104210-2050	DAN1483
104210-2051	DAN1483
104210-2052	DAN1483
104210-2053	DAN1483
104210-2180	DAN1011
104210-2181	DAN1011
104210-2182	DAN1011
104210-2183	DAN1011
104210-2190	DAN1052
104210-2220	DAN1045
104210-2290	DAN1017
104210-2291	DAN1017
104210-2300	DAN1012
104210-2310	DAN1012
104210-2320	DAN1018
104210-2321	DAN1018
104210-2322	DAN1018
104210-2370	DAN1350
104210-2371	DAN1350
104210-2380	DAN1011
104210-2381	DAN1011
104210-2382	DAN1011
104210-2383	DAN1011
104210-2384	DAN1011
104210-2390	DAN938
104210-2400	DAN1011
104210-2401	DAN1011
104210-2402	DAN1011
104210-2403	DAN1011
104210-2410	DAN938
104210-2411	DAN938
104210-2412	DAN938
104210-2420	DAN1105
104210-2421	DAN1105
104210-2422	DAN1105
104210-2430	DAN1017
104210-2431	DAN1017
104210-2450	DAN1143
104210-2470	DAN1015
104210-2471	DAN1015
104210-2472	DAN1015
104210-2480	DAN1015
104210-2481	DAN1015
104210-2482	DAN1015
104210-2483	DAN1015
104210-2490	DAN1012
104210-2500	DAN1015
104210-2501	DAN1015
104210-2502	DAN1015
104210-2510	DAN1012
104210-2520	DAN1018
104210-2521	DAN1018
104210-2522	DAN1018
104210-2530	DAN1018
104210-2531	DAN1018
104210-2532	DAN1018
104210-2710	DAN930
104210-2720	DAN931
104210-2730	DAN932
104210-2740	DAN933
104210-2750	DAN934
104210-2770	DAN935
104210-2780	DAN936
104210-2810	DAN1106
104210-2811	DAN1106

DENSO	DENSO
104210-2830	DAN1205
104210-2831	DAN1205
104210-2832	DAN1205
104210-2860	DAN1484
104210-2861	DAN1484
104210-2862	DAN1484
104210-2863	DAN1484
104210-2864	DAN1484
104210-2865	DAN1484
104210-3050	DAN1345
104210-3051	DAN1345
104210-3052	DAN1345
104210-3250	DAN945
104210-3251	DAN945
104210-3252	DAN945
104210-3253	DAN945
104210-3254	DAN945
104210-3290	DAN1375
104210-3291	DAN1375
104210-3292	DAN1375
104210-3293	DAN1375
104210-3410	DAN1070
104210-3411	DAN1070
104210-3420	DAN1069
104210-3421	DAN1069
104210-3422	DAN1069
104210-3423	DAN1069
104210-3430	DAN945
104210-3431	DAN945
104210-3510	DAN1119
104210-3511	DAN1119
104210-3512	DAN1119
104210-3513	DAN1119
104210-3514	DAN1119
104210-3520	DAN930
104210-3521	DAN930
104210-3522	DAN930
104210-3523	DAN930
104210-3524	DAN930
104210-3530	DAN1023
104210-3531	DAN1023
104210-3532	DAN1023
104210-3540	DAN931
104210-3541	DAN931
104210-3542	DAN931
104210-3550	DAN1059
104210-3551	DAN1059
104210-3560	DAN1059
104210-3640	DAN932
104210-3641	DAN932
104210-3642	DAN932
104210-3690	DAN991
104210-3691	DAN991
104210-3692	DAN991
104210-3700	DAN986
104210-3701	DAN986
104210-3710	DAN987
104210-3711	DAN987
104210-3730	DAN981
104210-3731	DAN981
104210-3732	DAN981
104210-3740	DAN981
104210-3741	DAN981
104210-3760	DAN1016
104210-3761	DAN1016
104210-3762	DAN1016
104210-3780	DAN952
104210-3781	DAN952
104210-3821	DAN934
104210-3850	DAN933
104210-3851	DAN933
104210-3852	DAN933
104210-3910	DAN985
104210-3911	DAN985
104210-3950	DAN988
104210-3951	DAN988
104210-3980	DAN945
104210-3981	DAN945
104210-4000	DAN1279
104210-4001	DAN1279
104210-4002	DAN1279

DENSO	DENSO
104210-4010	DAN989
104210-4011	DAN989
104210-4012	DAN989
104210-4020	DAN1041
104210-4022	DAN1041
104210-4100	DAN1076
104210-4101	DAN1076
104210-4102	DAN1076
104210-4320	DAN936
104210-4321	DAN936
104210-4450	DAN1069
104210-4451	DAN1069
104210-4460	DAN1070
104210-4500	DAN1481
104210-4501	DAN1481
104210-4502	DAN1481
104210-4503	DAN1481
104210-4520	DAN938
104210-4521	DAN938
104210-4522	DAN938
104210-4523	DAN938
104210-4590	DAN1013
104210-4591	DAN1013
104210-4592	DAN1013
104210-4640	DAN1059
104210-4650	DAN990
104210-4651	DAN990
104210-4670	DAN1354
104210-4680	DAN1483
104210-4730	DAN1375
104210-4731	DAN1375
104210-4732	DAN1375
104210-4760	DAN1052
104210-4761	DAN1052
104210-4770	DAN1013
104210-4771	DAN1013
104210-4840	DAN935
104210-4850	DAN1351
104210-4860	DAN985
104210-4880	DAN1482
104210-4881	DAN1482
104210-4882	DAN1482
104210-4883	DAN1482
104210-4884	DAN1482
104210-4885	DAN1482
104210-5020	DAN936
104210-5021	DAN936
104210-5050	DAN1201
104210-5140	DAN1351
104210-5150	DAN1076
104210-5151	DAN1076
104210-5290	DAN1019
104210-5291	DAN1019
104210-5292	DAN1019
104210-5293	DAN1019
104210-5294	DAN1019
104210-5350	DAN1019
104210-5351	DAN1019
104210-5352	DAN1019
104210-5353	DAN1019
104210-5360	DAN1103
104210-5361	DAN1103
104210-5362	DAN1103
104210-5363	DAN1103
104210-5370	DAN1148
104210-5440	DAN1070
104210-5441	DAN1070
104210-5442	DAN1070
104210-5450	DAN1069
104210-5451	DAN1069
104210-5452	DAN1069
104210-5580	DAN1019
104210-5581	DAN1019
104210-5590	DAN1076
104210-5591	DAN1076
104210-5600	DAN1351
104210-5700	DAN1139
104210-5701	DAN1139
104210-5710	DAN1118
104210-5711	DAN1118
104210-5740	DAN1059

Starters & Alternators

Cross Reference Chart

DENSO	DENSO
104210-5760	DAN1041
104210-5770	DAN934
104210-5780	DAN931
104210-5790	DAN1016
104210-5800	DAN1023
104210-5890	DAN1376
104210-6130	DAN1281
104210-6131	DAN1281
104210-6132	DAN1281
104210-6133	DAN1281
104210-6134	DAN1281
104210-6140	DAN1208
104210-6141	DAN1208
104210-6142	DAN1208
104210-6143	DAN1208
104210-6150	DAN1209
104210-6151	DAN1209
104210-6152	DAN1209
104210-6153	DAN1209
104210-6280	DAN1110
104210-6330	DAN1125
104210-6331	DAN1125
104210-6332	DAN1125
104210-6333	DAN1125
104210-6334	DAN1125
104210-6360	DAN1111
104210-6361	DAN1111
104210-6390	DAN1126
104210-6391	DAN1126
104210-6392	DAN1126
104210-6393	DAN1126
104210-6394	DAN1126
104210-6395	DAN1126
104210-6400	DAN1127
104210-6401	DAN1127
104210-6402	DAN1127
104210-6403	DAN1127
104210-6404	DAN1127
104210-6405	DAN1127
104210-6406	DAN1127
104210-6420	DAN1112
104210-6421	DAN1112
104210-6440	DAN1138
104210-6441	DAN1138
104210-6442	DAN1138
104210-6500	DAN1135
104210-6501	DAN1135
104210-6502	DAN1135
104210-6503	DAN1135
104210-6504	DAN1135
104210-6510	DAN1137
104210-6511	DAN1137
104210-6512	DAN1137
104210-6513	DAN1137
104210-6514	DAN1137
104210-6520	DAN1133
104210-6521	DAN1133
104210-6522	DAN1133
104210-6620	DAN1203
104210-6640	DAN1202
104210-6641	DAN1202
104210-6720	DAN1464
104210-6721	DAN1464
104210-6722	DAN1464
104210-6740	DAN1468
104210-6741	DAN1468
104210-6742	DAN1468
104210-6780	DAN1281
104210-6781	DAN1281
104210-6782	DAN1281
104210-6783	DAN1281
104210-6980	DAN1469
104210-6981	DAN1469
104210-6982	DAN1469
104210-6983	DAN1469
104210-8020	DAN1347
104210-8021	DAN1347
104210-8022	DAN1347
104210-8023	DAN1347
104210-8040	DAN1080
104210-8100	DAN1282

DENSO	DENSO
104210-8101	DAN1282
104210-8140	DAN1006
104210-8160	DAN1077
104210-8161	DAN1077
104210-8190	DAN1079
104210-8191	DAN1079
104210-8200	DAN979
104210-8201	DAN979
104210-8202	DAN979
104210-8210	DAN980
104210-8211	DAN980
104210-8212	DAN980
104210-8220	DAN1347
104210-8221	DAN1347
104210-8222	DAN1347
104210-8240	DAN1347
104210-8241	DAN1347
104210-8242	DAN1347
104210-8243	DAN1347
104210-8280	DAN1042
104210-8281	DAN1042
104210-8290	DAN1042
104210-8291	DAN1042
104210-8310	DAN1081
104210-8311	DAN1081
104210-8320	DAN1020
104210-8321	DAN1020
104210-8330	DAN1212
104210-8331	DAN1212
104210-8350	DAN1025
104210-8351	DAN1025
104210-8360	DAN1347
104210-8361	DAN1347
104210-8370	DAN1347
104210-8410	DAN1080
104210-8411	DAN1080
104210-9010	DAN1347
104210-9011	DAN1347
104210-9230	DAN1347
104210-9231	DAN1347
104210-9240	DAN1020
104210-9250	DAN1025
104210-9260	DAN1042
104210-9261	DAN1042
104210-9290	DAN1025
104210-9340	DAN1347
104210-9341	DAN1347
104210-9342	DAN1347
104210-9343	DAN1347
104210-9350	DAN1347
104210-9351	DAN1347
104210-9410	DAN1347
104210-9630	DAN1100
104210-9840	DAN1487
104210-9841	DAN1487
104211-0590	DAN1462
104211-0591	DAN1462
104211-0600	DAN1466
104211-0601	DAN1466
104211-0610	DAN1471
104211-0611	DAN1471
104211-3000	DAN1094
104211-3001	DAN1094
104211-3002	DAN1094
104211-3010	DAN1315
104211-3011	DAN1315
104211-3012	DAN1315
104211-3020	DAN1093
104211-3021	DAN1093
104211-3022	DAN1093
104211-3050	DAN1318
104211-3051	DAN1318
104211-3052	DAN1318
104211-3060	DAN1317
104211-3061	DAN1317
104211-3062	DAN1317
104211-3090	DAN1093
104211-3100	DAN1309
104211-3110	DAN1098
104211-3130	DAN1094
104211-3140	DAN1095

DENSO	DENSO
104211-3180	DAN1310
104211-3190	DAN1311
104211-3191	DAN1311
104211-3200	DAN1098
104211-3201	DAN1098
104211-3202	DAN1098
104211-3203	DAN1098
104211-3250	DAN1089
104211-3320	DAN1312
104211-3330	DAN1313
104211-3380	DAN1315
104211-3400	DAN1316
104211-3410	DAN1317
104211-3420	DAN1318
104211-3550	DAN1098
104211-3590	DAN1322
104211-3730	DAN1429
104211-8040	DAN1326
104211-8090	DAN1483
104211-8091	DAN1483
104211-8092	DAN1483
104211-8093	DAN1483
104211-8120	DAN1350
104211-8121	DAN1350
104211-8122	DAN1350
104211-8210	DAN1325
104211-8211	DAN1325
104211-8260	DAN1484
104211-8261	DAN1484
104211-8262	DAN1484
104211-8263	DAN1484
104211-8264	DAN1484
104211-8280	DAN1326
104211-8380	DAN1328
104211-8480	DAN1329
104211-8500	DAN1330
104211-8501	DAN1330
104211-8530	DAN1123
104211-8531	DAN1123
104211-8540	DAN1145
104211-8550	DAN1331
104211-8640	DAN1205
104211-8641	DAN1205
104211-8650	DAN1332
104211-8660	DAN1146
104211-8740	DAN1070
104211-8741	DAN1070
104211-8742	DAN1070
104211-8750	DAN1069
104211-8751	DAN1069
104211-8830	DAN1334
104211-8980	DAN1103
104211-8981	DAN1103
104211-9190	DAN1431
104212-4403	DAN005
128000-9700	DSN1488
128000-9701	DSN1488
128000-9702	DSN1488
128080-9702	DSN1488
228000-0550	DSN999
228000-0551	DSN999
228000-0552	DSN999
228000-0810	DSN1488
228000-0811	DSN1488
228000-0820	DSN923
228000-0821	DSN923
228000-0822	DSN923
228000-0823	DSN923
228000-2570	DSN1225
228000-2571	DSN1225
228000-2572	DSN1225
228000-2573	DSN1225
228000-2574	DSN1225
228000-3280	DSN1225
228000-3281	DSN1225
228000-3282	DSN1225
228000-3283	DSN1225
228000-3620	DSN928
228000-3621	DSN928
228000-3622	DSN928
228000-3640	DSN928

DENSO	DENSO
228000-3641	DSN928
228000-3642	DSN928
228000-3643	DSN928
228000-3980	DSN604
228000-3981	DSN604
228000-4970	DSN1224
228000-4971	DSN1224
228000-4972	DSN1224
228000-4973	DSN1224
228000-5020	DSN1211
228000-5021	DSN1211
228000-5022	DSN1211
228000-5023	DSN1211
228000-5024	DSN1211
228000-5025	DSN1211
228000-5090	DSN605
228000-5091	DSN605
228000-5092	DSN605
228000-5093	DSN605
228000-5340	DSN1229
228000-5341	DSN1229
228000-5342	DSN1229
228000-5343	DSN1229
228000-5344	DSN1229
228000-5345	DSN1229
228000-5346	DSN1229
228000-5347	DSN1229
228000-5348	DSN1229
228000-5349	DSN1229
228000-5350	DSN1229
228000-5351	DSN1229
228000-5352	DSN1229
228000-5353	DSN1229
228000-5354	DSN1229
228000-5355	DSN1229
228000-5356	DSN1229
228000-5357	DSN1229
228000-5358	DSN1229
228000-5359	DSN1229
228000-5360	DSN1229
228000-5361	DSN1229
228000-5362	DSN1229
228000-5363	DSN1229
228000-5364	DSN1229
228000-5365	DSN1229
228000-5366	DSN1229
228000-5367	DSN1229
228000-5368	DSN1229
228000-5369	DSN1229
228000-5370	DSN1229
228000-5371	DSN1229
228000-5372	DSN1229
228000-5373	DSN1229
228000-5374	DSN1229
228000-5375	DSN1229
228000-5376	DSN1229
228000-5377	DSN1229
228000-5378	DSN1229
228000-5379	DSN1229
228000-5380	DSN1229
228000-5381	DSN1229
228000-5382	DSN1229
228000-5383	DSN1229
228000-5384	DSN1229
228000-5385	DSN1229
228000-5386	DSN1229
228000-5387	DSN1229
228000-5388	DSN1229
228000-5389	DSN1229
228000-5390	DSN1229
228000-5391	DSN1229
228000-5392	DSN1229
228000-5393	DSN1229
228000-5394	DSN1229
228000-5395	DSN1229
228000-5396	DSN1229
228000-5397	DSN1229
228000-5398	DSN1229
228000-5399	DSN1229
228000-5400	DSN1229
228000-5401	DSN1229
228000-5402	DSN1229
228000-5403	DSN1229
228000-5404	DSN1229
228000-5405	DSN1229
228000-5406	DSN1229
228000-5407	DSN1229
228000-5408	DSN1229
228000-5409	DSN1229
228000-5410	DSN1229
228000-5411	DSN1229
228000-5412	DSN1229
228000-5413	DSN1229
228000-5414	DSN1229
228000-5415	DSN1229
228000-5416	DSN1229
228000-5417	DSN1229
228000-5418	DSN1229
228000-5419	DSN1229
228000-5420	DSN1229
228000-5421	DSN1229
228000-5422	DSN1229
228000-5423	DSN1229
228000-5424	DSN1229
228000-5425	DSN1229
228000-5426	DSN1229
228000-5427	DSN1229
228000-5428	DSN1229
228000-5429	DSN1229
228000-5430	DSN1229
228000-5431	DSN1229
228000-5432	DSN1229
228000-5433	DSN1229
228000-5434	DSN1229
228000-5435	DSN1229
228000-5436	DSN1229
228000-5437	DSN1229
228000-5438	DSN1229
228000-5439	DSN1229
228000-5440	DSN1229
228000-5441	DSN1229
228000-5442	DSN1229
228000-5443	DSN1229
228000-5444	DSN1229
228000-5445	DSN1229
228000-5446	DSN1229
228000-5447	DSN1229
228000-5448	DSN1229
228000-5449	DSN1229
228000-5450	DSN1229
228000-5451	DSN1229
228000-5452	DSN1229
228000-5453	DSN1229
228000-5454	DSN1229
228000-5455	DSN1229
228000-5456	DSN1229
228000-5457	DSN1229
228000-5458	DSN1229
228000-5459	DSN1229
228000-5460	

Starters & Alternators

Cross Reference Chart

DENSO	DENSO
228000-9872	DSN1389
228000-9900	DSN1003
228000-9901	DSN1003
228000-9902	DSN1003
228000-9903	DSN1003
228000-9904	DSN1003
228000-9970	DSN1457
228080-2574	DSN1225
228080-4973	DSN1224
228080-5024	DSN1211
228080-5961	DSN999
228080-5982	DSN1228
228080-7620	DSN941
228080-9201	DSN1223
228080-9872	DSN1389
228080-9970	DSN1457
260540-5000	DSN3003
260540-5010	DSN3009
260540-5020	DSN3010
260540-5030	DSN3001
260540-5040	DSN3002
260540-5050	DSN3004
260540-5060	DSN3005
260540-5070	DSN3006
260540-5080	DSN3007
260540-5090	DSN3008
260540-5100	DSN3011
260540-5110	DSN3017
260540-5120	DSN3018
260540-5130	DSN3014
260540-5140	DSN3013
260540-5150	DSN3012
260540-5160	DSN3015
260540-5170	DSN3016
428000-0010	DSN1408
428000-0020	DSN936
428000-0021	DSN936
428000-0022	DSN936
428000-0023	DSN936
428000-0024	DSN936
428000-0025	DSN936
428000-0026	DSN936
428000-0150	DSN1003
428000-0151	DSN1003
428000-0152	DSN1003
428000-0153	DSN1003
428000-0250	DSN1001
428000-0260	DSN1001
428000-0290	DSN1229
428000-0291	DSN1229
428000-0500	DSN937
428000-0570	DSN937
428000-0680	DSN920
428000-0690	DSN1370
428000-0691	DSN1370
428000-0700	DSN1370
428000-0701	DSN1370
428000-0720	DSN950
428000-1240	DSN1220
428000-1241	DSN1220
428000-1242	DSN1220
428000-1243	DSN1220
428000-1250	DSN978
428000-1350	DSN1406
428000-1360	DSN1406
428000-1630	DSN942
428000-1650	DSN3010
428000-1760	DSN1375
428000-1840	DSN1003
428000-1841	DSN1003
428000-1842	DSN1003
428000-1843	DSN1003
428000-1931	DSN1300
428000-1932	DSN1300
428000-1940	DSN944
428000-1941	DSN944
428000-2310	DSN1374
428000-2311	DSN1374
428000-2312	DSN1374
428000-2313	DSN1374
428000-2320	DSN1373

DENSO	DENSO
428000-2321	DSN1373
428000-2322	DSN1373
428000-2340	DSN1256
428000-2341	DSN1256
428000-2342	DSN1256
428000-2630	DSN1371
428000-2631	DSN1371
428000-2632	DSN1371
428000-2633	DSN1371
428000-2720	DSN926
428000-2721	DSN926
428000-2730	DSN926
428000-3090	DSN1003
428000-3091	DSN1003
428000-3092	DSN1003
428000-3110	DSN1229
428000-3111	DSN1229
428000-3180	DSN984
428000-3280	DSN1408
428000-3360	DSN948
428000-3361	DSN948
428000-3370	DSN980
428000-3371	DSN980
428000-3372	DSN980
428000-3410	DSN1391
428000-3420	DSN1391
428000-3460	DSN1398
428000-3470	DSN988
428000-3471	DSN988
428000-3472	DSN988
428000-3480	DSN948
428000-3481	DSN948
428000-3482	DSN948
428000-3970	DSN1222
428000-3971	DSN1222
428000-3972	DSN1222
428000-3980	DSN1222
428000-3981	DSN1222
428000-3982	DSN1222
428000-3983	DSN1222
428000-4050	DSN1213
428000-4051	DSN1213
428000-4052	DSN1213
428000-4053	DSN1213
428000-4110	DSN1213
428000-4111	DSN1213
428000-4112	DSN1213
428000-4113	DSN1213
428000-4114	DSN1213
428000-4140	DSN1398
428000-4350	DSN950
428000-4490	DSN1375
428000-4491	DSN1375
428000-4492	DSN1375
428000-4493	DSN1375
428000-4500	DSN920
428000-4510	DSN1370
428000-4520	DSN1390
428000-4521	DSN1390
428000-4530	DSN1370
428000-4540	DSN1390
428000-4541	DSN1390
428000-4550	DSN980
428000-4560	DSN948
428000-4561	DSN948
428000-4600	DSN968
428000-4610	DSN1207
428000-4611	DSN1207
428000-4612	DSN1207
428000-4810	DSN942
428000-4811	DSN942
428000-4840	DSN1209
428000-4841	DSN1209
428000-4850	DSN1208
428000-4851	DSN1208
428000-4880	DSN944
428000-4881	DSN944
428000-4890	DSN1300
428000-4891	DSN1300
428000-4892	DSN1300
428000-4893	DSN1300

DENSO	DENSO
428000-4920	DSN984
428000-5000	DSN1391
428000-5001	DSN1391
428000-5010	DSN1391
428000-5011	DSN1391
428000-5280	DSN1391
428000-5290	DSN1391
428000-5320	DSN1383
428000-5321	DSN1383
428000-5322	DSN1383
428000-5323	DSN1383
428000-5410	DSN1385
428000-5470	DSN926
428000-5480	DSN1377
428000-5481	DSN1377
428000-5510	DSN967
428000-5511	DSN967
428000-5580	DSN970
428000-5640	DSN1210
428000-5641	DSN1210
428000-5642	DSN1210
428000-5643	DSN1210
428000-5644	DSN1210
428000-5645	DSN1210
428000-5660	DSN1476
428000-5661	DSN1476
428000-5662	DSN1476
428000-5670	DSN1387
428000-5710	DSN984
428000-5780	DSN971
428000-5870	DSN1003
428000-5871	DSN1003
428000-5880	DSN1003
428000-5881	DSN1003
428000-5890	DSN1003
428000-5900	DSN1003
428000-5901	DSN1003
428000-5902	DSN1003
428000-5903	DSN1003
428000-5904	DSN1003
428000-5950	DSN976
428000-5951	DSN976
428000-5952	DSN976
428000-5953	DSN976
428000-6000	DSN986
428000-6070	DSN946
428000-6071	DSN946
428000-6120	DSN1221
428000-6121	DSN1221
428000-6130	DSN1215
428000-6131	DSN1215
428000-6180	DSN949
428000-6181	DSN949
428000-6200	DSN946
428000-6210	DSN949
428000-6211	DSN949
428000-6270	DSN949
428000-6271	DSN949
428000-6272	DSN949
428000-6280	DSN949
428000-6281	DSN949
428000-6282	DSN949
428000-6360	DSN986
428000-6370	DSN986
428000-6400	DSN1386
428000-6700	DSN963
428000-6701	DSN963
428000-6702	DSN963
428000-6770	DSN1364
428000-6830	DSN1236
428000-6831	DSN1236
428000-6840	DSN1241
428000-6841	DSN1241
428000-6910	DSN1208
428000-7030	DSN962
428000-7031	DSN962
428000-7032	DSN962
428000-7033	DSN962
428000-7034	DSN962
428000-7040	DSN1467
428000-7040	DSN964

DENSO	DENSO
428000-7041	DSN1467
428000-7041	DSN964
428000-7042	DSN1467
428000-7042	DSN964
428000-7043	DSN1467
428000-7043	DSN964
428000-7044	DSN1467
428000-7044	DSN964
428000-7220	DSN965
428000-7221	DSN965
428000-7222	DSN965
428000-7223	DSN965
428000-7224	DSN965
428000-7470	DSN975
428000-7480	DSN1003
428000-7481	DSN1003
428000-7482	DSN1003
428000-7483	DSN1003
428000-7490	DSN1003
428000-7491	DSN1003
428000-7492	DSN1003
428000-7493	DSN1003
428000-7500	DSN1003
428000-7501	DSN1003
428000-7502	DSN1003
428000-7503	DSN1003
428000-7700	DSN987
428000-7701	DSN987
428000-7702	DSN987
428000-7703	DSN987
428000-7704	DSN987
428000-7710	DSN920
428000-7720	DSN1370
428000-7730	DSN984
428000-7740	DSN921
428000-7750	DSN934
428000-7760	DSN931
428000-7770	DSN922
428000-7780	DSN923
428000-7790	DSN929
428000-7800	DSN935
428000-7810	DSN926
428000-7820	DSN937
428000-7830	DSN936
428000-7840	DSN931
428000-7850	DSN928
428000-7880	DSN994
428000-7881	DSN994
428000-7882	DSN994
428000-7883	DSN994
428000-7884	DSN994
428000-7885	DSN994
428000-7886	DSN994
428000-7900	DSN1009
428000-7901	DSN1009
428000-7902	DSN1009
428000-7903	DSN1009
428000-7904	DSN1009
428000-7905	DSN1009
428000-7910	DSN1009
428000-7911	DSN1009
428000-7912	DSN1009
428000-7913	DSN1009
428000-7914	DSN1009
428000-7915	DSN1009
428000-7920	DSN1204
428000-7921	DSN1204
428000-7922	DSN1204
428000-7923	DSN1204
428000-7924	DSN1204
428000-7925	DSN1204
428000-7926	DSN1204
428000-7930	DSN1201
428000-7931	DSN1201
428000-7932	DSN1201
428000-7933	DSN1201
428000-7934	DSN1201
428000-7935	DSN1201
428000-7936	DSN1201
428000-7937	DSN1201
428000-8030	DSN1008

Starters & Alternators

Cross Reference Chart

DENSO	DENSO
428000-8040	DSN1203
428000-8041	DSN1203
428000-8042	DSN1203
428000-8043	DSN1203
428000-8044	DSN1203
428000-8045	DSN1203
428000-8230	DSN948
428000-8320	DSN1464
428000-8321	DSN1464
428000-8322	DSN1464
428000-8323	DSN1464
428000-8324	DSN1464
428000-8331	DSN1368
428000-8332	DSN1368
428000-8340	DSN1239
428000-8341	DSN1239
428000-8380	DSN987
428000-8381	DSN987
428000-8410	DSN1487
428000-8411	DSN1487
428000-8420	DSN1384
428000-8421	DSN1384
428000-8422	DSN1384
428000-8423	DSN1384
428000-8424	DSN1384
428000-8430	DSN1009
428000-8431	DSN1009
428000-8432	DSN1009
428000-8433	DSN1009
428000-8434	DSN1009
428000-8440	DSN1009
428000-8441	DSN1009
428000-8442	DSN1009
428000-8443	DSN1009
428000-8444	DSN1009
428000-8530	DSN1378
428000-8570	DSN986
428000-8580	DSN986
428000-8590	DSN986
428000-8630	DSN988
428000-8710	DSN1236
428000-8711	DSN1236
428000-8850	DSN1468
428000-8851	DSN1468
428000-8852	DSN1468
428000-8853	DSN1468
428000-8860	DSN1467
428000-8861	DSN1467
428000-8862	DSN1467
428000-8863	DSN1467
428000-8980	DSN986
428000-8990	DSN986
428000-9000	DSN986
428000-9060	DSN1234
428000-9061	DSN1234
428000-9070	DSN1238
428000-9071	DSN1238
428000-9072	DSN1238
428000-9073	DSN1238
428000-9080	DSN989
428000-9130	DSN1376
428000-9131	DSN1376
428000-9140	DSN1206
428000-9200	DSN1301
428000-9210	DSN1205
428000-9211	DSN1205
428000-9212	DSN1205
428000-9310	DSN1373
428000-9320	DSN967
428000-9370	DSN934
428000-9480	DSN1235
428000-9481	DSN1235
428000-9482	DSN1235
428000-9510	DSN1420
428000-9530	DSN1204
428000-9531	DSN1204
428000-9532	DSN1204
428000-9533	DSN1204
428000-9534	DSN1204
428000-9535	DSN1204

DENSO	DENSO
428000-9580	DSN1418
428000-9581	DSN1418
428000-9582	DSN1418
428000-9583	DSN1418
428000-9610	DSN1412
428000-9611	DSN1412
428000-9612	DSN1412
428000-9620	DSN1419
428000-9660	DSN989
428000-9710	DSN1415
428000-9711	DSN1415
428000-9712	DSN1415
428000-9740	DSN1453
428080-0260	DSN1001
428080-1243	DSN1220
428080-1250	DSN978
428080-1350	DSN1406
428080-2313	DSN1374
428080-2342	DSN1256
428080-2633	DSN1371
428080-3111	DSN1229
428080-3280	DSN1408
428080-3982	DSN1222
428080-4114	DSN1213
428080-4140	DSN1398
428080-4493	DSN1375
428080-4541	DSN1390
428080-4550	DSN980
428080-4600	DSN968
428080-4612	DSN1207
428080-4811	DSN942
428080-4841	DSN1209
428080-4882	DSN944
428080-5280	DSN1391
428080-5323	DSN1383
428080-5410	DSN1385
428080-5480	DSN1377
428080-5511	DSN967
428080-5580	DSN970
428080-5645	DSN1210
428080-5662	DSN1476
428080-5670	DSN1387
428080-5780	DSN971
428080-5954	DSN976
428080-6121	DSN1221
428080-6131	DSN1215
428080-6400	DSN1386
428080-6702	DSN963
428080-6770	DSN1364
428080-6841	DSN1241
428080-6910	DSN1208
428080-7030	DSN962
428080-7040	DSN1467
428080-7040	DSN964
428080-7224	DSN965
428080-7493	DSN1003
428080-7504	DSN1003
428080-7887	DSN994
428080-7926	DSN1204
428080-7937	DSN1201
428080-8030	DSN1008
428080-8045	DSN1203
428080-8332	DSN1368
428080-8341	DSN1239
428080-8381	DSN987
428080-8423	DSN1384
428080-8445	DSN1009
428080-8531	DSN1378
428080-8711	DSN1236
428080-8853	DSN1468
428080-8863	DSN1467
428080-9061	DSN1234
428080-9073	DSN1238
428080-9081	DSN989
428080-9131	DSN1376
428080-9200	DSN1301
428080-9310	DSN1373
428080-9482	DSN1235
428080-9510	DSN1420
428080-9583	DSN1418
428080-9620	DSN1419

DENSO	DENSO
428080-9712	DSN1415
428080-9740	DSN1453
438000-0090	DSN1205
438000-0091	DSN1205
438000-0190	DSN1466
438000-0191	DSN1466
438000-0192	DSN1466
438000-0200	DSN1465
438000-0201	DSN1465
438000-0202	DSN1465
438000-0210	DSN1464
438000-0211	DSN1464
438000-0212	DSN1464
438000-0220	DSN1463
438000-0221	DSN1463
438000-0230	DSN1462
438000-0231	DSN1462
438000-0240	DSN1461
438000-0241	DSN1461
438000-0250	DSN1460
438000-0251	DSN1460
438000-0640	DSN1239
438000-0820	DSN1365
438000-0821	DSN1365
438000-0822	DSN1365
438000-1510	DSN1417
438000-1511	DSN1417
438000-1512	DSN1417
438000-1530	DSN1410
438000-1531	DSN1410
438000-1532	DSN1410
438000-1540	DSN1416
438000-1541	DSN1416
438000-1542	DSN1416
438000-1550	DSN1411
438000-1551	DSN1411
438000-1552	DSN1411
438000-1660	DSN1472
438000-1670	DSN1473
438000-1970	DSN1425
438000-1971	DSN1425
438000-1972	DSN1425
438000-1980	DSN1424
438000-1981	DSN1424
438000-1982	DSN1424
438000-1990	DSN1423
438000-1991	DSN1423
438000-1992	DSN1423
438000-1993	DSN1423
438000-2000	DSN1422
438000-2001	DSN1422
438000-2002	DSN1422
438000-2003	DSN1422
438000-2020	DSN1205
438000-2021	DSN1205
438000-2040	DSN1445
438000-2050	DSN1206
438000-2460	DSN1475
438000-3000	DSN1421
438080-0192	DSN1466
438080-0202	DSN1465
438080-0212	DSN1464
438080-0221	DSN1463
438080-0231	DSN1462
438080-0241	DSN1461
438080-0251	DSN1460
438080-0822	DSN1365
438080-1512	DSN1417
438080-1542	DSN1416
438080-1972	DSN1425
438080-1982	DSN1424
438080-1993	DSN1423
438080-2003	DSN1422
438080-2040	DSN1445
438080-3000	DSN1421
54000000	DAN005
54022570	DAN005
54022611	DAN005
63103022	DSN577
63111007	DSN579
63321152	DAN615

DENSO	DENSO
63321227	DAN628
63321232	DAN1140
63321257	DAN504
63321313	DAN1037
63321316	DAN1037
63321332	DAN628
63321418	DAN1140
63321497	DAN501
63321507	DAN502
63321604	DAN629
63321618	DAN628
63321666	DAN504
63321678	DAN562
63321695	DAN504
63321715	DAN629
63321718	DAN517
63321729	DAN1037
63321730	DAN047
63321733	DAN1336
63321734	DAN1336
63321740	DAN1063
63321741	DAN1063
63321746	DAN1124
63321747	DAN630
63321760	DAN631
63321765	DAN519
63321775	DAN519
63321776	DAN599
63321800	DAN632
63321801	DAN1140
63321802	DAN1037
63321810	DAN1037
63321819	DAN520
63321823	DAN1124
63321826	DAN501
63321828	DAN515
63321829	DAN515
63321833	DAN640
63321858	DAN641
63321859	DAN502
63321898	DAN562
63341695	DAN504
63341730	DAN047
63341733	DAN1336
63341734	DAN1336
63341740	DAN1063

DENSO Europe B.V.
Hogesweyselaan 165
1382 JL Weesp
The Netherlands

Tel: +31 (0)294 493 493
Fax: +31 (0)294 417 122

www.denso-am.eu